

Folha de dados | Número do item: 750-502/000-800

Saída digital de 2 canais; 24 V DC; 2,0 A; Livre de Interferências; cinza claro

[www.wago.com/750-502/000-800](http://www.wago.com/750-502/000-800)

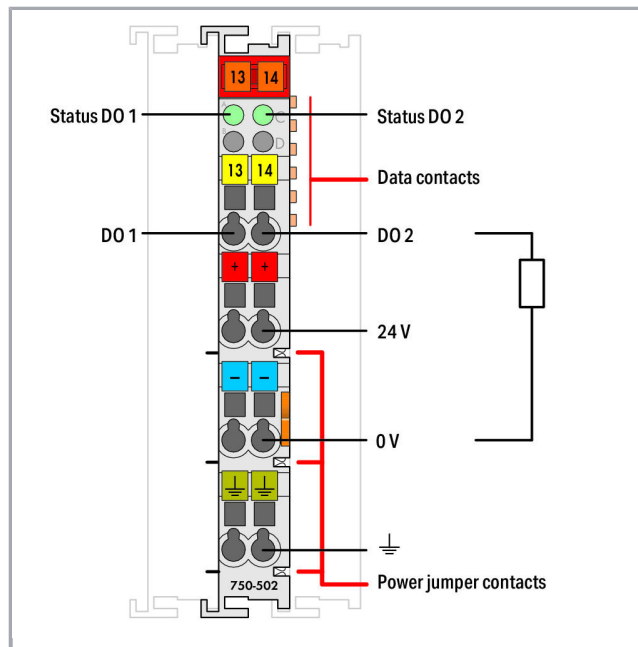
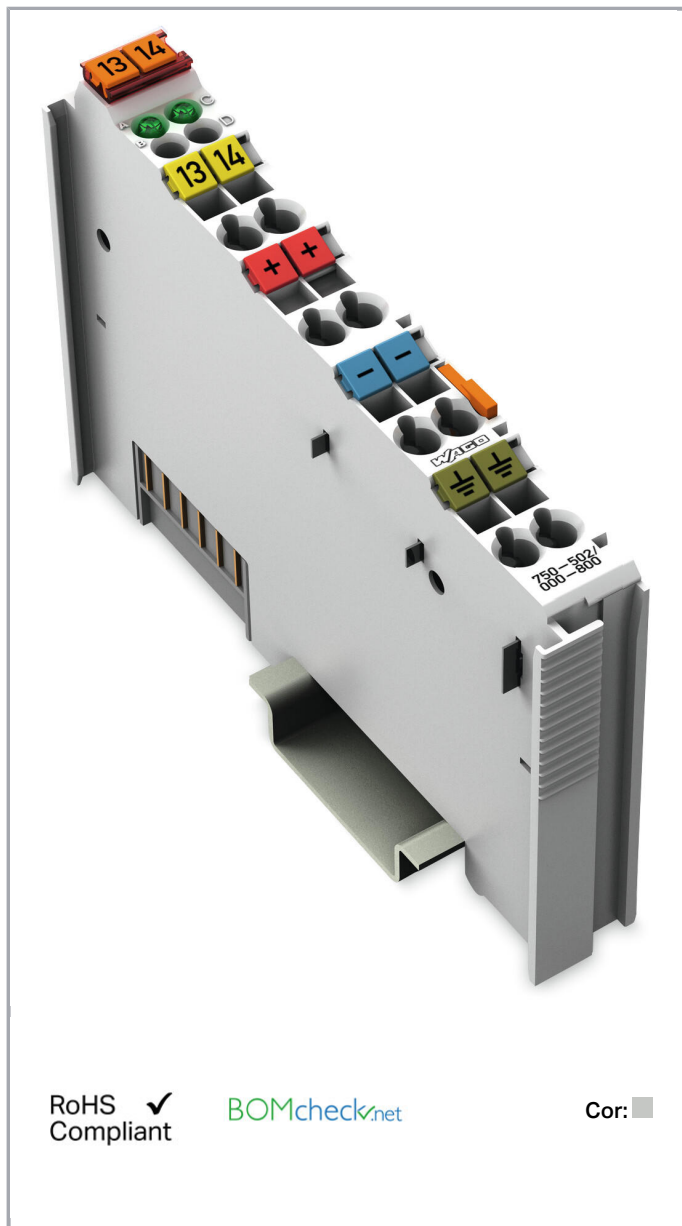

RoHS Compliant

Cor:

Sujeito a alterações.

WAGO Eletroeletrônicos Ltda  
Rua Trípoli, 640, Loteamento Multivias II  
Jardim Ermida I, Jundiaí - SP, CEP: 13212-217  
Tel.: +55 (11) 2923-7256  
Email: info.br@wago.com

Alguma dúvida sobre nossos produtos?  
Será um prazer atender a sua chamada no +55 11 99389-8818.

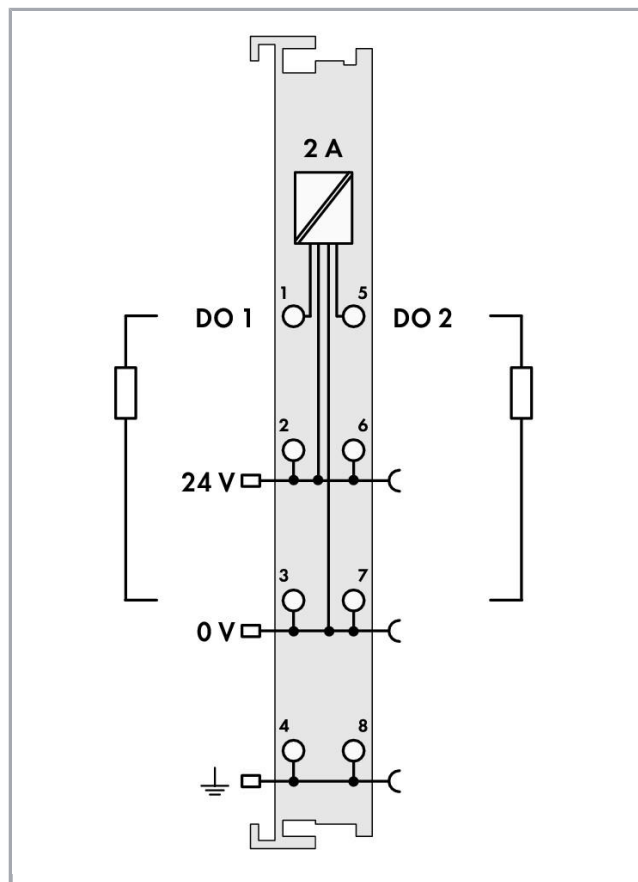
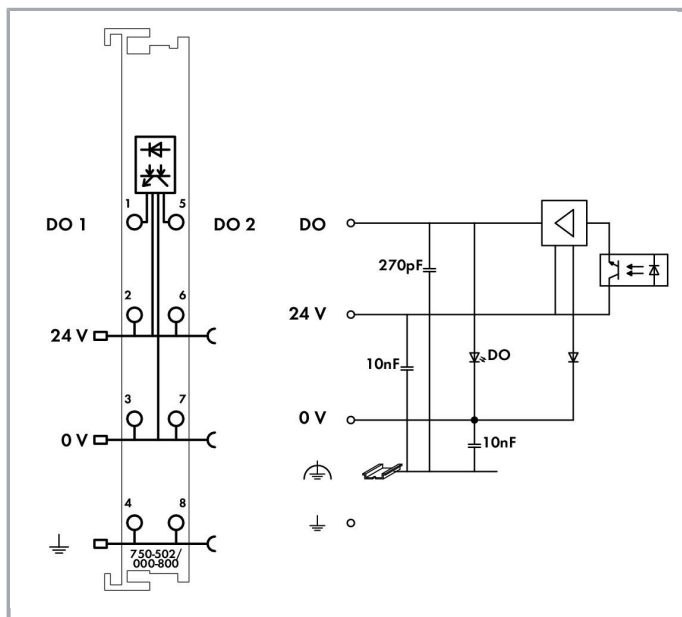

## Descrição do item

Sinais de controle são transmitidos do dispositivo de automação aos atuadores conectados através do módulo de saída digital.

Todas as saídas são à prova de curto-circuito.

Os níveis de campo e do sistema são isolados eletricamente.

## Dados

### Dados técnicos

Número de saídas digitais	2
Número total de canais (módulo)	2
Tipo de sinal	Voltage
Type of signal voltage	DC 24 V
Conexão do atuador	2 x (2 condutores, 3 condutores, 4 condutores)
Carcaterística de saída	comutação de lado alto
Corrente de saída por canal	2 A

Sujeito a alterações.

WAGO Eletroeletrônicos Ltda  
 Rua Trípoli, 640, Loteamento Multivias II  
 Jardim Ermida I, Jundiaí - SP, CEP: 13212-217  
 Tel.: +55 (11) 2923-7256  
 Email: info.br@wago.com

Alguma dúvida sobre nossos produtos?  
 Será um prazer atender a sua chamada no +55 11 99389-8818.



Corrente de saída	short-circuit-protected
Frequência da comutação máx.	2,5 kHz
Tipo de carga	resistivo, indutivo, lâmpadas
Limitação de curto-circuito tip. Pwm (A)	35 A
Energia absorvível máx. (desativação única)	0,14 J
Largura de dados Dados de saída (inter.) máx.	2 Bit
Tensão de alimentação do sistema	DC 5 V; via data contacts
Consumo de corrente, alimentação do sistema (5 V)	3,5 mA
Tensão de alimentação de campo	DC 24 V (-25 ... +30 %); über Leistungskontakte (Einspeisung über Messerkontakt; Weiterleitung über Federkontakt)
Consumo de corrente, alimentação do campo (módulo sem carga externa)	15 mA
Isolamento	500 V (sistema/alimentação)
Não reativo à função de segurança	sim
Indicadores	LED (A, C) verde: Status DO 1, DO 2
Quantidade de contatos de potência de entrada	3
Quantidade de contatos de potência de saída	3
Capacidade de carga de corrente dos contatos de potência	10 A

### Dados de conexão

Connection technology: In-/Outputs	8 x CAGE CLAMP®
Tipo de conexão (1)	Inputs/Outputs
Condutor sólido	0,08 ... 2,5 mm <sup>2</sup> / 28 ... 14 AWG
Condutor flexível	0,08 ... 2,5 mm <sup>2</sup> / 28 ... 14 AWG
Comprimento do desencape	8 ... 9 mm / 0.31 ... 0.35 polegada

### Dados geométricos

Largura	12 mm / 0.472 inch
Altura	69,8 mm / 2.748 inch
Altura da borda superior do trilho DIN -35	62,6 mm / 2.465 inch
Profundidade	100 mm / 3.937 inch

### Dados mecânicos

Tipo de montagem	Trilho DIN 35
------------------	---------------

Sujeito a alterações.

WAGO Eletroeletrônicos Ltda  
 Rua Trípoli, 640, Loteamento Multivias II  
 Jardim Ermida I, Jundiá - SP, CEP: 13212-217  
 Tel.: +55 (11) 2923-7256  
 Email: info.br@wago.com

Alguma dúvida sobre nossos produtos?  
 Será um prazer atender a sua chamada no +55 11 99389-8818.



## Dados do Material

Cor	cinza claro
Material da carcaça	Polycarbonate, polyamide 6.6
Carga de fogo	1,139 MJ
Peso	47,1 g
Identificação de conformidade	CE

## Condições ambientais

Temperatura (operacional) do ambiente	0 ... 55 °C
Temperatura ambiente (armazenamento)	-40 ... 85 °C
Grau de proteção	IP20
Grau de poluição (5)	2 per IEC 61131-2
Altitude operacional	0 ... 2000 m
Posição de montagem	horizontal (standing/lying) or vertical
Umidade relativa do ar (sem condensação)	95 %
Resistência a vibrações	4g per IEC 60068-2-6
Resistência ao choque	15g per IEC 60068-2-27
À prova de interferências EMC	acc. to EN 61000-6-2, marine applications
EMC: 1 - emissão de interferência	acc. to EN 61000-6-4, marine applications
Exposição a poluentes	Per IEC 60068-2-42 and IEC 60068-2-43
Concentração admissível de poluentes H <sub>2</sub> S em umidade relativa de 75 %	10 ppm
Concentração admissível de poluentes SO <sub>2</sub> em umidade relativa de 75 %	25 ppm

## Dados Comerciais

Grupo de produto	15 (Remote I/O)
Tipo de embalagem	BOX
País de origem	DE
GTIN	4045454870478
Customs Tariff No.	85371098990

## Certificações



### Aprovações Ex

Nome do

Sujeito a alterações.

WAGO Eletroeletrônicos Ltda  
 Rua Trípoli, 640, Loteamento Multivias II  
 Jardim Ermida I, Jundiaí - SP, CEP: 13212-217  
 Tel.: +55 (11) 2923-7256  
 Email: info.br@wago.com

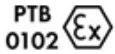



Alguma dúvida sobre nossos produtos?  
 Será um prazer atender a sua chamada no +55 11 99389-8818.

Logotipo	Certificação	Informações Adicionais	Certificado
	ATEX TUEV Nord Cert GmbH	EN 60079-0	TÜV 07 ATEX 554086 X en.
	TUEV Nord TUEV Nord Cert GmbH	IEC 60079-0	IECEX TUN 09.0001 X
	UL Underwriters Laboratories Inc. (HAZARDOUS LOCATIONS)	UL 121201	E198726 Sec.1

**Certificações específicas do país**

Logotipo	Certificação	Informações Adicionais	Nome do Certificado
	KC National Radio Research Agency	Article 58-2, Clause 3	MSIP-REM- W43- DOM750

**Certificações navais**

Logotipo	Certificação	Informações Adicionais	Nome do Certificado
	ABS American Bureau of Shipping	-	19- HG1821926
	BV Bureau Veritas S.A.	-	30389/B0 BV
	DNV GL Det Norske Veritas, Germanischer Lloyd	-	TAA0000194
	KR Korean Register of Shipping	-	KR HMB05880- AC001
	LR Lloyds Register	-	02/20026 (E6)

Sujeito a alterações.

WAGO Eletroeletrônicos Ltda  
Rua Trípoli, 640, Loteamento Multivias II  
Jardim Ermida I, Jundiaí - SP, CEP: 13212-217  
Tel.: +55 (11) 2923-7256  
Email: info.br@wago.com

Alguma dúvida sobre nossos produtos?  
Será um prazer atender a sua chamada no +55 11 99389-8818.



**PRS**  
Polski Rejestr Statków

-

TE/2236  
/880590/19



**RINA**  
RINA Germany GmbH

-

ELE066419XG

#### Certificações UL

Logotipo	Certificação	Informações Adicionais	Nome do Certificado
	<b>UL</b> UL International Netherlands B.V. (ORDINARY LOCATIONS)	UL 508	E175199 Sec.1

#### Counterpart

#### Produtos Compatíveis

#### Carrier rail















<b>Nº. do item: 210-112</b> Steel carrier rail; 35 x 7.5 mm; 1 mm thick; 2 m long; slotted; according to EN 60715; "Hole width 25 mm	<a href="http://www.wago.com/210-112">www.wago.com/210-112</a>
<b>Nº. do item: 210-113</b> Trilho de montagem em aço; 35 x 7,5 mm; 1 mm de espessura; 2 m de comprimento; sem furo; de acordo com a EN 60715	<a href="http://www.wago.com/210-113">www.wago.com/210-113</a>
<b>Nº. do item: 210-114</b> Steel carrier rail; 35 x 15 mm; 1.5 mm thick; 2 m long; unslotted; similar to EN 60715	<a href="http://www.wago.com/210-114">www.wago.com/210-114</a>
<b>Nº. do item: 210-115</b> Trilho de montagem em aço; 35 x 7,5 mm; 1 mm de espessura; 2 m de comprimento; fendado; de acordo com a EN 60715; Largura do furo 18 mm	<a href="http://www.wago.com/210-115">www.wago.com/210-115</a>
<b>Nº. do item: 210-118</b> Trilho de montagem em aço; 35 x 15 mm; 2,3 mm de espessura; 2 m de comprimento; sem furo; de	<a href="http://www.wago.com/210-118">www.wago.com/210-118</a>

Sujeito a alterações.

WAGO Eletroeletrônicos Ltda  
Rua Trípoli, 640, Loteamento Multivias II  
Jardim Ermida I, Jundiaí - SP, CEP: 13212-217  
Tel.: +55 (11) 2923-7256  
Email: [info.br@wago.com](mailto:info.br@wago.com)















Alguma dúvida sobre nossos produtos?  
Será um prazer atender a sua chamada no +55 11 99389-8818.

acordo com a EN 60715

	<b>Nº. do item: 210-196</b> Trilho de montagem em alumínio; 35 x 8,2 mm; 1,6 mm de espessura; 2 m de comprimento; sem furo; similar à EN 60715; prateado	<a href="http://www.wago.com/210-196">www.wago.com/210-196</a>
	<b>Nº. do item: 210-197</b> Trilho de montagem em aço; 35 x 15 mm; 1,5 mm de espessura; 2 m de comprimento; fendado; similar à EN 60715	<a href="http://www.wago.com/210-197">www.wago.com/210-197</a>
	<b>Nº. do item: 210-198</b> Copper carrier rail; 35 x 15 mm; 2.3 mm thick; 2 m long; unslotted; according to EN 60715; copper-colored	<a href="http://www.wago.com/210-198">www.wago.com/210-198</a>
	<b>Nº. do item: 210-504</b> Trilho de montagem em aço; 35 x 7,5 mm; 1 mm de espessura; 2 m de comprimento; fendado; galvanizado; de acordo com a EN 60715	<a href="http://www.wago.com/210-504">www.wago.com/210-504</a>
	<b>Nº. do item: 210-505</b> Steel carrier rail; 35 x 7.5 mm; 1 mm thick; 2 m long; unslotted; galvanized; according to EN 60715	<a href="http://www.wago.com/210-505">www.wago.com/210-505</a>
	<b>Nº. do item: 210-506</b> Steel carrier rail; 35 x 15 mm; 1.5 mm thick; 2 m long; unslotted; galvanized; similar to EN 60715	<a href="http://www.wago.com/210-506">www.wago.com/210-506</a>
	<b>Nº. do item: 210-508</b> Steel carrier rail; 35 x 15 mm; 1.5 mm thick; 2 m long; slotted; galvanized; similar to EN 60715	<a href="http://www.wago.com/210-508">www.wago.com/210-508</a>
<b>shield connection</b>		
	<b>Nº. do item: 790-108</b> Grampo de fixação de blindagem; 11 mm de largura; diâmetro do condutor compatível; 3 ... 8 mm	<a href="http://www.wago.com/790-108">www.wago.com/790-108</a>
	<b>Nº. do item: 790-116</b> Shield clamping saddle; 19 mm wide; diameter of compatible conductor; 7 ... 16 mm	<a href="http://www.wago.com/790-116">www.wago.com/790-116</a>
	<b>Nº. do item: 790-124</b> Grampo de fixação de blindagem; 27 mm de largura; diâmetro do condutor compatível; 6 ... 24 mm	<a href="http://www.wago.com/790-124">www.wago.com/790-124</a>
	<b>Nº. do item: 790-140</b> Shield clamping saddle; diameter of compatible conductor	<a href="http://www.wago.com/790-140">www.wago.com/790-140</a>
	<b>Nº. do item: 790-208</b> Shield clamping saddle; 12.4 mm wide; 3 ... 8 mm	<a href="http://www.wago.com/790-208">www.wago.com/790-208</a>
	<b>Nº. do item: 790-216</b> Grampo de fixação de blindagem; 21,8 mm de largura; 6 ... 16 mm	<a href="http://www.wago.com/790-216">www.wago.com/790-216</a>
	<b>Nº. do item: 790-220</b> Shield clamping saddle; 30 mm wide; 6 ... 20 mm	<a href="http://www.wago.com/790-220">www.wago.com/790-220</a>
<b>system box</b>		
	<b>Nº. do item: 850-804</b> Carcaça IP 65; Aço inoxidável; L x A x P (400 x 123 x 200 mm); Garra do cabo 4 x M20, 16 x M16, 28 x M12	<a href="http://www.wago.com/850-804">www.wago.com/850-804</a>

**Nº. do item: 850-804/000-001**

Sujeito a alterações.

	Carcaça IP 65; Aço inoxidável; L x A x P (400 x 123 x 200 mm); Garra do cabo 2 x M20, 13 x M16, 32 x M12	<a href="http://www.wago.com/850-804/000-001">www.wago.com/850-804/000-001</a>
	<b>Nº. do item: 850-805</b> Carcaça IP 65; Aço inoxidável; L x A x P (600 x 123 x 200 mm); Garra do cabo 4 x M20, 19 x M16, 67 x M12	<a href="http://www.wago.com/850-805">www.wago.com/850-805</a>
	<b>Nº. do item: 850-814/002-000</b> Carcaça IP 65; Folha de aço (RAL 7035); L x A x P (200 x 120 x 200 mm); sem placa de flange	<a href="http://www.wago.com/850-814/002-000">www.wago.com/850-814/002-000</a>
	<b>Nº. do item: 850-815/002-000</b> Carcaça IP 65; Folha de aço (RAL 7035); L x A x P (300 x 120 x 200 mm); sem placa de flange	<a href="http://www.wago.com/850-815/002-000">www.wago.com/850-815/002-000</a>
	<b>Nº. do item: 850-816/002-000</b> IP65 enclosure; Sheet steel (RAL 7035); WxHxD (400x120x200 mm); without flange plate	<a href="http://www.wago.com/850-816/002-000">www.wago.com/850-816/002-000</a>
	<b>Nº. do item: 850-817/002-000</b> IP65 enclosure; Sheet steel (RAL 7035); WxHxD (600x120x200 mm); without flange plate	<a href="http://www.wago.com/850-817/002-000">www.wago.com/850-817/002-000</a>
	<b>Nº. do item: 850-825</b> Carcaça IP 65; Alumínio (RAL 7032); L x A x P (160 x 100 x 160 mm); 9 x M12, 4 x M20	<a href="http://www.wago.com/850-825">www.wago.com/850-825</a>
	<b>Nº. do item: 850-826</b> Carcaça IP 65; Alumínio (RAL 7032); L x A x P (240 x 100 x 160 mm); Garra do cabo 4 x M20, 4 x M16, 14 x M12	<a href="http://www.wago.com/850-826">www.wago.com/850-826</a>
	<b>Nº. do item: 850-826/002-000</b> Carcaça IP 65; Alumínio (RAL 7035); L x A x P (240 x 100 x 160 mm); Garra do cabo 4 x M20, 4 x M16, 14 x M12	<a href="http://www.wago.com/850-826/002-000">www.wago.com/850-826/002-000</a>
	<b>Nº. do item: 850-827</b> IP65 enclosure; Aluminium (RAL 7032); WxHxD (320x100x160 mm); 4 x M20, 8 x M16, 17 x M12 cable grip	<a href="http://www.wago.com/850-827">www.wago.com/850-827</a>
	<b>Nº. do item: 850-827/002-000</b> Carcaça IP 65; Alumínio (RAL 7035); L x A x P (320 x 100 x 160 mm); Garra do cabo 4 x M20, 8 x M16, 17 x M12	<a href="http://www.wago.com/850-827/002-000">www.wago.com/850-827/002-000</a>
	<b>Nº. do item: 850-828</b> Carcaça IP 65; Alumínio (RAL 7032); L x A x P (480 x 100 x 160 mm); Garra do cabo 4 x M20, 10 x M16, 35 x M12	<a href="http://www.wago.com/850-828">www.wago.com/850-828</a>
	<b>Nº. do item: 850-828/002-000</b> Carcaça IP 65; Alumínio (RAL 7035); L x A x P (480 x 100 x 160 mm); Garra do cabo 4 x M20, 10 x M16, 35 x M12	<a href="http://www.wago.com/850-828/002-000">www.wago.com/850-828/002-000</a>
	<b>Nº. do item: 850-834</b> Carcaça IP 65; Poliéster (RAL 7032); L x A x P (164 x 100 x 164 mm); 9 x M12, 4 x M20	<a href="http://www.wago.com/850-834">www.wago.com/850-834</a>
	<b>Nº. do item: 850-835</b>	

Sujeito a alterações.





IP65 enclosure; Polyester (RAL 7032); WxHxD (244x100x164 mm); 4 x M20, 4 x M16, 14 x M12 cable grip

[www.wago.com/850-835](http://www.wago.com/850-835)



**Nº. do item: 850-836**

Carcaça IP 65; Poliéster (RAL 7032); L x A X P (324 x 100 x 164 mm); Garra do cabo 4 x M20, 8 x M16, 17 x M12

[www.wago.com/850-836](http://www.wago.com/850-836)

**Marking accessories**

**Nº. do item: 2009-145**

Mini-WSB Inline; for Smart Printer; 1700 pieces on roll; stretchable 5 - 5.2 mm; plain; snap-on type; white

[www.wago.com/2009-145](http://www.wago.com/2009-145)



**Nº. do item: 2009-145/000-002**

Mini-WSB Inline; for Smart Printer; 1700 pieces on roll; stretchable 5 - 5.2 mm; plain; snap-on type; white /000-002

[www.wago.com/2009-145](http://www.wago.com/2009-145)



**Nº. do item: 2009-145/000-005**

Mini-WSB Inline; for Smart Printer; 1700 pieces on roll; stretchable 5 - 5.2 mm; plain; snap-on type; red /000-005

[www.wago.com/2009-145](http://www.wago.com/2009-145)



**Nº. do item: 2009-145/000-006**

Mini-WSB Inline; for Smart Printer; 1700 pieces on roll; stretchable 5 - 5.2 mm; plain; snap-on type; blue /000-006

[www.wago.com/2009-145](http://www.wago.com/2009-145)



**Nº. do item: 2009-145/000-007**

Mini-WSB Inline; for Smart Printer; 1700 pieces on roll; stretchable 5 - 5.2 mm; plain; snap-on type; white /000-007

[www.wago.com/2009-145](http://www.wago.com/2009-145)



**Nº. do item: 2009-145/000-012**

Mini-WSB Inline; for Smart Printer; 1700 pieces on roll; stretchable 5 - 5.2 mm; plain; snap-on type; orange

[www.wago.com/2009-145](http://www.wago.com/2009-145)



**Nº. do item: 2009-145/000-023**

Mini-WSB Inline; for Smart Printer; 1700 pieces on roll; stretchable 5 - 5.2 mm; plain; snap-on type; green

[www.wago.com/2009-145](http://www.wago.com/2009-145)



**Nº. do item: 2009-145/000-024**

Mini-WSB Inline; for Smart Printer; 1700 pieces on roll; stretchable 5 - 5.2 mm; plain; snap-on type; violet

[www.wago.com/2009-145](http://www.wago.com/2009-145)



**Nº. do item: 248-501**

Sistema rápido de identificação Mini WSB; liso; Largura do marcador 5 mm; 10 faixas c/ 10 identificadores p cartão

[www.wago.com/248-501](http://www.wago.com/248-501)



**Nº. do item: 248-501/000-002**

Cartão de identificação Mini WSB; como cartão; not stretchable; liso; tipo encaixe; amarelo

[www.wago.com/248-501](http://www.wago.com/248-501)



**Nº. do item: 248-501/000-005**

Cartão de identificação Mini WSB; como cartão; not stretchable; liso; tipo encaixe; vermelho

[www.wago.com/248-501](http://www.wago.com/248-501)



**Nº. do item: 248-501/000-006**

Cartão de identificação Mini WSB; como cartão; not stretchable; liso; tipo encaixe; azul

[www.wago.com/248-501](http://www.wago.com/248-501)

Sujeito a alterações.

WAGO Eletroeletrônicos Ltda  
Rua Trípoli, 640, Loteamento Multivias II  
Jardim Ermida I, Jundiaí - SP, CEP: 13212-217  
Tel.: +55 (11) 2923-7256  
Email: [info.br@wago.com](mailto:info.br@wago.com)

Alguma dúvida sobre nossos produtos?  
Será um prazer atender a sua chamada no +55 11 99389-8818.



Nº. do item: 248-501/000-007

Cartão de identificação Mini WSB; como cartão; not stretchable; liso; tipo encaixe; cinza

[www.wago.com/248-501/000-007](http://www.wago.com/248-501/000-007)



Nº. do item: 248-501/000-012

Mini-WSB marking card; as card; not stretchable; plain; snap-on type; orange

[www.wago.com/248-501/000-012](http://www.wago.com/248-501/000-012)



Nº. do item: 248-501/000-017

Cartão de identificação Mini WSB; como cartão; not stretchable; liso; tipo encaixe; verde claro

[www.wago.com/248-501/000-017](http://www.wago.com/248-501/000-017)



Nº. do item: 248-501/000-023

Cartão de identificação Mini WSB; como cartão; not stretchable; liso; tipo encaixe; verde

[www.wago.com/248-501/000-023](http://www.wago.com/248-501/000-023)



Nº. do item: 248-501/000-024

Cartão de identificação Mini WSB; como cartão; not stretchable; liso; tipo encaixe; violeta

[www.wago.com/248-501/000-024](http://www.wago.com/248-501/000-024)



Nº. do item: 750-100

Marker card; as a DIN A4 sheet; plain; white

[www.wago.com/750-100](http://www.wago.com/750-100)



Nº. do item: 750-103

Group marker carrier; transparent

[www.wago.com/750-103](http://www.wago.com/750-103)



Nº. do item: 750-106

Group marker carrier; transparent

[www.wago.com/750-106](http://www.wago.com/750-106)

#### Supply module



Nº. do item: 750-601

Fonte de Alimentação; 24 V DC; Suporte de fusíveis; cinza claro

[www.wago.com/750-601](http://www.wago.com/750-601)



Nº. do item: 750-602

Fonte de Alimentação; 24 V DC; cinza claro

[www.wago.com/750-602](http://www.wago.com/750-602)



Nº. do item: 750-610

Fonte de Alimentação; 24 V DC; Suporte de fusíveis; Diagnósticos

[www.wago.com/750-610](http://www.wago.com/750-610)



Nº. do item: 750-612

Fonte de Alimentação; 0 ... 230 V AC/DC; cinza claro

[www.wago.com/750-612](http://www.wago.com/750-612)

## Downloads

### Documentação

#### Manual

2-channel, 24VDC, 2.0A

V 1.2.0

pdf

Download

short-circuit protected, high-side switching

851,9 kB

#### Informações adicionais

Sujeito a alterações.

WAGO Eletroeletrônicos Ltda  
Rua Trípoli, 640, Loteamento Multivias II  
Jardim Ermida I, Jundiá - SP, CEP: 13212-217  
Tel.: +55 (11) 2923-7256  
Email: [info.br@wago.com](mailto:info.br@wago.com)

Alguma dúvida sobre nossos produtos?  
Será um prazer atender a sua chamada no +55 11 99389-8818.



Disposal; Electrical and electronic equipment, Packaging	V 1.0.0	pdf 265,8 kB	Download
<b>Descrição do sistema</b>			
750/753 Series I/O-System – General Product Information		pdf 1,7 MB	Download
Overview on WAGO-I/O-SYSTEM 750 approvals		pdf 780,2 kB	Download
Design Notes	V 2.0.0	pdf 1,5 MB	Download
Basic conditions and recommendations for higher operational safety			
Use in Hazardous Environments			Download
Term definition, marking and installation regulations			

## Dados CAx

### Dados CAD

2D/3D Models 750-502/000-800		URL	Download
<b>CAE data</b>			
EPLAN Data Portal 750-502/000-800		URL	Download
WSCAD Universe 750-502/000-800		URL	Download

## Device Files

### Driver de dispositivo

WAGO USB Service Kabel Treiber / Serie 750 und 857	6.5.3.0 10/09/2014	zip 4,8 MB	Download
--	-----------------------	---------------	----------

## Installation Notes

## Linha de produtos

**Sistemas de I/O - 750/753**  
[Mostrar todos os produtos da linha](#)

Sujeito a alterações.