



S3Z

Advanced line of miniature Asian style of photoelectric sensors

- 50-250 mm background suppression
- 0.7 m proximity, 150 mm with narrow beam
- 4 m polarized retroreflective
- 15 m through beam
- Standard 3-wire output configuration



SENSORS

APPLICATIONS

- Processing and Packaging machinery
- Electronics assembling
- Transportation lines, material handling
- Automatic warehouses
- Cosmetics and Pharmaceutical industry
- Small part detection with maximum accuracy



S3Z		
Through beam		0...15 m 0...30 m (class 1 LASER)
Polarized retroreflective		0.05...4 m 0,3...10 m (class 1 LASER)
Retroreflective for transparent (on R2 reflector)		0...2 m
Diffuse proximity		0...700 mm 50...150 mm (narrow beam)
Background suppression		50...250 mm 40...300 mm (class 1 LASER)
Power supply	Vdc	10...30 V
	Vac	
	Vac/dc	
Output	PNP	▪
	NPN	▪
	NPN/PNP	
	relay	
	other	
Connection	cable	▪
	connector	▪
	pig-tail	
Approximate dimensions (mm)		11x31x19
Housing material		PC/PBT
Mechanical protection		IP67

TECHNICAL DATA	
Consumption (output current excluded)	30 mA max. (LED mod.) 35 mA max. (Laser mod.)
Light emission	red LED 650 nm (mod. S3Z...T51) red LED 665 nm (mod. S3Z...B01/C01) red LED 670 nm (mod. S3Z...M01) IR LED 850 nm (mod. S3Z...C11) IR LED 870 nm (mod. S3Z...F01/G00) red Laser 650 nm (mod. S3Z...B01/F01/G00/M01)
Setting	sensitivity trimmer, 6 turns screw (mod. S3Z...M01)
Operating mode	LIGHT/DARK trimmer (Laser mod.), LIGHT (mod. S3Z...-PL, -NL), DARK (mod. S3Z...-PD, -ND)
Indicators	yellow OUTPUT LED, green STABILITY LED (mod. S3Z...B01/C01/C11/F01), POWER ON LED (mod. S3Z...G00)
Output	PNP or NPN (short circuit protection)
Output current	100 mA max.
Saturation voltage	2 V max. (LED mod.) 1,5 V max. (Laser mod.)
Response time	1 ms max. (LED mod.) 250 µs max. (Laser mod.)
Switching frequency	500 Hz max. (LED mod.) 2 kHz max. (Laser mod.)
Connection	2 m cable Ø 3,5 mm, M8 4-pole connector
Dielectric strength	500 Vac 1 min., between electronics and housing
Insulating resistance	>20 MΩ 500 Vdc, between electronics and housing
Mechanical protection	IP67
Ambient light rejection	according to EN 60947-5-2
Vibration	0,5 mm amplitude, 10 ... 55 Hz frequency, for every axis (EN60068-2-6)
Shock resistance	11 ms (30 G) 6 shock for every axis (EN60068-2-27)
Housing material	body PBT, indicators cover PC
Lens material	PMMA, PC (mod. S3Z...B01)
Operating temperature	-25 ... 55 °C (LED mod.), -10 ... 55 °C (Laser mod.)
Storage temperature	-40 ... 70 °C (LED mod.), -25 ... 70 °C (Laser mod.)
Weight	50 g max. cable vers., 10 g max. conn. vers.

DIMENSIONS

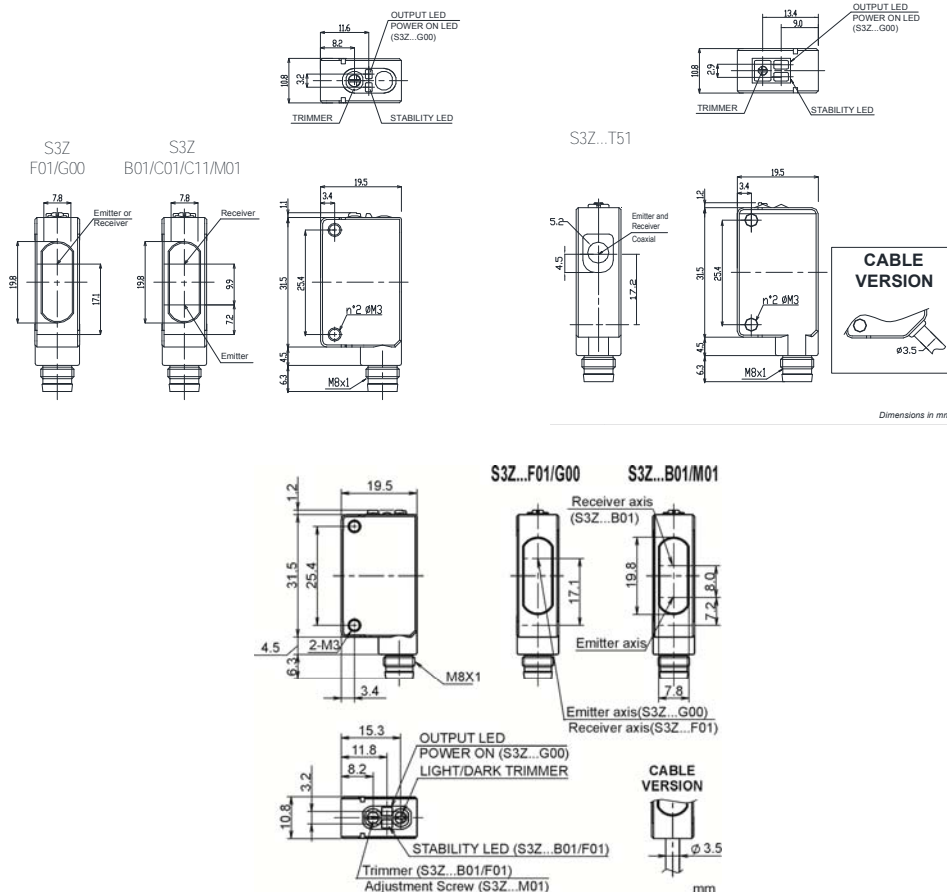

CONNECTIONS

CABLE

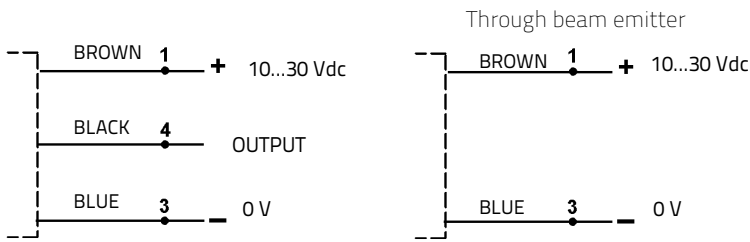

M8 CONNECTOR

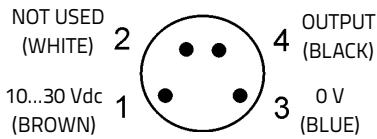

INDICATORS AND SETTINGS

S3Z...F01/G00/B01/C01/M01

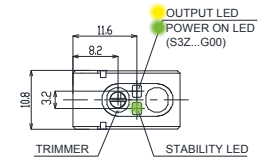

S3Z...T51

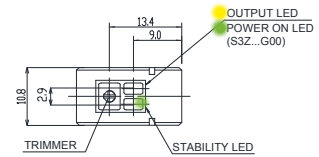

S3Z...F01/G00/B01/M01

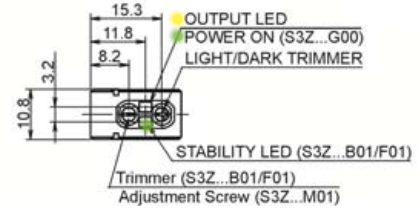
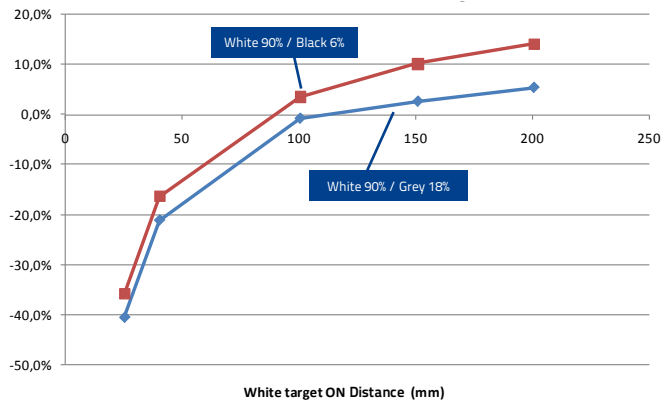
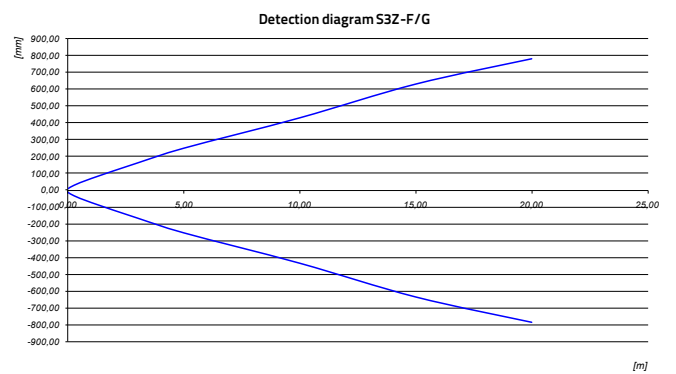

DIAGRAM LED MODELS

BACKGROUND SUPPRESSION - DISTANCE DIFFERENCE VS REFLECTANCE TARGET



THROUGH BEAM - DETECTION AREA



POLARIZED RETROREFLECTIVE - DETECTION AREA

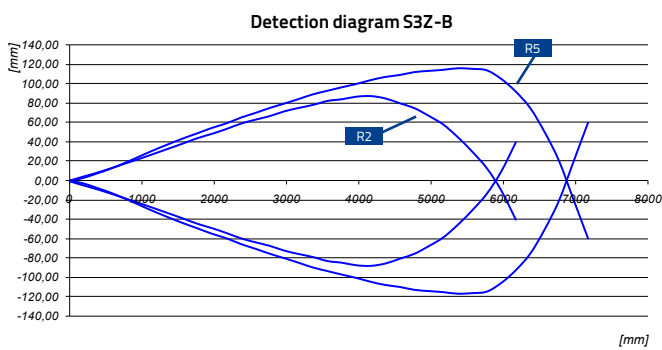

DIFFUSE PROXIMITY - DETECTION AREA

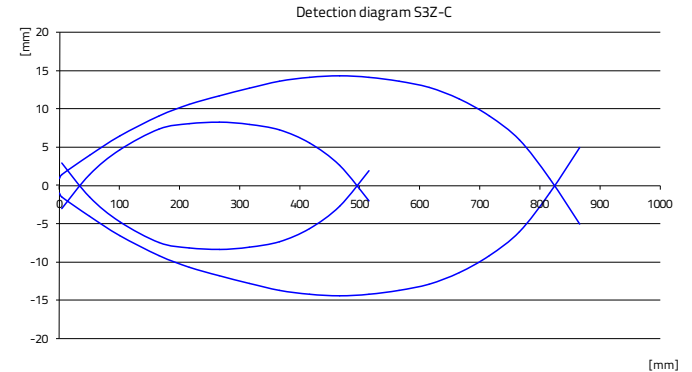

NARROW BEAM PROXIMITY - DETECTION AREA

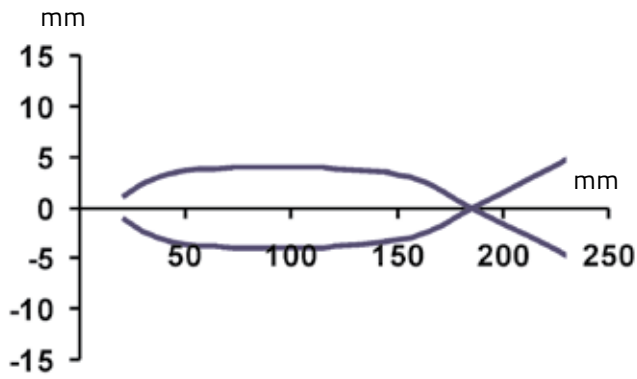

POLARIZED RETROREFLECTIVE FOR TRANSPARENT - DETECTION AREA

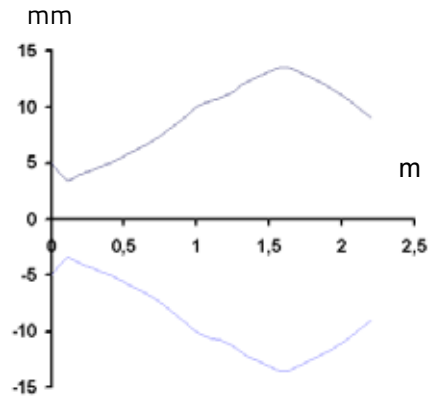

DIAGRAMS LASER MODELS

BACKGROUND SUPPRESSION - DETECTION AREA

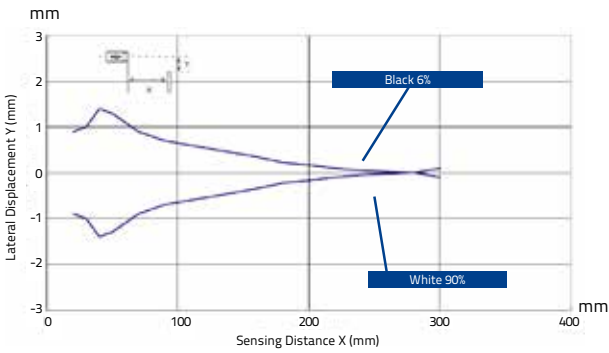

BACKGROUND SUPPRESSION - SPOT DIMENSION

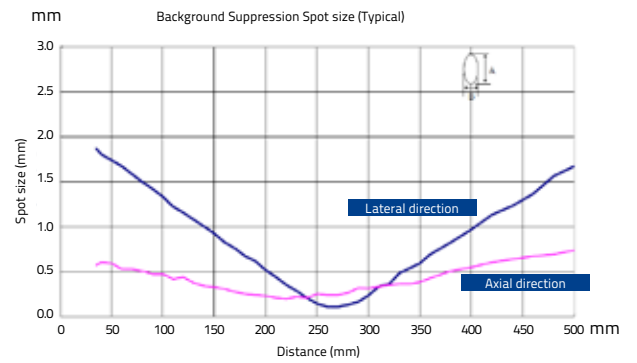

POLARIZED RETROREFLECTIVE - DETECTION AREA

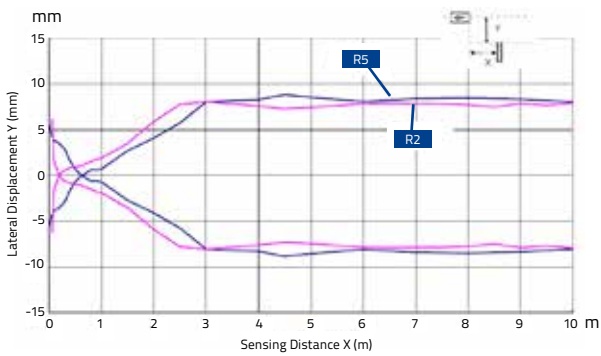

POLARIZED RETROREFLECTIVE - EXCESS GAIN

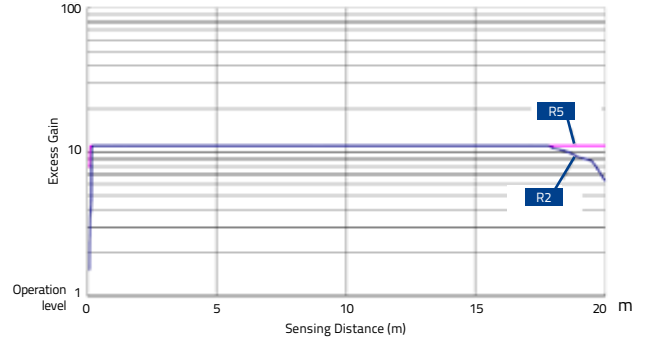

THROUGH BEAM - DETECTION AREA

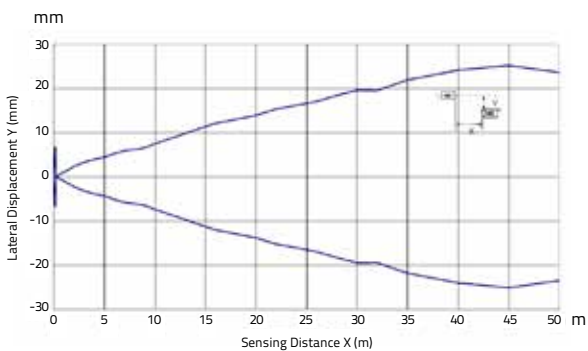

THROUGH BEAM - EXCESS GAIN

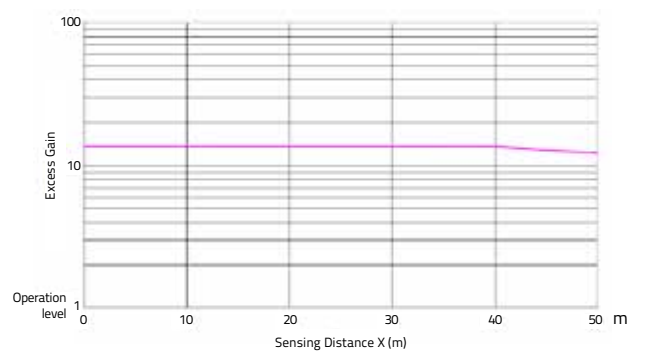

MODEL SELECTION AND ORDER INFORMATION

OPTIC FUNCTION	EMISSION	CONNECTION	OUTPUT	MODEL	ORDER No.
Narrow beam diffuse proximity	LED	2 m Cable	PNP - LIGHT	S3Z-PR-2-C01-PL	95B010040
		M8 Connector	PNP - LIGHT	S3Z-PR-5-C01-PL	95B010050
		2 m Cable	PNP - DARK	S3Z-PR-2-C01-PD	95B010060
		M8 Connector	PNP - DARK	S3Z-PR-5-C01-PD	95B010070
		2 m Cable	NPN - LIGHT	S3Z-PR-2-C01-NL	95B010200
		M8 Connector	NPN - LIGHT	S3Z-PR-5-C01-NL	95B010210
Long diffuse proximity	LED	2 m Cable	NPN - DARK	S3Z-PR-2-C01-ND	95B010220
		M8 Connector	NPN - DARK	S3Z-PR-5-C01-ND	95B010230
		2 m Cable	PNP - LIGHT	S3Z-PR-2-C11-PL	95B010001
		M8 Connector	PNP - LIGHT	S3Z-PR-5-C11-PL	95B010011
		2 m Cable	PNP - DARK	S3Z-PR-2-C11-PD	95B010021
		M8 Connector	PNP - DARK	S3Z-PR-5-C11-PD	95B010031
Polarized retroreflective	LED	2 m Cable	NPN - LIGHT	S3Z-PR-2-C11-NL	95B010161
		M8 Connector	NPN - LIGHT	S3Z-PR-5-C11-NL	95B010171
		2 m Cable	NPN - DARK	S3Z-PR-2-C11-ND	95B010181
		M8 Connector	NPN - DARK	S3Z-PR-5-C11-ND	95B010191
		2 m Cable	PNP - LIGHT	S3Z-PR-2-B01-PL	95B010081
		M8 Connector	PNP - LIGHT	S3Z-PR-5-B01-PL	95B010091
Through beam	LED	2 m Cable	PNP - DARK	S3Z-PR-2-B01-PD	95B010101
		M8 Connector	PNP - DARK	S3Z-PR-5-B01-PD	95B010111
		2 m Cable	NPN - LIGHT	S3Z-PR-2-B01-NL	95B010241
		M8 Connector	NPN - LIGHT	S3Z-PR-5-B01-NL	95B010251
		2 m Cable	NPN - DARK	S3Z-PR-2-B01-ND	95B010261
		M8 Connector	NPN - DARK	S3Z-PR-5-B01-ND	95B010271
Background suPpression	LASER	2 m Cable	PNP - DARK/LIGHT	S3Z-PH-2-B01-P	95B010440
		M8 Connector	PNP - DARK/LIGHT	S3Z-PH-5-B01-P	95B010460
		2 m Cable	NPN - DARK/LIGHT	S3Z-PH-2-B01-N	95B010450
		M8 Connector	NPN - DARK/LIGHT	S3Z-PH-5-B01-N	95B010470
		2 m Cable	PNP - LIGHT	S3Z-PR-2-FG01-PL	95B010121
		M8 Connector	PNP - LIGHT	S3Z-PR-5-FG01-PL	95B010131
Polarized retroreflective for transparent	LED	2 m Cable	PNP - DARK	S3Z-PR-2-FG01-PD	95B010141
		M8 Connector	PNP - DARK	S3Z-PR-5-FG01-PD	95B010151
		2 m Cable	NPN - LIGHT	S3Z-PR-2-FG01-NL	95B010281
		M8 Connector	NPN - LIGHT	S3Z-PR-5-FG01-NL	95B010291
		2 m Cable	NPN - DARK	S3Z-PR-2-FG01-ND	95B010301
		M8 Connector	NPN - DARK	S3Z-PR-5-FG01-ND	95B010311
Background suPpression	LASER	2 m Cable	PNP - DARK/LIGHT	S3Z-PH-2-FG01-P	95B010520
		M8 Connector	PNP - DARK/LIGHT	S3Z-PH-5-FG01-P	95B010540
		2 m Cable	NPN - DARK/LIGHT	S3Z-PH-2-FG01-N	95B010530
		M8 Connector	NPN - DARK/LIGHT	S3Z-PH-5-FG01-N	95B010550
		2 m Cable	PNP - LIGHT	S3Z-PR-2-M01-PL	95B010331
		M8 Connector	PNP - LIGHT	S3Z-PR-5-M01-PL	95B010351
Background suPpression	LED	2 m Cable	NPN - LIGHT	S3Z-PR-2-M01-NL	95B010321
		M8 Connector	NPN - LIGHT	S3Z-PR-5-M01-NL	95B010341
		2 m Cable	PNP - DARK/LIGHT	S3Z-PH-2-M01-P	95B010480
		M8 Connector	PNP - DARK/LIGHT	S3Z-PH-5-M01-P	95B010500
		2 m Cable	NPN - DARK/LIGHT	S3Z-PH-2-M01-N	95B010490
		M8 Connector	NPN - DARK/LIGHT	S3Z-PH-5-M01-N	95B010510
Polarized retroreflective for transparent	LED	2 m Cable	NPN - DARK	S3Z-PR-2-T51-ND	95B010390
		2 m Cable	PNP - DARK	S3Z-PR-2-T51-PD	95B010380
		M8 Connector	NPN - DARK	S3Z-PR-5-T51-ND	95B010370
		M8 Connector	PNP - DARK	S3Z-PR-5-T51-PD	95B010360

ACCESSORIES

ST-505

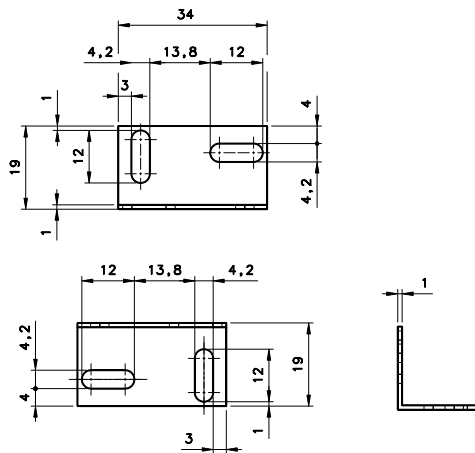

ST-5039

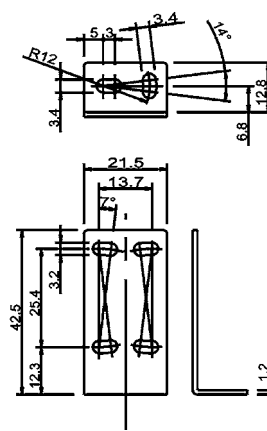

ST-5046

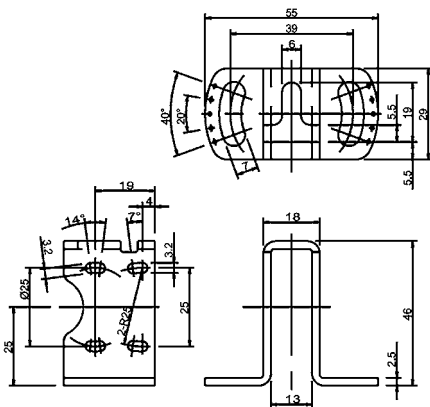

ST-5040

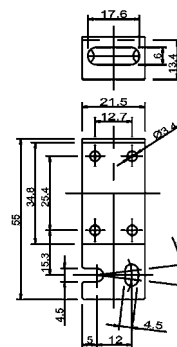

SLIT

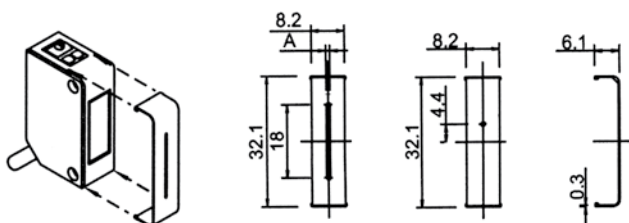

M18 ADAPTER NOSE



MODEL	DESCRIPTION	ORDER NO.
ST-505	lateral mounting	95ACC2800
ST-5039	L-shaped fixing bracket	95ACC2270
ST-5040	protection bracket with vertical fixing (only for cable versions)	95ACC2280
ST-5046	protection bracket with horizontal fixing	95ACC2370
S3Z-SLIT1	∅ 0,5 mm slit for through beam	95ACC2470
S3Z-SLIT2	∅ 1 mm slit for through beam	95ACC2480
S3Z-SLIT3	∅ 2 mm slit for through beam	95ACC2490
S3Z-SLIT4	0,5x18 mm slit for through beam	95ACC2500
S3Z-SLIT5	1x18 mm slit for through beam	95ACC2510
S3Z-SLIT6	2x18 mm slit for through beam	95ACC2520
ST-S3Z-M18	S3Z FIX BRK M18 THREADED NOSE	95ACC7850

CABLES

TYPE	DESCRIPTION	LENGTH	MODEL	ORDER No.
Axial M8 Connector	4-pole, grey, P.V.C.	3 m	CS-B1-02-G-03	95A251420
		5 m	CS-B1-02-G-05	95A251430
		7 m	CS-B1-02-G-07	95A251440
		10 m	CS-B1-02-G-10	95A251480
	4-pole, P.U.R.	2 m	CS-B1-02-R-02	95A251620
		5 m	CS-B1-02-R-05	95A251640
Radial M8 Connector	4-pole, grey, P.V.C.	3 m	CS-B2-02-G-03	95A251450
		5 m	CS-B2-02-G-05	95A251460
		7 m	CS-B2-02-G-07	95A251470
		10 m	CS-B2-02-G-10	95A251530
	4-pole, P.U.R.	2 m	CS-B2-02-R-02	95A251630
		5 m	CS-B2-02-R-05	95A251650

