



Short Form Catalogue

LS Series Limit Switches



LS Series Limit Switches Foot Switches

Contents

Panorama	2
Limit Switches - Plastic Casing and Metal Casing.....	12
Safety Limit Switches - Plastic Casing and Metal Casing	42
Limit Switches with Latch and Manual Reset - Plastic Casing and Metal Casing.....	56
Foot Switches with Cover and Mini Foot Switches.....	62

LS Series Prewired

30 mm width

Metal Casing IP67

Plastic Casing IP67 – Double insulation

LS2 ...

M = Metal casing
P = Plastic casing

0 = Cable output left / right
1 = Cable output bottom



Type	LS2..M11, LS2..P11	LS2..M12, LS2..P12	LS2..M13, LS2..P13	LS2..M14, LS2..P14
Actuator	Brass plain plunger	Steel roller plunger	Plastic roller plunger	Cross steel roller plunger
Action type				
CENELEC Conformity / Positive opening operation	-	-	-	-



LS2..M41, LS2..P41	LS2..M42, LS2..P42	LS2..M45, LS2..P45	LS2..M46, LS2..P46	LS2..M51, LS2..P51	LS2..M54, LS2..P54
ø14 plastic roller lever	ø14 steel roller lever	ø18 plastic roller with bent lever	ø18 steel roller with bent lever	Adjustable ø18 plastic roller lever	Adjustable ø18 steel roller lever
-	-	-	-	-	-

35 mm width

Metal Casing IP67

Plastic Casing IP67 – Double insulation

LS2 ...

M = Metal casing
P = Plastic casing





































5 = Cable output left / right
6 = Cable output bottom



As the range is very large, the products shown there are the most common. For the complete range, please consult us.

Type	LS2..M11, LS2..P11	LS2..M12, LS2..P12	LS2..M14, LS2..P14	LS2..M21, LS2..P21
Actuator	Brass plain plunger	Steel roller plunger	Cross steel roller plunger	Brass plain plunger with fixing nuts
Action type				
CENELEC conformity / Positive opening operation	-	-	-	-

Limit Switches - IP67

					
LS2..M15, LS2..P15	LS2..M21, LS2..P21	LS2..M22, LS2..P22	LS2..M23, LS2..P23	LS2..M24, LS2..P24	LS2..M25, LS2..P25
Cross plastic roller plunger	Brass plain plunger with fixing nuts	Steel roller plunger with fixing nuts	Plastic roller plunger with fixing nuts	Cross roller plunger with fixing nuts	Cross plastic roller plunger with fixing nuts
					
-	-	-	-	-	-
					
LS2..M71, LS2..P71	LS2..M72, LS2..P72	LS2..M73, LS2..P73	LS2..M78, LS2..P78	LS2..M91, LS2..P91	LS2..M92, LS2..P92
Adjustable $\varnothing 3$ steel rod lever	Adjustable $\varnothing 3$ fibre-glass rod lever	Adjustable $\varnothing 6$ polyamide rod lever	Adjustable $\varnothing 3$ steel rod lever	Spring rod	Flexible rod with insulated end
					
-	-	-	-	-	-
					
LS2..M22, LS2..P22	LS2..M24, LS2..P24	LS2..M41, LS2..P41	LS2..M51, LS2..P51	LS2..M71, LS2..P71	LS2..M91, LS2..P91
Steel roller plunger with fixing nuts	Cross steel roller lever with fixing nuts	$\varnothing 14$ Plastic roller lever	Adjustable $\varnothing 18$ plastic roller lever	Adjustable $\varnothing 3$ steel rod lever	Spring rod
					
-	-	-	-	-	-

LS Series Limit Switches

Plastic Casing IP65 - Double insulation

30 mm LS3 □ P...

60 mm LS7 □ P...

Width

Electrical Connection	0	= Pg 13.5
	1	= Pg 11
	3	= M16 x 1.5
	3	= M20 x 1.5
	5	= 1/2" NPT



Type	LS..P10, LS..P11	LS..P12, LS..P13	LS..P14	LS..P31
Actuator	Plain plunger	Roller plunger	Plain plunger	Roller lever
Action type				
CENELEC conformity / Positive opening operation	EN 50047	EN 50047	EN 50047	EN 50047

Nota: For LS7□P... (60 mm width) compatible with EN 50047 (fixing)



LS..P51, LS..P53	LS..P52	LS..P55	LS..P61	LS..P62	LS..P71, LS..P72
Adjustable roller lever	Adjustable roller lever	Adjustable roller lever	Flexible lever	Flexible lever	Adjustable rod lever
-	-	-	-	-	-

Plastic Casing IP65 - Double insulation

40 mm LS4 □ P...

Width

Electrical Connection	0	= Pg 13.5
	3	= M20 x 1.5
	5	= 1/2" NPT

As the range is very large, the products shown here are the most common. For the complete range, please consult us.

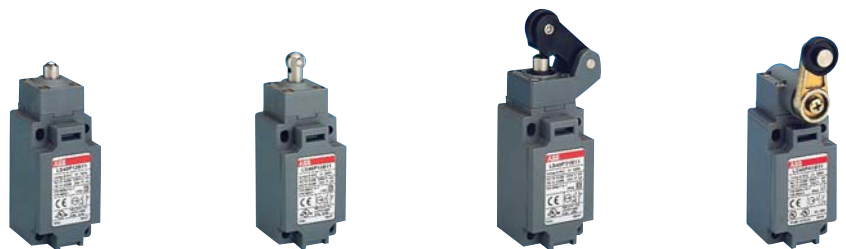

Type	LS..P11	LS..P13	LS..P31	LS..P41
Actuator	Plain plunger	Roller plunger	Roller lever	Roller lever
Action type				
CENELEC conformity / Positive opening operation	EN 50041	EN 50041	-	EN 50041

Plastic Casing IP65



LS..P32

Roller lever



LS..P35

Roller lever



EN 50047



LS..P38

Adjustable roller lever



LS..P41, LS..P43

Roller lever

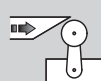

EN 50047



LS..P42

Roller lever

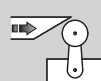

LS..P45, LS..P46

Roller lever

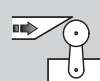

LS..P73

Adjustable rod lever



LS..P74

Adjustable rod lever



LS..P78

Adjustable rod lever



LS..P91

Flexible rod



LS..P92

Flexible rod



LS..P98B11-A

Pull action



LS..P44

Roller lever

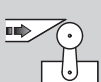

LS..P51

Adjustable roller levers

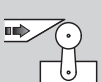

LS..P54

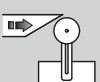

LS..P61

Adjustable flexible and rigid rod levers



LS..P72

Adjustable flexible and rigid rod levers



LS..P91

Flexible rod



EN 50041

LS Series Limit Switches

Metal Casing IP66

30 mm LS3 □ M...

60 mm LS7 □ M...

Width

Electrical Connection	0	= Pg 13.5
	1	= Pg 11
	3	= M16 x 1.5
	3	= M20 x 1.5
	5	= 1/2" NPT



Type	LS..M11	LS..M12, LS..M13	LS..M14	LS..M31
Actuator	Plain plunger	Roller plunger	Plain plunger	Roller lever
Action type				
CENELEC conformity / Positive opening operation	EN 50047	EN 50047	EN 50047	EN 50047

Nota: For LS7□M... (60 mm width) compatible with EN 50047 (fixing)



LS..M51, LS..M53	LS..M52	LS..M55	LS..M61	LS..M62	LS..M71, LS..M72
Adjustable roller lever	Adjustable roller lever	Adjustable roller lever	Flexible lever	Flexible lever	Adjustable rod lever
-	-	-	-	-	-

Metal Casing IP66

40 mm LS4 □ M...

Width

Electrical Connection	0	= Pg 13.5
	3	= M20 x 1.5
	5	= 1/2" NPT



As the range is very large, the products shown here are the most common. For the complete range, please consult us.

Type	LS..M11	LS..M13	LS..M21	LS..M22	LS..M31
Actuator	Plain plunger	Roller plunger	Plain plunger	Roller plunger	Roller lever
Action type					
CENELEC conformity / Positive opening operation	EN 50041	EN 50041	EN 50041	EN 50041	-

Metal Casing IP66



LS..M32

Roller lever



LS..M35

Roller lever



EN 50047

LS..M38

Adjustable roller lever



LS..M41, LS..M43

Roller lever



EN 50047

LS..M42

Roller lever



LS..M45, LS..M46

Roller lever



LS..M73

Adjustable rod lever



LS..M74

Adjustable rod lever



LS..M78

Adjustable rod lever



LS..M91

Flexible rod



LS..M92

Flexible rod



LS..M98B11-A

Pull action



LS..M41

Roller lever



EN 50041

LS..M51

Adjustable roller levers

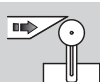

LS..M54

LS..M61

Adjustable flexible and rigid rod levers



LS..M72

Adjustable flexible and rigid rod levers



EN 50041

LS..M91

Flexible rod



LS Series Limit Switches

Safety Limit Switches

30 mm Width	LS 3	<div style="display: flex; align-items: center;"> <div style="border: 1px solid black; padding: 2px; margin-right: 5px;">P</div> = Plastic casing <div style="border: 1px solid black; padding: 2px; margin-right: 5px;">M</div> = Metal casing </div>	□ □ ...
			<div style="display: flex; align-items: center;"> <div style="border: 1px solid black; padding: 2px; margin-right: 5px;">0</div> = Pg 13.5 <div style="border: 1px solid black; padding: 2px; margin-right: 5px;">1</div> = Pg 11 <div style="border: 1px solid black; padding: 2px; margin-right: 5px;">2</div> = M16 x 1.5 <div style="border: 1px solid black; padding: 2px; margin-right: 5px;">3</div> = M20 x 1.5 <div style="border: 1px solid black; padding: 2px; margin-right: 5px;">5</div> = 1/2" NPT </div>
40 mm Width	LS 4	<div style="display: flex; align-items: center;"> <div style="border: 1px solid black; padding: 2px; margin-right: 5px;">P</div> = Plastic casing <div style="border: 1px solid black; padding: 2px; margin-right: 5px;">M</div> = Metal casing </div>	□ □ ...
			<div style="display: flex; align-items: center;"> <div style="border: 1px solid black; padding: 2px; margin-right: 5px;">0</div> = Pg 13.5 <div style="border: 1px solid black; padding: 2px; margin-right: 5px;">3</div> = M20 x 1.5 <div style="border: 1px solid black; padding: 2px; margin-right: 5px;">5</div> = 1/2" NPT </div>



Limit Switches	LS3..P80..-S	LS3..M80..-S	LS3..P81..-S	LS3..M81..-S	LS4..P80..-S	LS4..M80..-S
Operating head options:	Adjustable head		Pivoting head		Adjustable head	
Action type: Translation with small latch (key)						
Positive opening operation						

Keys

Keys							
Keys for LS3... limit switches	LSA30P03	LSA30P04	LSA30P05	LSA30P06	LSA30P07	LSA30P08	LSA30P09
Keys for LS4... limit switches			LSA40X05	LSA40X06	LSA40X07	LSA40X08	LSA40X09
Actuator	Right angle key	Straight key	Right angle key	Straight key	Right angle key + shock absorber	Straight key + shock absorber	Adjustable angle key
Fixing	22 mm	22 mm	13 mm	13 mm	15 mm	15 mm	40 mm

Limit Switches with Latch and Manual Reset

30 mm Width	LS 3	<div style="display: flex; align-items: center;"> <div style="border: 1px solid black; padding: 2px; margin-right: 5px;">P</div> = Plastic casing <div style="border: 1px solid black; padding: 2px; margin-right: 5px;">M</div> = Metal casing </div>	□ □ ...
			<div style="display: flex; align-items: center;"> <div style="border: 1px solid black; padding: 2px; margin-right: 5px;">0</div> = Pg 13.5 <div style="border: 1px solid black; padding: 2px; margin-right: 5px;">1</div> = Pg 11 <div style="border: 1px solid black; padding: 2px; margin-right: 5px;">2</div> = M16 x 1.5 <div style="border: 1px solid black; padding: 2px; margin-right: 5px;">3</div> = M20 x 1.5 <div style="border: 1px solid black; padding: 2px; margin-right: 5px;">5</div> = 1/2" NPT </div>



Limit Switches	LS3..P11..-R	LS3..M11..-R	LS3..P12..-R	LS3..M12..-R
Actuator:	Galvanized steel plain plunger		Galvanized steel roller plunger	
Action type				
Positive opening operation				

Plastic Casing IP65 and Metal Casing IP66

Safety Limit Switches with Pulling Cable

30 mm Width

LS 3 ...

40 mm Width

LS 4 ...

60 mm Width

LS 6 ...

Electrical Connection

0 = Pg 13.5
1 = Pg 11
2 = M16 x 1.5
3 = M20 x 1.5
5 = 1/2" NPT

P = Plastic casing
M = Metal casing

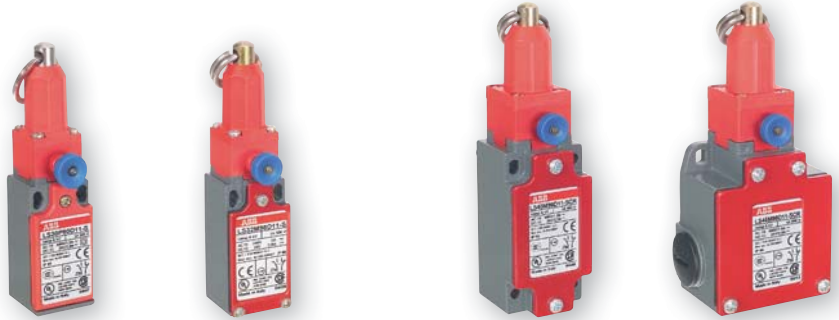

Limit Switches	LS3..P98..-SCR LS3..M98..-SCR	LS4..M98..-SCR LS6..M98..-SCR
Actuator:	By red cable	
Action type: Pulling		
Positive opening operation		

Safety Limit Switches with Rotative Axis or with Lever

30 mm Width

LS 3 ...

Electrical Connection

0 = Pg 13.5
1 = Pg 11
2 = M16 x 1.5
3 = M20 x 1.5
5 = 1/2" NPT

P = Plastic casing
M = Metal casing



Limit Switches	LS3..P75..-S LS3..M75..-S	LS3..P76..-S LS3..M76..-S	LS3..P77..-S LS3..M77..-S
Actuator:	Galvanized steel rotative axis	Stainless steel rotative axis	Galvanized steel lever
Action type			
Positive opening operation			

LS3..P13..-R	LS3..M13..-R	LS3..P31..-R	LS3..M31..-R	LS3..P32..-R	LS3..M32..-R	LS3..P41..-R	LS3..M41..-R
Plastic roller plunger		Plastic roller lever on galvanized steel plunger				Rotary lever with plastic roller	

Foot Switches with Cover

Double insulation IP65

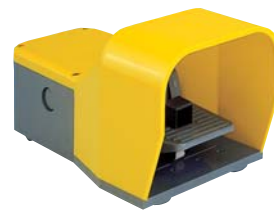
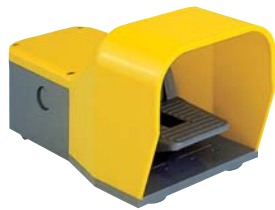

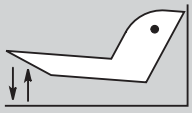
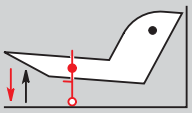
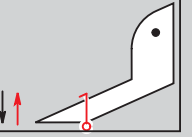
Foot Switches	IPS..1..	IPS..2..	IPS..3..
Actuator:	Free movement	Locked in neutral position	Latched in low position
Action type			
CENELEC conformity / Positive opening operation	-	-	-

Mini Foot Switches

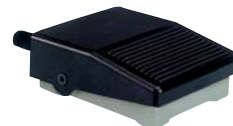

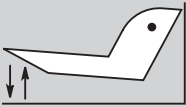
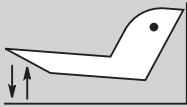
Mini Foot Switches	IPM..1..	IPM..2..
Actuator:	Free movement	Free movement
Action type		
CENELEC conformity / Positive opening operation	-	-



LS Series Limit Switches Foot Switches

Contents

Limit Switches

Description	12
Ordering Details.....	15
Travel and Operation Diagrams.....	23
Technical Data	24
Selection Table and Functional Characteristics	26

Safety Limit Switches

Description	42
Ordering Details.....	45
Travel and Operation Diagrams.....	48
Technical Data	50
Selection Table and Functional Characteristics	51

Limit Switches with latch and manual reset

Description	56
Ordering Details.....	57
Travel and Operation Diagrams.....	58
Technical Data	59
Selection Table and Functional Characteristics	60

Foot Switches

Description	62
Ordering Details.....	63
Technical Data	64

LS20P ... LS26P.. and LS20M ... LS26M.. Prewired Limit Switches

Double Insulation - Plastic Casing IP67 or Metal Casing IP67

Applications

Easy to use, electromechanical limit switches offer specific qualities:

- Visible operation.
- Able to switch strong currents (5 A conventional thermal current).
- Electrically separated contacts (Zb shape).
- Contact blocks with positive opening operation of the "N.C." normally closed contact(s) (symbol ⊖).
- Precise operating points (consistency).
- Immune to electromagnetic disturbances.

They are exceptional detection devices thanks to these characteristics:

- Presence/absence.
- Positioning and travel limit.
- Objects passing/counting.

Description

LS20P ... LS26P limit switches, made of fibre-glass reinforced UL-V0 thermoplastic material, sealed with epoxy resin at the base on the body, offer double insulation and a degree of protection IP67.

LS20M ... LS26M limit switches, made of zinc alloy (zamack), sealed with epoxy resin at the base on the body, offer a degree of protection IP67.

The casings come in 2 dimensions: **LS20 ... LS21**, 30 mm width, **LS25 ... LS26**, 35 mm width.

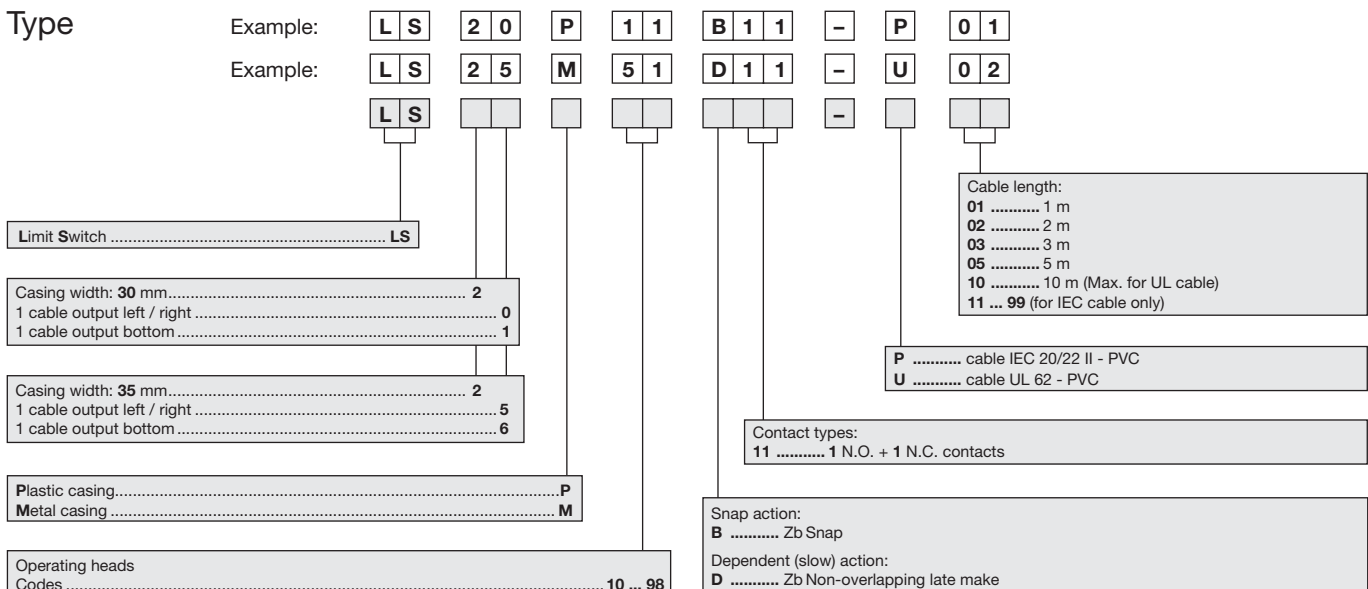
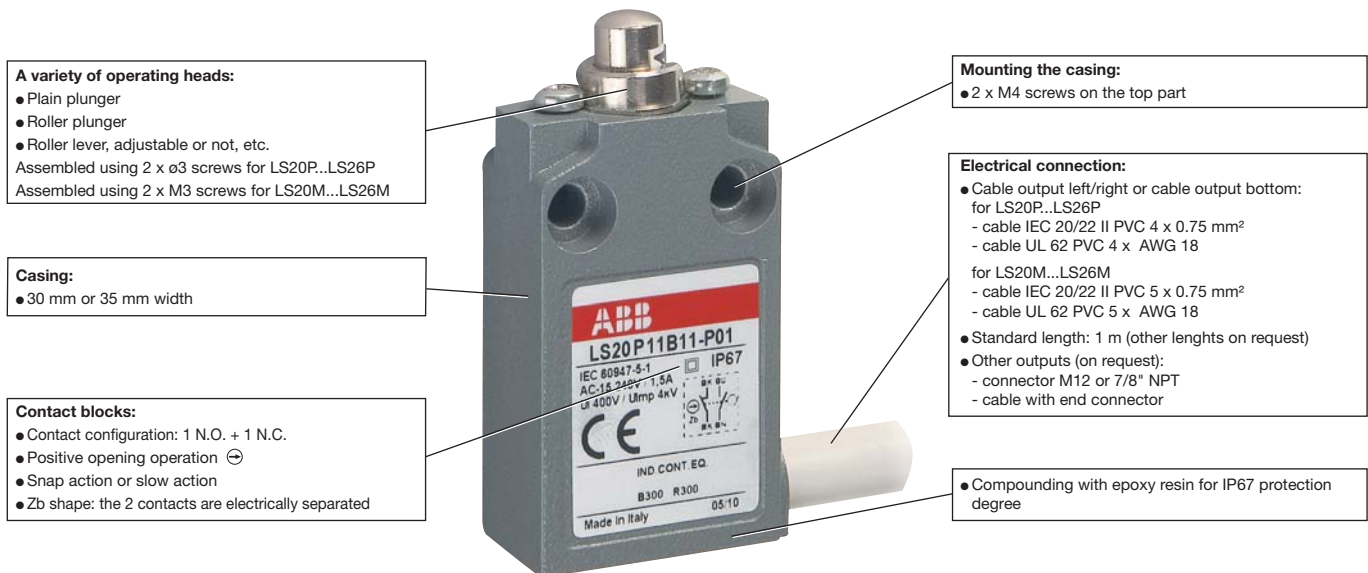

LS3..M., LS4..M.. and LS7..M.. Limit Switches

Metal Casing IP66

Applications

Easy to use, electromechanical limit switches offer specific qualities:

- Visible operation.
- Able to switch strong currents (10 A conventional thermal current).
- Electrically separated contacts.
- Contact blocks with positive opening operation of the "N.C." normally closed contact(s) (symbol ⊖).
- Precise operating points (consistency).
- Immune to electromagnetic disturbances.

They are exceptional detection devices thanks to these characteristics:

- Presence/absence.
- Positioning and travel limit.
- Objects passing/counting.

Description

Limit switches, **LS3..M..** and **LS7..M..**, which are made of zinc alloy (zamack), have a degree of protection IP66.

Limit switches, **LS4..M..**, which are made of aluminium alloy, have a degree of protection IP66.

The casings come in 3 dimensions: **LS3..M...** 30 mm width, **LS4..M...** 40 mm width, **LS7..M...** 60 mm width.

Cover:

- Closed using 3 x M3 screws for 30 mm width
- Closed using 4 x M3 screws for 60 mm width
- Closed using 2 x M4 screws for 40 mm width

One piece sealing gasket to ensure tightness

Mounting the casing:

- 2 x M4 screws for 30 mm width
- 2 or 4 x M5 screws for 40 mm width
- 2 or 4 x M4 screws for 60 mm width

Terminal for protective conductor placed near the cable inlet and marked: ⊕

- M3.5 (+,-) pozidriv 2 screw (Screw head with captive cable clamp)

Electrical connection:

- 1 (LS30M), 1 (LS40M) or 3 (LS70M) cable inlets for Pg 13.5 cable gland
- 1 (LS31M) or 3 (LS71M) cable inlets for Pg 11 cable gland
- 1 (LS32M) or 3 (LS72M) cable inlets for ISO 16 cable gland
- 1 (LS33M), 1 (LS43M) or 3 (LS73M) cable inlets for ISO 20 cable gland
- 1 (LS35M), 1 (LS45M) or 3 (LS75M) cable inlets for 1/2 NPT cable gland
- Suitable for conduit connection only with use of adaptor sleeve optionally provided by manufacturer. (on request)

A variety of operating heads:

- Plain plunger
- Roller plunger
- Roller lever, adjustable or not, etc.

Assembled using 4 x M3 screws for 30 & 60 mm width
Assembled using 4 x M4 screws for 40 mm width

Casing:

- 30 mm width with standardized dimensions according to EN 50047.
- 40 mm width with standardized dimensions according to EN 50041.
- 60 mm width compatible with EN 50047 (Fixing).

Block of 2 contacts:

- Contact configuration: 1 N.O. + 1 N.C. or 2 N.O. or 2 N.C.
- Positive opening operation ⊖
- Snap action or slow action
- The 2 contacts are electrically separated

Connecting terminals:

- M3.5 (+,-) pozidriv 2 screw (Screw head with captive cable clamp)
- Markings conform with IEC 60947-1, IEC 60947-5-1, EN 50005 and EN 50013 standards

Type Example: **L S 3 2 M 4 1 B 1 1**

Limit Switch.....	LS
Casing width: 30 mm.....	3
1 cable inlet for Pg 13.5 cable gland.....	0
1 cable inlet for Pg 11 cable gland.....	1
1 cable inlet M16 x 1.5 for ISO 16 cable gland.....	2
1 cable inlet M20 x 1.5 for ISO 20 cable gland.....	3
1 cable inlet for 1/2" NPT cable gland.....	5
Casing width: 40 mm.....	4
1 cable inlet for Pg 13.5 cable gland.....	0
1 cable inlet M20 x 1.5 for ISO 20 cable gland.....	3
1 cable inlet for 1/2" NPT cable gland.....	5
Casing width: 60 mm (new casing).....	7
3 cable inlets for Pg 13.5 cable gland.....	0
3 cable inlets for Pg 11 cable gland.....	1
3 cable inlets M16 x 1.5 for ISO 16 cable gland.....	2
3 cable inlets M20 x 1.5 for ISO 20 cable gland.....	3
3 cable inlets for 1/2" NPT cable gland.....	5

Contact types:

11 1 N.O. + 1 N.C. contacts
20 2 N.O. contacts
02 2 N.C. contacts

Snap action:
B Zb Snap (except for 2 N.O. contacts)

Dependent (slow) action:
L Slow / Simultaneous
D Zb Non-overlapping late make
C Zb Overlapping early make

Operating heads: (see panorama)
10 ... 98 Codes

M Metal casing

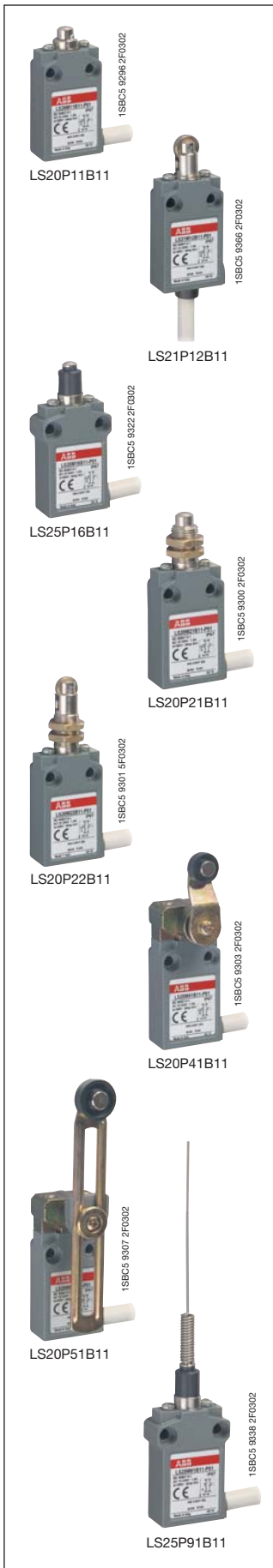

LS2..P.. Limit Switches

Double insulation  - Plastic Casing IP67
30 mm and 35 mm Width



LS20P: 1 cable output left / right	0	5	9	Plastic Casing - IP67 30 mm Width
LS21P: 1 cable output bottom	1	6	0	
LS25P: 1 cable output left / right	5	6	7	Plastic Casing - IP67 35 mm Width
LS26P: 1 cable output bottom	6	6	8	

Ordering Details

Contact blocks	Type	Order code	Weight kg (1)(2)	Pack ^{ing} 1 piece
 B11	 D11	see table below state cable output code □ □	see table below state cable output code □ □	

Brass plain plunger (nickel plated)

1	-	LS2 □ P11B11-P □ □	1SBV01 □ □ 11R32 □ □	0.125
1	-	LS2 □ P11B11-U □ □	1SBV01 □ □ 11R38 □ □	0.125
-	1	LS2 □ P11D11-P □ □	1SBV01 □ □ 11R33 □ □	0.125
-	1	LS2 □ P11D11-U □ □	1SBV01 □ □ 11R39 □ □	0.125

Steel roller plunger (zinc plated)

1	-	LS2 □ P12B11-P □ □	1SBV01 □ □ 12R32 □ □	0.130
1	-	LS2 □ P12B11-U □ □	1SBV01 □ □ 12R38 □ □	0.130
-	1	LS2 □ P12D11-P □ □	1SBV01 □ □ 12R33 □ □	0.130
-	1	LS2 □ P12D11-U □ □	1SBV01 □ □ 12R39 □ □	0.130

Brass plain plunger (nickel plated) with dust protection

1	-	LS2 □ P16B11-P □ □	1SBV01 □ □ 16R32 □ □	0.125
1	-	LS2 □ P16B11-U □ □	1SBV01 □ □ 16R38 □ □	0.125
-	1	LS2 □ P16D11-P □ □	1SBV01 □ □ 16R33 □ □	0.125
-	1	LS2 □ P16D11-U □ □	1SBV01 □ □ 16R39 □ □	0.125

Brass plain plunger (zinc plated) with fixing nuts

1	-	LS2 □ P21B11-P □ □	1SBV01 □ □ 21R32 □ □	0.140
1	-	LS2 □ P21B11-U □ □	1SBV01 □ □ 21R38 □ □	0.140
-	1	LS2 □ P21D11-P □ □	1SBV01 □ □ 21R33 □ □	0.140
-	1	LS2 □ P21D11-U □ □	1SBV01 □ □ 21R39 □ □	0.140

Steel roller plunger (zinc plated) with fixing nuts

1	-	LS2 □ P22B11-P □ □	1SBV01 □ □ 22R32 □ □	0.145
1	-	LS2 □ P22B11-U □ □	1SBV01 □ □ 22R38 □ □	0.145
-	1	LS2 □ P22D11-P □ □	1SBV01 □ □ 22R33 □ □	0.145
-	1	LS2 □ P22D11-U □ □	1SBV01 □ □ 22R39 □ □	0.145

ø14 plastic (polyacetal) roller lever

1	-	LS2 □ P41B11-P □ □	1SBV01 □ □ 41R32 □ □	0.175
1	-	LS2 □ P41B11-U □ □	1SBV01 □ □ 41R38 □ □	0.175
-	1	LS2 □ P41D11-P □ □	1SBV01 □ □ 41R33 □ □	0.175
-	1	LS2 □ P41D11-U □ □	1SBV01 □ □ 41R39 □ □	0.175

Adjustable ø18 plastic (polyacetal) roller lever

1	-	LS2 □ P51B11-P □ □	1SBV01 □ □ 51R32 □ □	0.190
1	-	LS2 □ P51B11-U □ □	1SBV01 □ □ 51R38 □ □	0.190
-	1	LS2 □ P51D11-P □ □	1SBV01 □ □ 51R33 □ □	0.190
-	1	LS2 □ P51D11-U □ □	1SBV01 □ □ 51R39 □ □	0.190

Spring rod

1	-	LS2 □ P91B11-P □ □	1SBV01 □ □ 91R32 □ □	0.190
1	-	LS2 □ P91B11-U □ □	1SBV01 □ □ 91R38 □ □	0.190

(1) With LS25 & LS26 add extra 0.005 kg - (2) With 1 m of cable (add 0.07 kg by extra meter length)

Length cable code (Other length on request)

Cable length	Code	Code
1 m	0 1	0 1
2 m	0 2	0 2
5 m	0 5	0 5
10 m	1 0	1 0

Note: -P □ □ = cable IEC 20/22 II PVC, -U □ □ = cable UL 62 PVC maxi. 10 m

LS3..P.. Limit Switches

Double Insulation - Plastic Casing IP65 - 30 mm Width

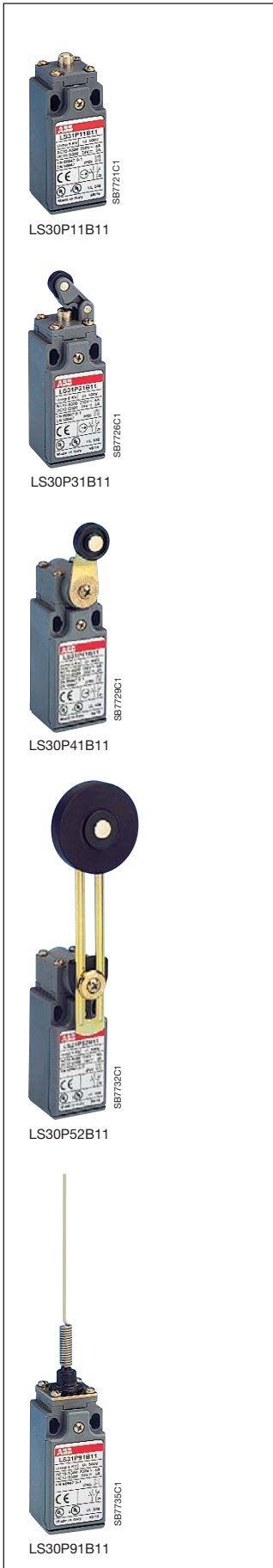

LS30P: 1 cable inlet for Pg 13.5 cable gland
 LS31P: 1 cable inlet for Pg 11 cable gland
 LS32P: 1 cable inlet for ISO 16 cable gland.....
 LS33P: 1 cable inlet for ISO 20 cable gland.....
 LS35P: 1 cable inlet by 1/2" NPT plastic adaptor

Ordering Details

Contact blocks	Type	Order code	Weight kg (1)
 B11	 D11	state cable inlet code <input type="checkbox"/> <input type="checkbox"/>	Pack ⁽¹⁾ 1 piece

Steel plain plunger (zinc plated)

1	-	LS3 <input type="checkbox"/> P11B11	1SBV01 <input type="checkbox"/> <input type="checkbox"/> 11R1211	0.070
-	1	LS3 <input type="checkbox"/> P11D11	1SBV01 <input type="checkbox"/> <input type="checkbox"/> 11R1411	0.070

ø11 plastic (polyacetal) roller plunger

1	-	LS3 <input type="checkbox"/> P13B11	1SBV01 <input type="checkbox"/> <input type="checkbox"/> 13R1211	0.070
-	1	LS3 <input type="checkbox"/> P13D11	1SBV01 <input type="checkbox"/> <input type="checkbox"/> 13R1411	0.070

ø12.5 plastic (polyacetal) roller lever on steel plunger (zinc plated) horizontal action

1	-	LS3 <input type="checkbox"/> P31B11	1SBV01 <input type="checkbox"/> <input type="checkbox"/> 31R1211	0.070
-	1	LS3 <input type="checkbox"/> P31D11	1SBV01 <input type="checkbox"/> <input type="checkbox"/> 31R1411	0.070

ø12.5 plastic (polyacetal) roller lever on steel plunger (zinc plated) vertical action

1	-	LS3 <input type="checkbox"/> P32B11	1SBV01 <input type="checkbox"/> <input type="checkbox"/> 32R1211	0.075
-	1	LS3 <input type="checkbox"/> P32D11	1SBV01 <input type="checkbox"/> <input type="checkbox"/> 32R1411	0.075

ø18 plastic (polyacetal) roller lever

1	-	LS3 <input type="checkbox"/> P41B11	1SBV01 <input type="checkbox"/> <input type="checkbox"/> 41R1211	0.090
-	1	LS3 <input type="checkbox"/> P41D11	1SBV01 <input type="checkbox"/> <input type="checkbox"/> 41R1411	0.090

ø50 rubber roller lever

1	-	LS3 <input type="checkbox"/> P42B11	1SBV01 <input type="checkbox"/> <input type="checkbox"/> 42R1211	0.120
-	1	LS3 <input type="checkbox"/> P42D11	1SBV01 <input type="checkbox"/> <input type="checkbox"/> 42R1411	0.120

Adjustable ø18 plastic (polyacetal) roller lever

1	-	LS3 <input type="checkbox"/> P51B11	1SBV01 <input type="checkbox"/> <input type="checkbox"/> 51R1211	0.100
-	1	LS3 <input type="checkbox"/> P51D11	1SBV01 <input type="checkbox"/> <input type="checkbox"/> 51R1411	0.100

Adjustable ø50 rubber roller lever

1	-	LS3 <input type="checkbox"/> P52B11	1SBV01 <input type="checkbox"/> <input type="checkbox"/> 52R1211	0.130
-	1	LS3 <input type="checkbox"/> P52D11	1SBV01 <input type="checkbox"/> <input type="checkbox"/> 52R1411	0.130

Adjustable ø3 fibre-glass rod lever

1	-	LS3 <input type="checkbox"/> P72B11	1SBV01 <input type="checkbox"/> <input type="checkbox"/> 72R1211	0.100
-	1	LS3 <input type="checkbox"/> P72D11	1SBV01 <input type="checkbox"/> <input type="checkbox"/> 72R1411	0.100

Spring rod

1	-	LS3 <input type="checkbox"/> P91B11	1SBV01 <input type="checkbox"/> <input type="checkbox"/> 91R1211	0.080
-	1	LS3 <input type="checkbox"/> P91D11	1SBV01 <input type="checkbox"/> <input type="checkbox"/> 91R1411	0.080

(1) For LS35P add 0.007 kg

LS7..P.. Limit Switches

Double Insulation - Plastic Casing IP65 - 60 mm Width



LS72P11B11

1SBC5 8586 5F0302



LS72P31B11

1SBC5 8589 4F0302



LS72P41B11

1SBC5 8602 4F0302



LS72P91B11

1SBC5 8600 5F0302



LS72P98B11-A

1SBC5 8602 4F0302

LS70P: 2 cable inlets for Pg 13.5 cable gland0..... 09
 LS71P: 2 cable inlets for Pg 11 cable gland1..... 08
 LS72P: 2 cable inlets for ISO 16 cable gland2..... 10
 LS73P: 2 cable inlets for ISO 20 cable gland3..... 28
 LS75P: 1 cable inlet by 1/2" NPT plastic adaptor + 1 cable inlet Pg 11
 for additional 1/2" NPT plastic adaptor.....5..... 27

Ordering Details

Contact blocks	Type	Order code	Weight kg (1)
B11	D11	state cable inlet code <input type="checkbox"/>	Pack ^{ing} 1 piece

Steel plain plunger (zinc plated)

1	-	LS7 <input type="checkbox"/> P11B11	1SBV01 <input type="checkbox"/> <input type="checkbox"/> 11R1211	0.100
-	1	LS7 <input type="checkbox"/> P11D11	1SBV01 <input type="checkbox"/> <input type="checkbox"/> 11R1411	0.100

ø11 plastic (polyacetal) roller plunger

1	-	LS7 <input type="checkbox"/> P13B11	1SBV01 <input type="checkbox"/> <input type="checkbox"/> 13R1211	0.100
-	1	LS7 <input type="checkbox"/> P13D11	1SBV01 <input type="checkbox"/> <input type="checkbox"/> 13R1411	0.100

ø12.5 plastic (polyacetal) roller lever on steel plunger (zinc plated)

1	-	LS7 <input type="checkbox"/> P31B11	1SBV01 <input type="checkbox"/> <input type="checkbox"/> 31R1211	0.105
-	1	LS7 <input type="checkbox"/> P31D11	1SBV01 <input type="checkbox"/> <input type="checkbox"/> 31R1411	0.105

ø18 plastic (polyacetal) roller lever

1	-	LS7 <input type="checkbox"/> P41B11	1SBV01 <input type="checkbox"/> <input type="checkbox"/> 41R1211	0.125
-	1	LS7 <input type="checkbox"/> P41D11	1SBV01 <input type="checkbox"/> <input type="checkbox"/> 41R1411	0.125

ø50 rubber roller lever

1	-	LS7 <input type="checkbox"/> P42B11	1SBV01 <input type="checkbox"/> <input type="checkbox"/> 42R1211	0.145
-	1	LS7 <input type="checkbox"/> P42D11	1SBV01 <input type="checkbox"/> <input type="checkbox"/> 42R1411	0.145

Adjustable ø18 plastic (polyacetal) roller lever

1	-	LS7 <input type="checkbox"/> P51B11	1SBV01 <input type="checkbox"/> <input type="checkbox"/> 51R1211	0.135
-	1	LS7 <input type="checkbox"/> P51D11	1SBV01 <input type="checkbox"/> <input type="checkbox"/> 51R1411	0.135

Adjustable ø50 rubber roller lever

1	-	LS7 <input type="checkbox"/> P52B11	1SBV01 <input type="checkbox"/> <input type="checkbox"/> 52R1211	0.155
-	1	LS7 <input type="checkbox"/> P52D11	1SBV01 <input type="checkbox"/> <input type="checkbox"/> 52R1411	0.155

Adjustable ø3 fibre-glass rod lever

1	-	LS7 <input type="checkbox"/> P72B11	1SBV01 <input type="checkbox"/> <input type="checkbox"/> 72R1211	0.120
-	1	LS7 <input type="checkbox"/> P72D11	1SBV01 <input type="checkbox"/> <input type="checkbox"/> 72R1411	0.120

Spring rod

1	-	LS7 <input type="checkbox"/> P91B11	1SBV01 <input type="checkbox"/> <input type="checkbox"/> 91R1211	0.110
-	1	LS3 <input type="checkbox"/> P91D11	1SBV01 <input type="checkbox"/> <input type="checkbox"/> 91R1411	0.110

Pull action with ring

1	-	LS7 <input type="checkbox"/> P98B11-A	1SBV01 <input type="checkbox"/> <input type="checkbox"/> 98R1211	0.145
-	1	LS7 <input type="checkbox"/> P98D11-A	1SBV01 <input type="checkbox"/> <input type="checkbox"/> 98R1411	0.145

(1) For LS75P add 0.007 kg

LS2..M.. Limit Switches

Metal Casing IP67 - 30 mm and 35 mm Width

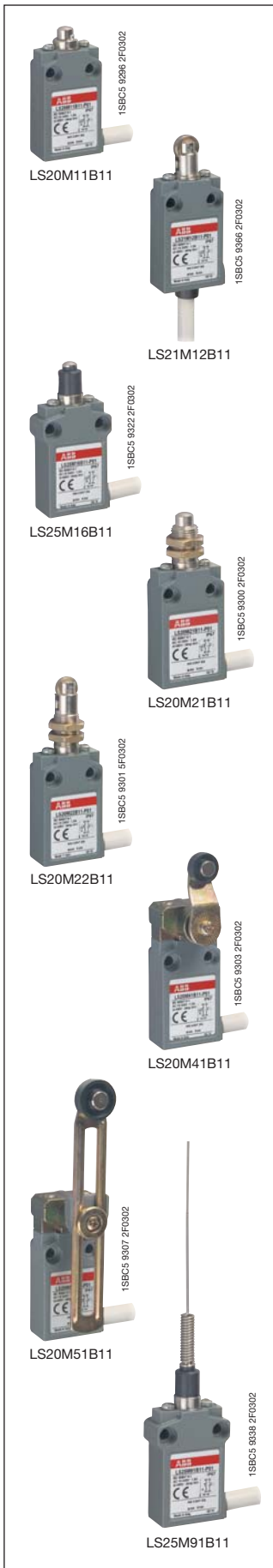

LS20M: 1 cable output left / right	0	5	5
LS21M: 1 cable output bottom	1	5	6
LS25M: 1 cable output left / right	5	6	3
LS26M: 1 cable output bottom	6	6	4

Metal Casing - IP67
30 mm Width
 Metal Casing - IP67
35 mm Width

Ordering Details

Contact blocks	Type	Order code	Weight kg (1)(2)
 B11	state cable output code	state cable output code	Pack ^{ing} 1 piece
 D11			

Brass plain plunger (nickel plated)

1	-	LS2 □ M11B11-P □ □	1SBV01 □ □ 11R20 □ □	0.175
1	-	LS2 □ M11B11-U □ □	1SBV01 □ □ 11R26 □ □	0.175
-	1	LS2 □ M11D11-P □ □	1SBV01 □ □ 11R21 □ □	0.175
-	1	LS2 □ M11D11-U □ □	1SBV01 □ □ 11R27 □ □	0.175

Steel roller plunger (zinc plated)

1	-	LS2 □ M12B11-P □ □	1SBV01 □ □ 12R20 □ □	0.180
1	-	LS2 □ M12B11-U □ □	1SBV01 □ □ 12R26 □ □	0.180
-	1	LS2 □ M12D11-P □ □	1SBV01 □ □ 12R21 □ □	0.180
-	1	LS2 □ M12D11-U □ □	1SBV01 □ □ 12R27 □ □	0.180

Brass plain plunger (nickel plated) with dust protection

1	-	LS2 □ M16B11-P □ □	1SBV01 □ □ 16R20 □ □	0.175
1	-	LS2 □ M16B11-U □ □	1SBV01 □ □ 16R26 □ □	0.175
-	1	LS2 □ M16D11-P □ □	1SBV01 □ □ 16R21 □ □	0.175
-	1	LS2 □ M16D11-U □ □	1SBV01 □ □ 16R27 □ □	0.175

Brass plain plunger (nickel plated) with fixing nuts

1	-	LS2 □ M21B11-P □ □	1SBV01 □ □ 21R20 □ □	0.190
1	-	LS2 □ M21B11-U □ □	1SBV01 □ □ 21R26 □ □	0.190
-	1	LS2 □ M21D11-P □ □	1SBV01 □ □ 21R21 □ □	0.190
-	1	LS2 □ M21D11-U □ □	1SBV01 □ □ 21R27 □ □	0.190

Steel roller plunger (zinc plated) with fixing nuts

1	-	LS2 □ M22B11-P □ □	1SBV01 □ □ 22R20 □ □	0.195
1	-	LS2 □ M22B11-U □ □	1SBV01 □ □ 22R26 □ □	0.195
-	1	LS2 □ M22D11-P □ □	1SBV01 □ □ 22R21 □ □	0.195
-	1	LS2 □ M22D11-U □ □	1SBV01 □ □ 22R27 □ □	0.195

ø14 plastic (polyacetal) roller lever

1	-	LS2 □ M41B11-P □ □	1SBV01 □ □ 41R20 □ □	0.225
1	-	LS2 □ M41B11-U □ □	1SBV01 □ □ 41R26 □ □	0.225
-	1	LS2 □ M41D11-P □ □	1SBV01 □ □ 41R21 □ □	0.225
-	1	LS2 □ M41D11-U □ □	1SBV01 □ □ 41R27 □ □	0.225

Adjustable ø18 plastic (polyacetal) roller lever

1	-	LS2 □ M51B11-P □ □	1SBV01 □ □ 51R20 □ □	0.240
1	-	LS2 □ M51B11-U □ □	1SBV01 □ □ 51R26 □ □	0.240
-	1	LS2 □ M51D11-P □ □	1SBV01 □ □ 51R21 □ □	0.240
-	1	LS2 □ M51D11-U □ □	1SBV01 □ □ 51R27 □ □	0.240

Spring rod

1	-	LS2 □ M91B11-P □ □	1SBV01 □ □ 91R20 □ □	0.240
1	-	LS2 □ M91B11-U □ □	1SBV01 □ □ 91R26 □ □	0.240

(1) For LS25 & LS26 add extra 0.005 kg - (2) With 1 m of cable (add 0.1 kg by extra meter length)

Length cable code		(Other length on request)	
Cable length	Code	Code	Code
1 m	0 1	0 1	0 1
2 m	0 2	0 2	0 2
5 m	0 5	0 5	0 5
10 m	1 0	1 0	1 0

Note: -P □ □ = cable IEC 20/22 II PVC, -U □ □ = cable UL 62 PVC maxi. 10 m

LS3..M.. Limit Switches

Metal Casing IP66 - 30 mm Width



LS32M11B11

1SBC5 8567 3F0302



LS32M12B11

1SBC5 8569 3F0302



LS32M38B11

1SBC5 8572 3F0302



LS32M41B11

1SBC5 8573 3F0302



LS32M51B11

1SBC5 8576 3F0302

LS30M: 1 cable inlet for Pg 13.5 cable gland 0 1 8
 LS31M: 1 cable inlet for Pg 11 cable gland 1 1 7
 LS32M: 1 cable inlet for ISO 16 cable gland 2 1 9
 LS33M: 1 cable inlet for ISO 20 cable gland 3 3 8
 LS35M: 1 cable inlet for 1/2" NPT cable gland 5 3 7

Ordering Details

Contact blocks	Type	Order code	Weight kg
 B11	 D11	state cable inlet code □ □	Pack ^{ing} 1 piece

Steel plain plunger (zinc plated)

1	-	LS3 □ M11B11	1SBV01 □ □ 11R1211	0.180
-	1	LS3 □ M11D11	1SBV01 □ □ 11R1411	0.180

Steel roller plunger (zinc plated)

1	-	LS3 □ M12B11	1SBV01 □ □ 12R1211	0.185
-	1	LS3 □ M12D11	1SBV01 □ □ 12R1411	0.185

ø12.5 plastic (polyacetal) roller lever on steel plunger (zinc plated) horizontal action

1	-	LS3 □ M31B11	1SBV01 □ □ 31R1211	0.175
-	1	LS3 □ M31D11	1SBV01 □ □ 31R1411	0.175

ø12.5 plastic (polyacetal) roller lever on steel plunger (zinc plated) vertical action

1	-	LS3 □ M32B11	1SBV01 □ □ 32R1211	0.175
-	1	LS3 □ M32D11	1SBV01 □ □ 32R1411	0.175

ø22 plastic (polyacetal) roller lever on steel plunger (zinc plated)

1	-	LS3 □ M38B11	1SBV01 □ □ 38R1211	0.180
-	1	LS3 □ M38D11	1SBV01 □ □ 38R1411	0.180

ø18 plastic (polyacetal) roller lever

1	-	LS3 □ M41B11	1SBV01 □ □ 41R1211	0.230
-	1	LS3 □ M41D11	1SBV01 □ □ 41R1411	0.230

ø50 rubber roller lever

1	-	LS3 □ M42B11	1SBV01 □ □ 42R1211	0.255
-	1	LS3 □ M42D11	1SBV01 □ □ 42R1411	0.255

Adjustable ø18 plastic (polyacetal) roller lever

1	-	LS3 □ M51B11	1SBV01 □ □ 51R1211	0.240
-	1	LS3 □ M51D11	1SBV01 □ □ 51R1411	0.240

Adjustable ø50 rubber roller lever

1	-	LS3 □ M52B11	1SBV01 □ □ 52R1211	0.265
-	1	LS3 □ M52D11	1SBV01 □ □ 52R1411	0.265

Spring rod

1	-	LS3 □ M91B11	1SBV01 □ □ 91R1211	0.180
-	1	LS3 □ M91D11	1SBV01 □ □ 91R1411	0.180

LS4..M.. Limit Switches

Metal Casing IP66 - 40 mm Width



LS40M: 1 cable inlet for Pg 13.5 cable gland 0 1 1
 LS43M: 1 cable inlet for ISO 20 cable gland 3 1 6
 LS45M: 1 cable inlet for 1/2" NPT cable gland 5 3 1

Ordering Details

Contact blocks	Type	Order code	Weight kg
 B11	 D11	state cable inlet code □ □	Pack ^{ing} 1 piece

Stainless steel plain plunger

1	-	LS4 □ M11B11	1SBV01 □ □ 11R1211	0.240
-	1	LS4 □ M11D11	1SBV01 □ □ 11R1411	0.240

ø12 stainless steel roller plunger

1	-	LS4 □ M13B11	1SBV01 □ □ 13R1211	0.240
-	1	LS4 □ M13D11	1SBV01 □ □ 13R1411	0.240

ø22 plastic (polyacetal) roller lever on stainless steel plunger

1	-	LS4 □ M31B11	1SBV01 □ □ 31R1211	0.275
-	1	LS4 □ M31D11	1SBV01 □ □ 31R1411	0.275

ø22 plastic (polyacetal) roller lever

1	-	LS4 □ M41B11	1SBV01 □ □ 41R1211	0.280
-	1	LS4 □ M41D11	1SBV01 □ □ 41R1411	0.280

ø22 stainless steel roller lever

1	-	LS4 □ M42B11	1SBV01 □ □ 42R1211	0.280
-	1	LS4 □ M42D11	1SBV01 □ □ 42R1411	0.280

Adjustable ø22 plastic (polyacetal) roller lever

1	-	LS4 □ M51B11	1SBV01 □ □ 51R1211	0.290
-	1	LS4 □ M51D11	1SBV01 □ □ 51R1411	0.290

Adjustable ø6 plastic (polyacetal) rod lever

1	-	LS4 □ M72B11	1SBV01 □ □ 72R1211	0.285
-	1	LS4 □ M72D11	1SBV01 □ □ 72R1411	0.285

Spring rod

1	-	LS4 □ M91B11	1SBV01 □ □ 91R1211	0.235
-	1	LS4 □ M91D11	1SBV01 □ □ 91R1411	0.235

LS7..M.. Limit Switches

Metal Casing IP66 - 60 mm Width



LS72M11B11

1SBC5 8603 4F0302



LS72M12B11

1SBC5 8604 4F0302



LS72M38B11

1SBC5 8607 4F0302



LS72M45B11

1SBC5 8610 4F0302



LS72M98B11-A

1SBC5 8620 5F0302

LS70M: 3 cable inlets for Pg 13.5 cable gland0 4 2
 LS71M: 3 cable inlets for Pg 11 cable gland1 4 1
 LS72M: 3 cable inlets for ISO 16 cable gland2 4 3
 LS73M: 3 cable inlets for ISO 20 cable gland3 5 2
 LS75M: 3 cable inlets for 1/2" NPT cable gland5 5 1

Ordering Details

Contact blocks	Type	Order code	Weight kg
B11	D11	state cable inlet code □ □	Pack ^{ing} 1 piece

Steel plain plunger (zinc plated)

1	-	LS7 □ M11B11	1SBV01 □ □ 11R1211	0.270
-	1	LS7 □ M11D11	1SBV01 □ □ 11R1411	0.270

Steel roller plunger (zinc plated)

1	-	LS7 □ M12B11	1SBV01 □ □ 12R1211	0.280
-	1	LS7 □ M12D11	1SBV01 □ □ 12R1411	0.280

ø12.5 plastic (polyacetal) roller lever on steel plunger (zinc plated) horizontal action

1	-	LS7 □ M31B11	1SBV01 □ □ 31R1211	0.265
-	1	LS7 □ M31D11	1SBV01 □ □ 31R1411	0.265

ø22 plastic (polyacetal) roller lever on steel plunger (zinc plated)

1	-	LS7 □ M38B11	1SBV01 □ □ 38R1211	0.270
-	1	LS7 □ M38D11	1SBV01 □ □ 38R1411	0.270

ø18 plastic (polyacetal) roller with bent lever

1	-	LS7 □ M45B11	1SBV01 □ □ 45R1211	0.335
-	1	LS7 □ M45D11	1SBV01 □ □ 45R1411	0.335

Adjustable ø3 stainless steel rod lever

1	-	LS7 □ M71B11	1SBV01 □ □ 71R1211	0.380
-	1	LS7 □ M71D11	1SBV01 □ □ 71R1411	0.380

Spring rod

1	-	LS7 □ M91B11	1SBV01 □ □ 91R1211	0.315
-	1	LS7 □ M91D11	1SBV01 □ □ 91R1411	0.315

Pull action with ring

1	-	LS7 □ M98B11-A	1SBV01 □ □ 98R1211	0.350
-	1	LS7 □ M98D11-A	1SBV01 □ □ 98R1411	0.350

Limit Switches Plastic or Metal Casing

Travel and Operation Diagrams

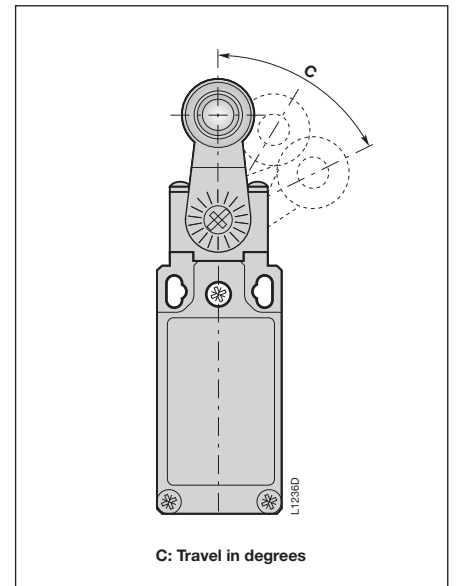
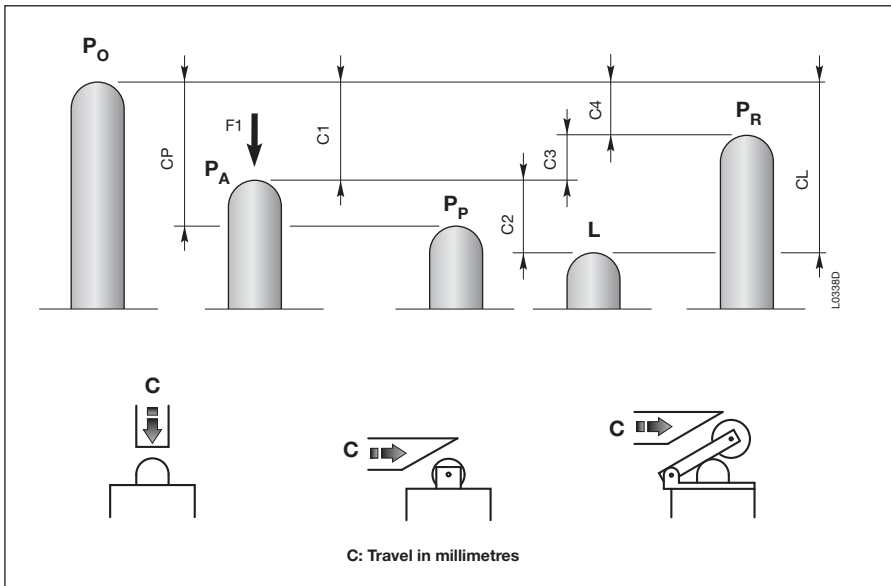

P_O Free position:

position of the switch actuator when no external force is exerted on it.

P_A Operating position:

position of the switch actuator, under the effect of force **F₁**, when the contacts leave their initial free position.

P_P Positive opening position:

position of the switch actuator from which positive opening is ensured.

L Max. travel position:

maximum acceptable travel position of the switch actuator under the effect of a force **F₁**.

P_R Release position:

position of the switch actuator when the contacts return to their initial free position.

C₁ Pre-travel (average travel):

distance between the free position **P_O** and the operating position **P_A**.

C_p Positive opening travel:

minimum travel of the switch actuator, from the free position, to ensure positive opening operation of the normally closed contact (N.C.).

C₂ Over-travel (average travel):

distance between the operating position **P_A** and the max. travel position **L**.

C₁ Max. travel (maximum travel):

distance between the free position **P_O** and the max. travel position **L**.

C₃ Differential travel (C₁-C₄) (average travel):

travel difference of the switch actuator between the operating position **P_A** and the release position **P_R**.

C₄ Release travel (average travel):

distance between the release position **P_R** and the free position **P_O**.

Diagram for snap action contacts:

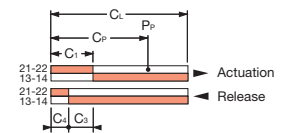
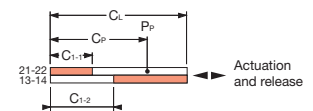

Diagram for non-overlapping slow action contacts:



Contacts position 21-22 █ Contact closed
 21-22 Contact open
 ↓
 Contacts identification (example)

Note: for slow action contacts, **C₃ = 0**, **C₁₋₁** = pre-travel of contact 21-22, **C₁₋₂** = pre-travel of contact 13-14.

Examples:

LS32M13B11
(snap action contacts)

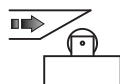
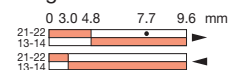

Diagram in millimetres/cam travel



LS32M41B11
(snap action contacts)

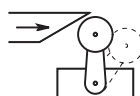
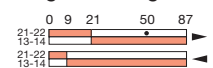

Diagram in degrees/lever rotation



LS32M11D11
(non-overlapping slow action contacts)

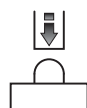
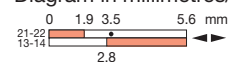

Diagram in millimetres/plunger travel



LS20 ... LS26 Prewired Limit Switches

Plastic Casing IP67 and Metal Casing IP67

Technical Data

General Technical Data

	Plastic Casing	Metal Casing
Standards	IEC 60947-1, IEC 60947-5-1, EN 60947-1, EN 60947-5-1, UL 508 and CSA C22-2 n° 14	
Certifications - Approvals	UL - CSA (only with UL62-1581 cable)	
Air temperature near the device		
– during operation	°C – 25 ... + 70	– 25 ... + 70
– for storage	°C – 40 ... + 70	– 40 ... + 70
Climatic withstand	According to IEC 68-2-3 and salty mist according to IEC 68-2-11	
Mounting positions	All positions are authorized	
Shock withstand (according to IEC 68-2-27 and EN 60068-2-27)	25g* (1/2 sinusoidal shock for 11 ms) no change in contact position	
Resistance to vibrations (acc. to IEC 68-2-6 and EN 60068-2-6)	25g** (10 ... 500 Hz) no change in position of contacts greater than 100 µs	
Protection against electrical shocks (acc. to IEC 536)	Class II	Class I
Degree of protection (according to IEC 529 and EN 60529)	IP67	
Degree of protection (according to UL 50 and NEMA)	Type 1 Enclosure (indoor use)	Type 4 - 4x - 6 Enclosure (Outdoor use)
Consistency (measured over 1 million operations)	0.1 mm (upon closing point)	

Electrical Data

Rated insulation voltage U_i		V	400 (degree of pollution 3)
– according to IEC 60947-1 and EN 60947-1		V	300
– according to UL 508, CSA C22-2 n° 14			
Rated impulse withstand voltage U_{imp}		kV	4
(according to IEC 60947-1 and EN 60947-1)			
Conventional enclosed thermal current I_{the}		A	5
(according to IEC 60947-5-1 and EN 60947-5-1) $\theta \leq 40$ °C			
Short-circuit protection gG type fuses		A	6
Rated operational current			
I_e / AC-15 – acc. to IEC 60947-5-1	24 V - 50/60 Hz	A	5.0
	120 V - 50/60 Hz	A	3.0
	240 V - 50/60 Hz	A	1.5
– acc. to UL 508, CSA C22 n° 14			B 300
I_e / DC-13 – acc. to IEC 60947-5-1	24 V - d.c.	A	1.1
	125 V - d.c.	A	0.22
	250 V - d.c.	A	0.1
– acc. to UL 508, CSA C22 n° 14			R 300
Positivity	Contacts with positive opening operation as per IEC 60947-5-1 chapter 3 and EN 60947-5-1		
Resistance between contacts		mΩ	25
Pre-wired connection		mm ² / AWG	4 x 0.75 mm ² / 4 x AWG 18 5 x 0.75 mm ² / 5 x AWG 18
Type of cable			
– UL 62-1581 (PVC)	Black - Ø ext. 7.20 ± 0.2		Black - Ø ext. 8.20 ± 0.2
– IEC 20/22 II (PVC) (no flame propagation)	Black - Ø ext. 7.20 ± 0.2		Grey - Ø ext. 8.20 ± 0.2
Terminal marking	According to EN 50013		
Mechanical durability	10 Millions of operations		
Electrical durability (according to IEC 60947-5-1 appendix C)	Utilization categories AC-15 and DC-13 (See curves and values below)		
– max. switching frequency		Cycles/h	3600
– load factor			0.5

* Shock: 25g for LS20P/M... .. LS26P/M.. with D11 contact block
5g for LS20P/M... .. LS26P/M.. with B11 contact block

** Vibrations: except for LS20P/M93 ... LS26P/M93 : 15 g

Electrical durability for AC-15 utilization category

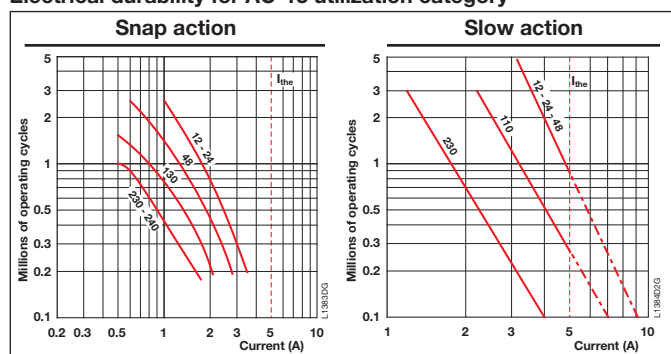

Electrical durability for DC-13 utilization category

	Snap action	Slow action
Power breaking for a durability of 5 million operating cycles		
Voltage 24 V	5.7 W	7.2 W
Voltage 48 V	4.1 W	5.4 W
Voltage 110 V	2.2 W	3.6 W

LS3..., LS4... and LS7... Limit Switches

Plastic Casing IP65 and Metal Casing IP66

Technical Data

General Technical Data

	Plastic Casing	Metal Casing
Standards	IEC 60947-1, IEC 60947-5-1, EN 60947-1, EN 60947-5-1, UL 508 and CSA C22-2 n° 14	
Certifications - Approvals	UL - CSA - CCC	
Air temperature near the device		
– during operation	°C – 25 ... + 70	– 25 ... + 70
– for storage	°C – 30 ... + 80	– 30 ... + 80
Climatic withstand	According to IEC 68-2-3 and salty mist according to IEC 68-2-11	
Mounting positions	All positions are authorized	
Shock withstand (according to IEC 68-2-27 and EN 60068-2-27) g	50g* (1/2 sinusoidal shock for 11 ms) no change in contact position	
Resistance to vibrations (acc. to IEC 68-2-6 and EN 60068-2-6) g	25g (10 ... 500 Hz) no change in position of contacts greater than 100 µs	
Protection against electrical shocks (acc. to IEC 536)	Class II	Class I
Degree of protection (according to IEC 529 and EN 60529)	IP65	IP66 **
Consistency (measured over 1 million operations)	0.1 mm (upon closing point)	0.1 mm (upon closing point)

Electrical Data

Rated insulation voltage U_i			
– according to IEC 60947-1 and EN 60947-1	V	500 (degree of pollution 3)	400 (LS3..M.. & LS7..M..), 500 (LS4xM..) - (degree of pollution 3)
– according to UL 508, CSA C22-2 n° 14	V	600	300 (LS3..M.. & LS7..M..), 600 (LS4..M..)
Rated impulse withstand voltage U_{imp} (according to IEC 60947-1 and EN 60947-1)	kV	6	
Conventional enclosed thermal current I_{the} (according to IEC 60947-5-1 and EN 60947-5-1) ≤ 40 °C	A	10	
Short-circuit protection gG type fuses	A	10	
Rated operational current			
I_e / AC-15 – acc. to IEC 60947-5-1			
24 V - 50/60 Hz	A	10	
130 V - 50/60 Hz	A	5.5	
230 V - 50/60 Hz	A	3.1	
240 V - 50/60 Hz	A	3	
400 V - 50/60 Hz	A	1.8	
– acc. to UL 508, CSA C22 n° 14		A 600	A 300 (LS3..M.. & LS7..M..), A 600 (LS4..M..)
I_e / DC-13 – acc. to IEC 60947-5-1			
24 V - d.c.	A	2.8	
110 V - d.c.	A	0.6	
250 V - d.c.	A	0.27	
– acc. to UL 508, CSA C22 n° 14		Q 600	Q 300 (LS3..M.. & LS7..M..), Q 600 (LS4..M..)
Positivity		Contacts with positive opening operation as per IEC 60947-5-1 chapter 3 and EN 60947-5-1	
Resistance between contacts	mΩ	25	
Mechanical durability	Millions of operations	15 } 3x } P { 10...12 ; 30...38 10 } LS } P { 13 ; 41...46 ; 51...55 ; 61...78 > 5 } 7x } P { 14 ; 91...92 ; 98	15 } 3x } M { 11...12 ; 31...38 10 } LS } M { 13 ; 41...46 ; 51...55 ; 61...78 > 5 } 7x } M { 14 ; 91...92 ; 98
	Millions of operations	15 } 4x } P { 11 ; 12 ; 31...33 10 } LS } P { 13 ; 41...44 ; 51...55 ; 61...74 > 5 } 4x } P { 14 ; 19 ; 34...36 ; 91...93	30 } 4x } M { 11...13 ; 21...23 ; 31...33 25 } LS } M { 41...44 ; 51...55 ; 61...74 10 } 4x } M { 91...93
Electrical durability (according to IEC 60947-5-1 appendix C)		Utilization categories AC-15 and DC-13 (see curves and values below)	
– max. switching frequency	Cycles/h	3600	
– load factor		0.5	
Connecting data of contact blocks			
Connecting terminals		M3.5 (+,-) pozidriv 2 screw with cable clamp	
Connecting capacity	1 or 2 x mm ² / AWG	0.5 mm ² / AWG 20 to 2.5 mm ² / AWG 14	
Terminal marking		According to EN 50013	

* Except for LS3..M42, M52 and M55 - LS3..P42, P52 and P55 - LS7..M42, M52 and M55 - LS7..P42, P52 and P55: 25g

** Except for LS3..M52, M55, M73, M74 and M92 - LS7..M52, M55, M73, M74 and M92 - LS4..M54, M72, M92 and M93 : the degree of protection is IP65.

Electrical durability for AC-15 utilization category

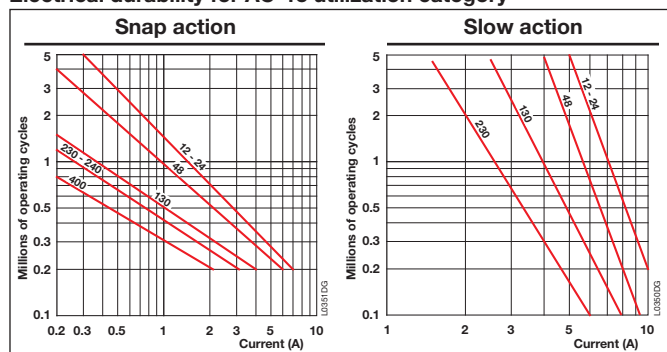

Electrical durability for DC-13 utilization category

	Snap action	Slow action
	Power breaking for a durability of 5 million operating cycles	
Voltage 24 V	9.5 W	12 W
Voltage 48 V	6.8 W	9 W
Voltage 110 V	3.6 W	6 W

LS2..P.. and LS2..M.. Limit Switches

Plastic Casing and Metal Casing - IP67 - 30 mm Width
Prewired

Movement to be detected:

For Plastic Casing:

Cable: 4 x 0.75 mm² / 4 x AWG 18
Length: 1 m
(Other lengths see ordering details)

For Metal Casing:

Cable: 5 x 0.75 mm² / 5 x AWG 18
Length: 1 m
(Other lengths see ordering details)

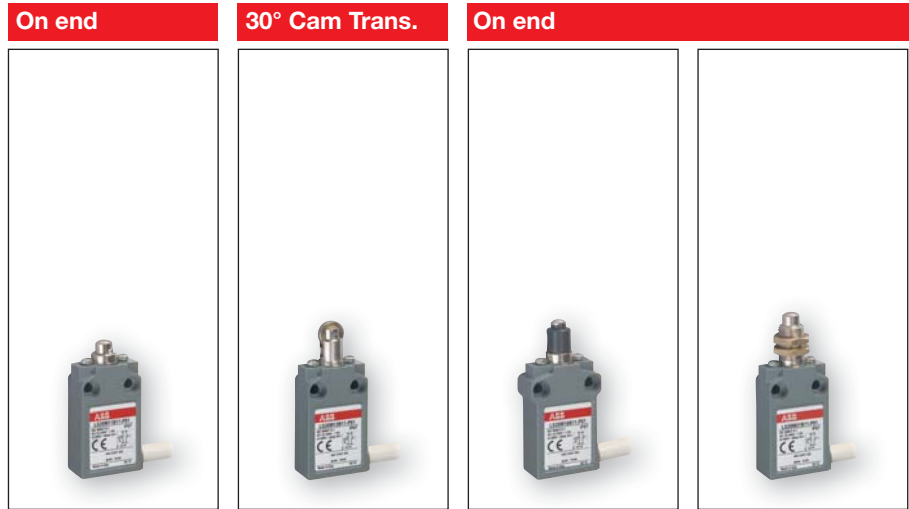

Actuator

	Metal plunger	Metal Roller plunger	Metal plunger (with dust protection cup)	Metal plunger with fixing nuts
↻ (N.C. contact with positive opening operation)	↻	↻	↻	↻
Maximum actuation speed	0.5 m/s	0.1 m/s	0.5 m/s	0.5 m/s
Min. force / torque: - actuation	15 N	10 N	15 N	15 N
- positive opening operation	30 N	30 N	30 N	30 N

Additional Technical Data

Cable output left / right code.....	<input type="checkbox"/> 0
Cable output bottom code.....	<input type="checkbox"/> 1
Plastic casing.....	<input type="checkbox"/> P
Metal casing.....	<input type="checkbox"/> M
IEC 20/22 II PVC cable code.....	<input type="checkbox"/> P
UL 62 PVC cable code.....	<input type="checkbox"/> U

Type to be completed with the above codes <input type="checkbox"/>					
Snap action contacts	Type	LS2□□11B11-□01	LS2□□12B11-□01	LS2□□16B11-□01	LS2□□21B11-□01
	Operation diagram				
Non-overlapping Slow action contacts	Type	LS2□□11D11-□01	LS2□□12D11-□01	LS2□□16D11-□01	LS2□□21D11-□01
	Operation diagram				
Weight (1) (packing per unit)	kg	0.125	0.130	0.125	0.140

(1) add 0.050 kg with metal casing.

Closed contact / Open contact

Dimensions (mm)

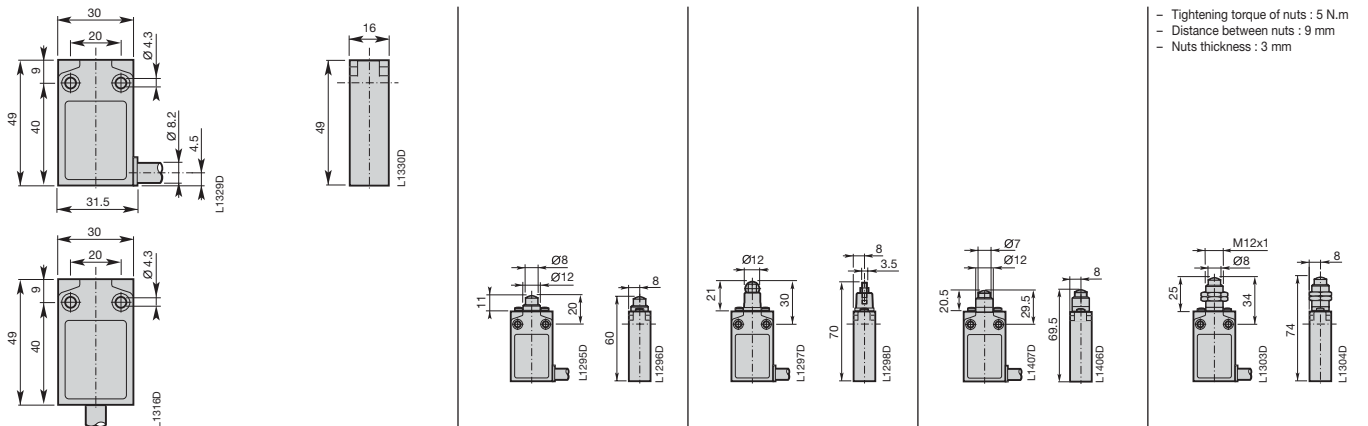

LS2..P.. and LS2..M.. Limit Switches

Plastic Casing and Metal Casing - IP67 - 30 mm Width
Prewired

Movement to be detected:

30° Cam Translation Movement

Multidirectional

For Plastic Casing:

Cable: 4 x 0.75 mm² / 4 x AWG 18
Length: 1 m
(Other lengths see ordering details)

For Metal Casing:

Cable: 5 x 0.75 mm² / 5 x AWG 18
Length: 1 m
(Other lengths see ordering details)



Actuator

	Metal Roller plunger with fixing nuts	ø14 plastic roller lever	Adjustable ø18 plastic roller lever	Spring rod
↻ (N.C. contact with positive opening operation)	↻	↻	↻	-
Maximum actuation speed	0.1 m/s	1.5 m/s	1.5 m/s	1.0 m/s
Min. force / torque: - actuation	10 N	0.08 N.m	0.08 N.m	0.10 N.m
- positive opening operation	30 N	0.28 N.m	0.28 N.m	-

Additional Technical Data

Cable output left / right code.....	<input type="checkbox"/> 0
Cable output bottom code.....	<input type="checkbox"/> 1
Plastic casing.....	<input type="checkbox"/> P
Metal casing.....	<input type="checkbox"/> M
IEC 20/22 II PVC cable code.....	<input type="checkbox"/> P
UL 62 PVC cable code.....	<input type="checkbox"/> U

Type to be completed with the above codes <input type="checkbox"/>					
Snap action contacts	Type	LS2□□22B11-□01	LS2□□41B11-□01	LS2□□51B11-□01	LS2□□91B11-□01
	Operation diagram				
Non-overlapping Slow action contacts	Type	LS2□□22D11-□01	LS2□□41D11-□01	LS2□□51D11-□01	-
	Operation diagram				-
Weight (1) (packing per unit)	kg	0.145	0.175	0.190	0.190

(1) add 0.050 kg with metal casing.

Closed contact / Open contact

Dimensions (mm)

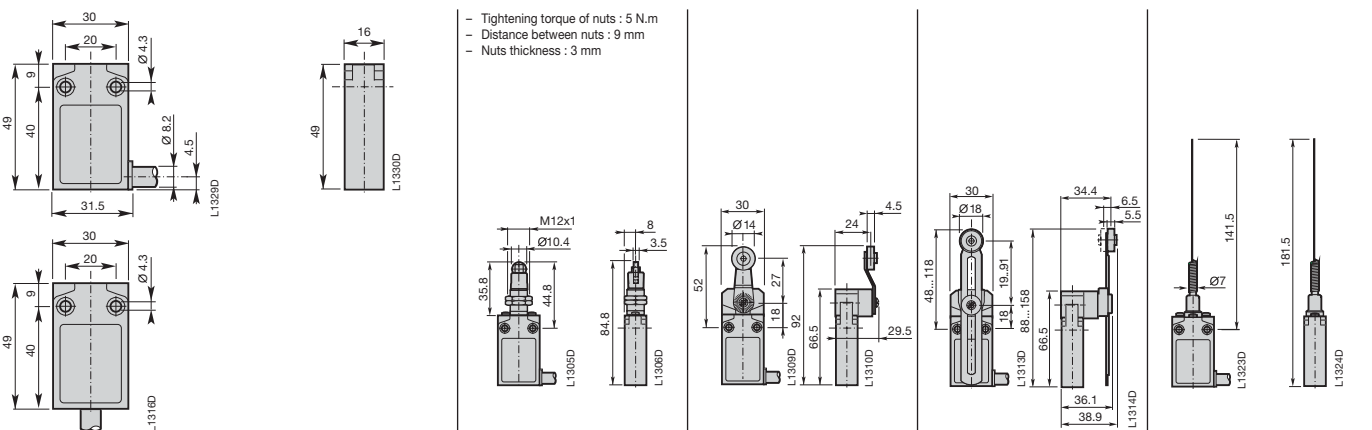

LS2..P.. and LS2..M.. Limit Switches

Plastic Casing and Metal Casing - IP67 - 35 mm Width
Prewired

Movement to be detected:

For Plastic Casing:

Cable: 4 x 0.75 mm² / 4 x AWG 18
Length: 1 m
(Other lengths see ordering details)

For Metal Casing:

Cable: 5 x 0.75 mm² / 5 x AWG 18
Length: 1 m
(Other lengths see ordering details)

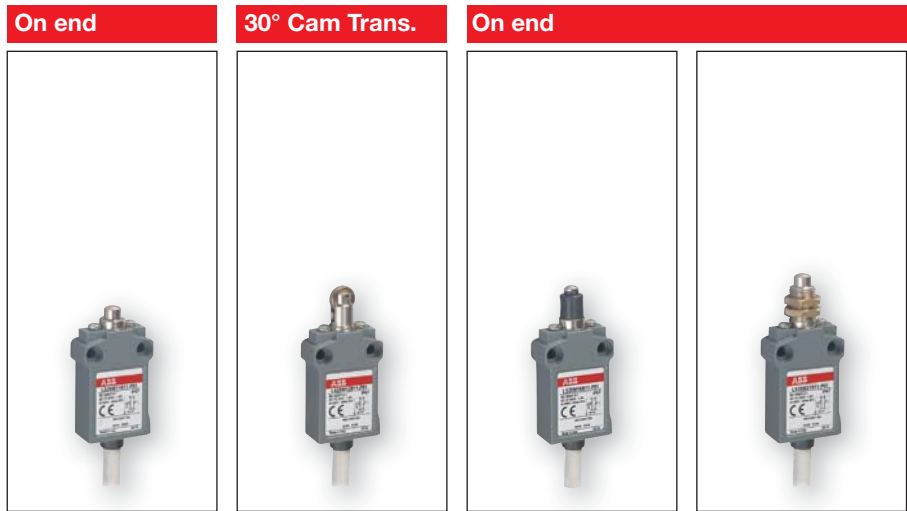

Actuator

	Metal plunger	Metal Roller plunger	Metal plunger (with dust protection cup)	Metal plunger with fixing nuts
⊕ (N.C. contact with positive opening operation)	⊕	⊖	⊕	⊖
Maximum actuation speed	0.5 m/s	0.1 m/s	0.5 m/s	0.5 m/s
Min. force / torque: - actuation	15 N	10 N	15 N	15 N
- positive opening operation	30 N	30 N	30 N	30 N

Additional Technical Data

Cable output left / right code.....	<input type="checkbox"/> 5
Cable output bottom code.....	<input type="checkbox"/> 6
Plastic casing.....	<input type="checkbox"/> P
Metal casing.....	<input type="checkbox"/> M
IEC 20/22 II PVC cable code.....	<input type="checkbox"/> P
UL 62 PVC cable code.....	<input type="checkbox"/> U

Type to be completed with the above codes <input type="checkbox"/>					
Snap action contacts	Type	LS2□□11B11-□01	LS2□□12B11-□01	LS2□□16B11-□01	LS2□□21B11-□01
	Operation diagram				
Non-overlapping Slow action contacts	Type	LS2□□11D11-□01	LS2□□12D11-□01	LS2□□16D11-□01	LS2□□21D11-□01
	Operation diagram				
Weight (1) (packing per unit)	kg	0.125	0.130	0.125	0.140

(1) add 0.050 kg with metal casing.

Closed contact / Open contact

Dimensions (mm)

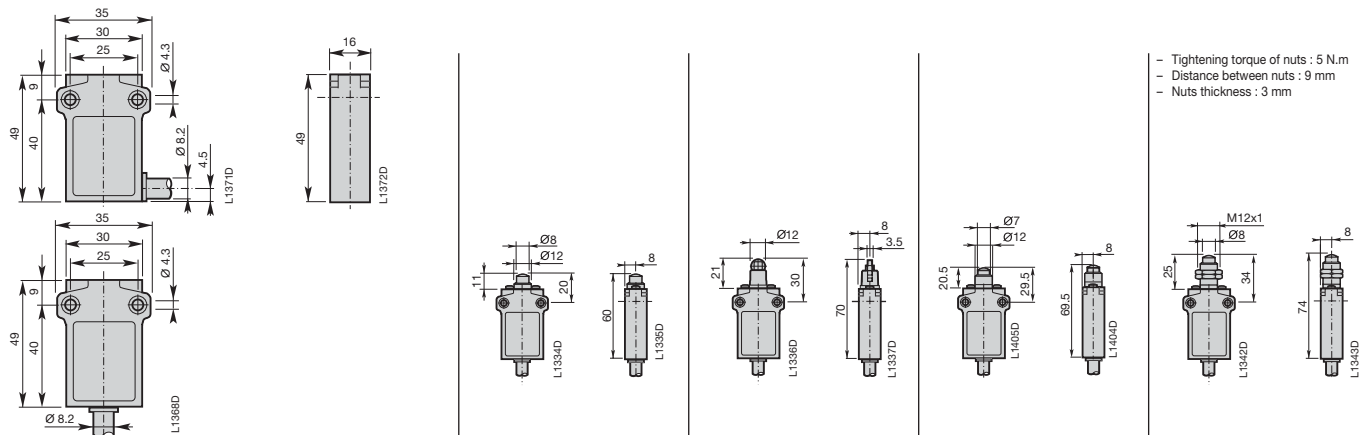

- Tightening torque of nuts : 5 N.m
- Distance between nuts : 9 mm
- Nuts thickness : 3 mm

LS2..P.. and LS2..M.. Limit Switches

Plastic Casing and Metal Casing - IP67 - 35 mm Width
Prewired

Movement to be detected:

30° Cam Translation

Multidirectional

For Plastic Casing:

Cable: 4 x 0.75 mm² / 4 x AWG 18
Length: 1 m
(Other lengths see ordering details)

For Metal Casing:

Cable: 5 x 0.75 mm² / 5 x AWG 18
Length: 1 m
(Other lengths see ordering details)

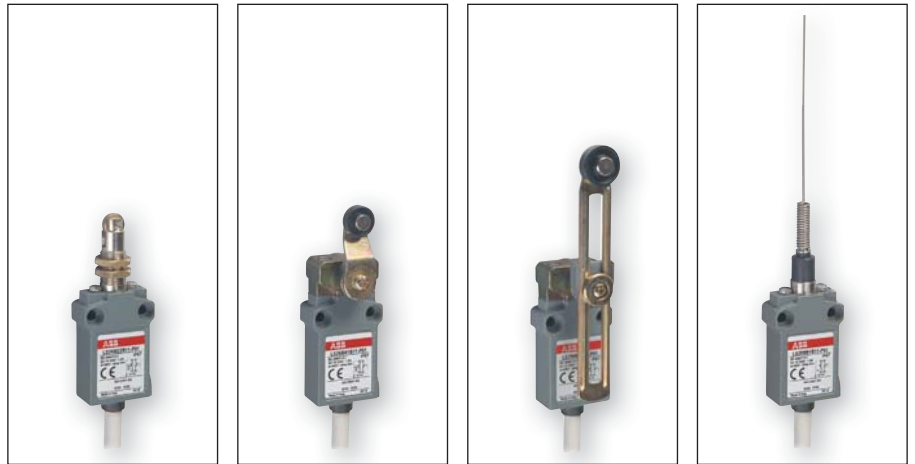

Actuator

	Metal Roller plunger with fixing nuts	ø14 plastic roller lever	Adjustable ø18 plastic roller lever	Spring rod
⊕ (N.C. contact with positive opening operation)	⊕	⊕	⊕	-
Maximum actuation speed	0.1 m/s	1.5 m/s	1.5 m/s	1.0 m/s
Min. force / torque: - actuation	10 N	0.08 N.m	0.08 N.m	0.10 N.m
- positive opening operation	30 N	0.28 N.m	0.28 N.m	-

Additional Technical Data

Cable output left / right code.....	<input type="checkbox"/> 5
Cable output bottom code.....	<input type="checkbox"/> 6
Plastic casing.....	<input type="checkbox"/> P
Metal casing.....	<input type="checkbox"/> M
IEC 20/22 II PVC cable code.....	<input type="checkbox"/> P
UL 62 PVC cable code.....	<input type="checkbox"/> U

Type to be completed with the above codes <input type="checkbox"/>					
Snap action contacts	Type	LS2□□22B11-□01	LS2□□41B11-□01	LS2□□51B11-□01	LS2□□91B11-□01
	Operation diagram				
Non-overlapping Slow action contacts	Type	LS2□□22D11-□01	LS2□□41D11-□01	LS2□□51D11-□01	-
	Operation diagram				-
Weight (1) (packing per unit)	kg	0.200	0.200	0.230	0.235

(1) add 0.050 kg with metal casing.

Dimensions (mm)

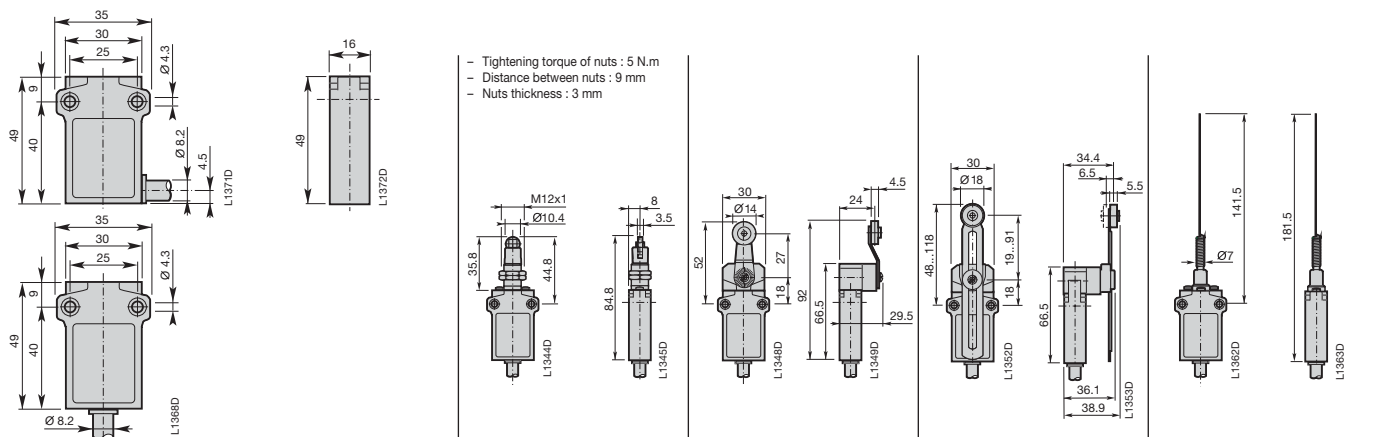



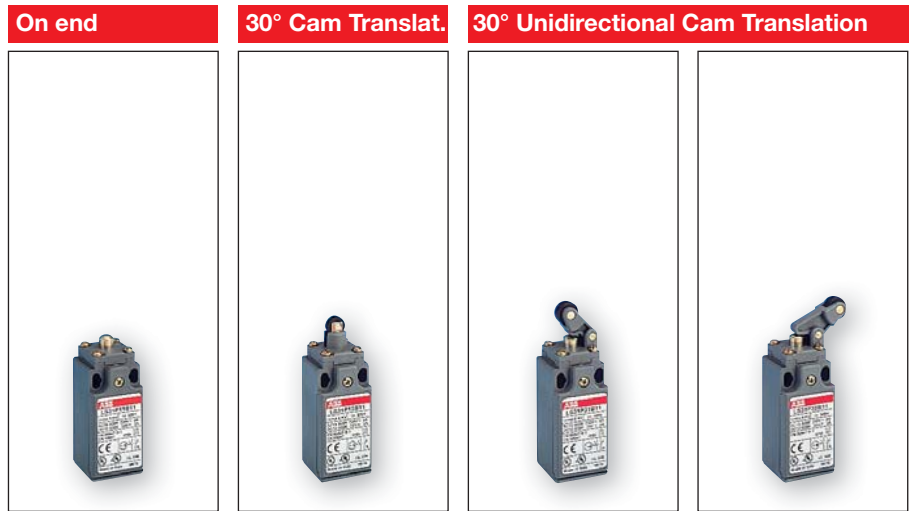

LS3..P.. Limit Switches

Double Insulation  - Plastic Casing IP65 - 30 mm Width
1 Cable Inlet for Cable Gland





Movement to be detected:











Actuator

	Metal plunger	Ø11 plastic roller plunger	Ø12.5 plastic roller lever on steel plunger	Ø12.5 plastic roller lever on steel plunger
Conformity /  (N.C. contact with positive opening operation)	EN 50047 (B shape) 	EN 50047 (C shape) 	EN 50047 (E shape) 	- 
Maximum actuation speed	0.5 m/s	0.3 m/s	1 m/s	1 m/s
Min. force / torque: - actuation	15 N	12 N	7 N	7 N
- positive opening operation	45 N	41 N	24 N	24 N

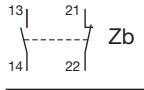
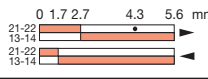
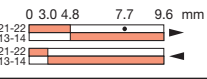
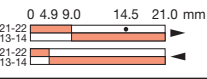
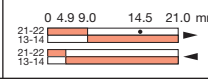
Additional Technical Data

LS type code to be complete with the cable inlet code  = Pg 13.5
 = Pg 11
 = M16 x 1.5
 = M20 x 1.5
 = 1/2" NPT (by plastic adaptor)

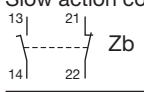
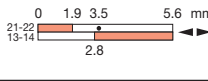
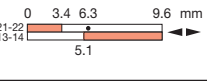
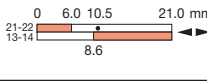
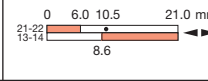
Snap action contacts	Type	LS3  P11B11	LS3  P13B11	LS3  P31B11	LS3  P32B11
	Operation diagram				
Non-overlapping Slow action contacts	Type	LS3  P11D11	LS3  P13D11	LS3  P31D11	LS3  P32D11
	Operation diagram				
Weight (packing per unit)	kg	0.070	0.070	0.070	0.075

Special heads, accessories and special contact arrangement or particular function: please consult us.

 Closed contact /  Open contact

Dimensions (mm)

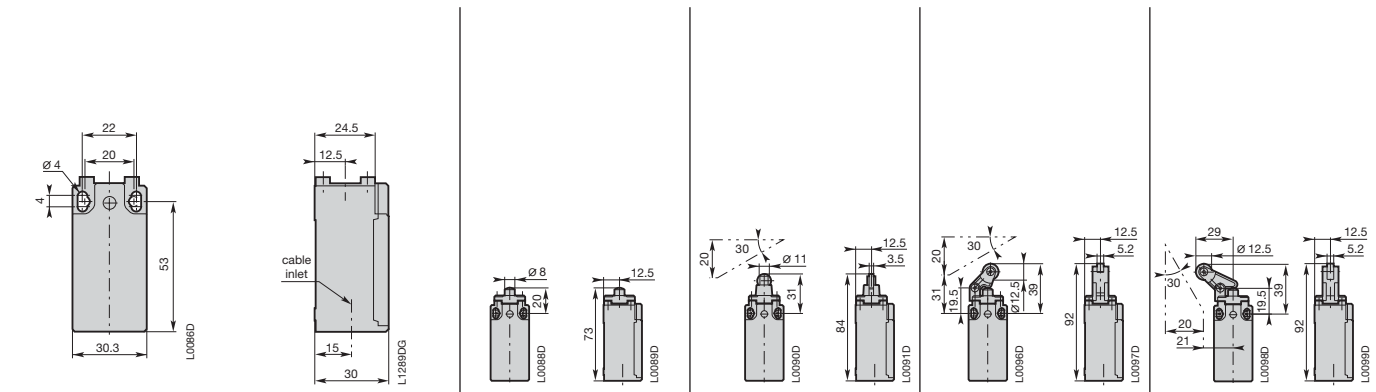







LS3..P.. Limit Switches

Double Insulation □ - Plastic Casing IP65 - 30 mm Width
1 Cable Inlet for Cable Gland

30° Cam Translation Movement

Fully Direction Trans.

Multidirectional

					
ø18 plastic roller lever	ø50 rubber roller lever	Adjustable ø18 plastic roller lever	Adjustable ø50 rubber roller lever	Adjustable ø3 fibre-glass rod lever	Spring rod lever
EN 50047 (A shape) → 1.5 m/s 0.1 N.m 0.32 N.m	→ 1.5 m/s 0.1 N.m 0.32 N.m	→ 1.5 m/s 0.1 N.m 0.32 N.m	→ 1.5 m/s 0.1 N.m 0.32 N.m	→ 1.5 m/s 0.1 N.m 0.32 N.m	→ 1 m/s 0.12 N.m -

LS type code to be complete with the cable inlet code
 0 = Pg 13.5
 1 = Pg 11
 2 = M16 x 1.5
 3 = M20 x 1.5
 5 = 1/2" NPT (by plastic adaptor)

LS3 □ P41B11 0 17° 31° 47° 74° 21-22 13-14 21-22 13-14	LS3 □ P42B11 0 17° 31° 47° 74° 21-22 13-14 21-22 13-14	LS3 □ P51B11 0 17° 31° 47° 74° 21-22 13-14 21-22 13-14	LS3 □ P52B11 0 17° 31° 47° 74° 21-22 13-14 21-22 13-14	LS3 □ P72B11 0 17° 31° 47° 74° 21-22 13-14 21-22 13-14	LS3 □ P91B11 0 12° 23° 36° 21-22 13-14 21-22 13-14
LS3 □ P41D11 0 21° 37° 74° 21-22 13-14 30°	LS3 □ P42D11 0 21° 37° 74° 21-22 13-14 30°	LS3 □ P51D11 0 21° 37° 74° 21-22 13-14 30°	LS3 □ P52D11 0 21° 37° 74° 21-22 13-14 30°	LS3 □ P72D11 0 21° 37° 74° 21-22 13-14 30°	LS3 □ P91D11 0 14° 36° 21-22 13-14 21°
0.090	0.120	0.100	0.130	0.100	0.080

Special heads, accessories and special contact arrangement or particular function: please consult us.

■ Closed contact / □ Open contact

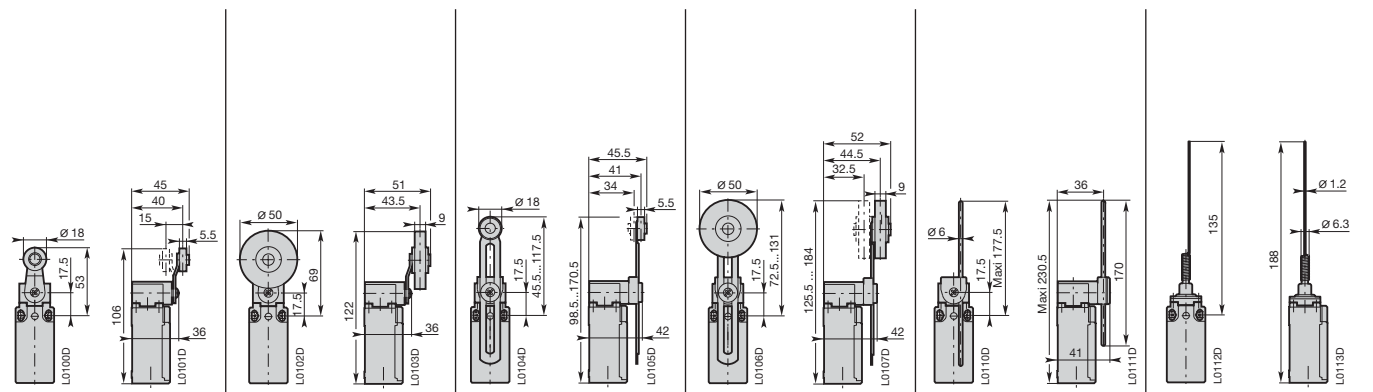

LS4..P.. Limit Switches

Double Insulation □ - Plastic Casing IP65 - 40 mm Width
1 Cable Inlet for Cable Gland

Movement to be detected:



Actuator

	Metal plunger	Ø12 stainless steel roller plunger	Polyamide roller lever on steel plunger	Ø22 plastic roller lever
Conformity / (N.C. contact with positive opening operation)	EN 50041 (B shape)	EN 50041 (C shape)	-	EN 50041 (A shape)
Maximum actuation speed	0.5 m/s	0.5 m/s	1 m/s	1.5 m/s
Min. force / torque: - actuation	14 N	14 N	8 N	0.15 N.m
- positive opening operation	45 N	40 N	40 N	0.30 N.m

Additional Technical Data

LS type code to be complete with the cable inlet code
 □ = Pg 13.5
 3 = M20 x 1.5
 5 = 1/2" NPT

Snap action contacts	Type	LS4 □ P11B11	LS4 □ P13B11	LS4 □ P31B11	LS4 □ P41B11
	Operation diagram				
Non-overlapping Slow action contacts	Type	LS4 □ P11D11	LS4 □ P13D11	LS4 □ P31D11	LS4 □ P41D11
	Operation diagram				
Weight (packing per unit)	kg	0.140	0.145	0.175	0.185

Special heads, accessories and special contact arrangement or particular function: please consult us.

Closed contact / Open contact

Dimensions (mm)

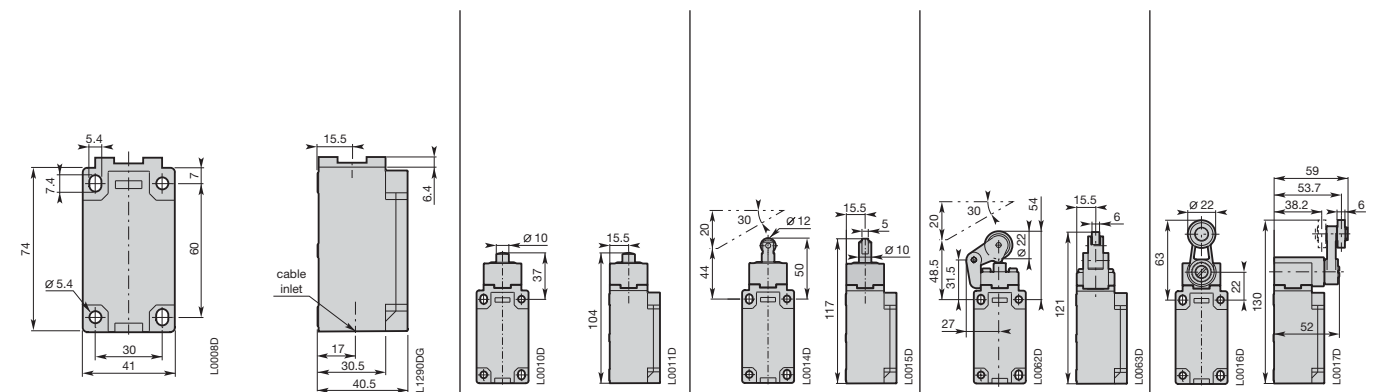

LS4..P.. Limit Switches





Double Insulation  - Plastic Casing IP65 - 40 mm Width
1 Cable Inlet for Cable Gland

Movement to be detected:

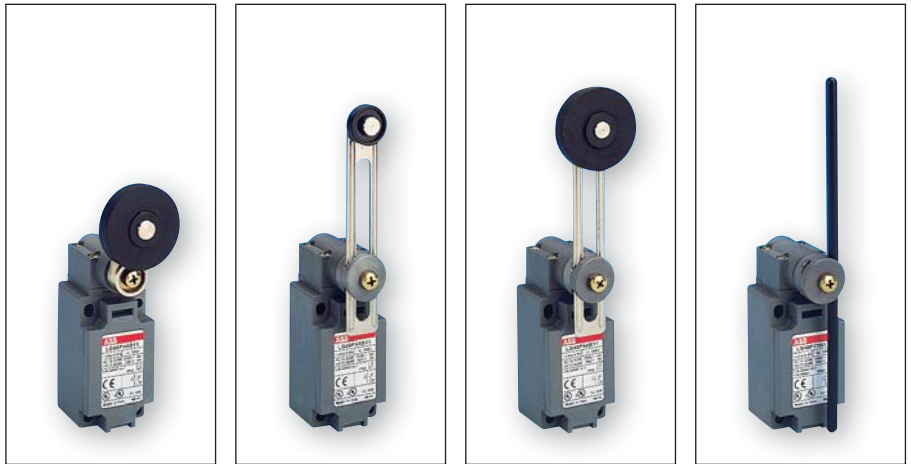
30° Cam Translation Movement









Fully Direction Trans.

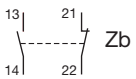
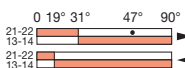
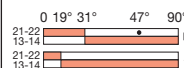
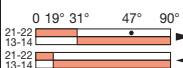
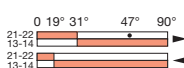

Actuator	ø50 rubber roller lever	Adjustable ø22 plastic roller lever	Adjustable ø50 rubber roller lever	Adjustable ø6 plastic rod lever
Conformity /  (N.C. contact with positive opening operation)	- 	- 	- 	EN 50041 (D shape) 
Maximum actuation speed	1.5 m/s	1.5 m/s	1.5 m/s	1.5 m/s
Min. force / torque: - actuation	0.15 N.m	0.15 N.m	0.15 N.m	0.15 N.m
- positive opening operation	0.30 N.m	0.30 N.m	0.30 N.m	0.30 N.m

Additional Technical Data

LS type code to be complete with the cable inlet code **0** = Pg 13.5
3 = M20 x 1.5
5 = 1/2" NPT

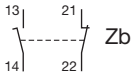
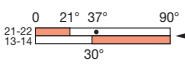
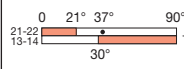
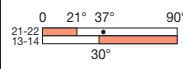
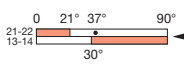
Snap action contacts	Type	LS4  P44B11	LS4  P51B11	LS4  P54B11	LS4  P72B11
 Zb	Operation diagram				
Non-overlapping Slow action contacts	Type	LS4  P44D11	LS4  P51D11	LS4  P54D11	LS4  P72D11
 Zb	Operation diagram				
Weight (packing per unit)	kg	0.205	0.190	0.200	0.185

Special heads, accessories and special contact arrangement or particular function: please consult us.

 Closed contact /  Open contact

Dimensions (mm)

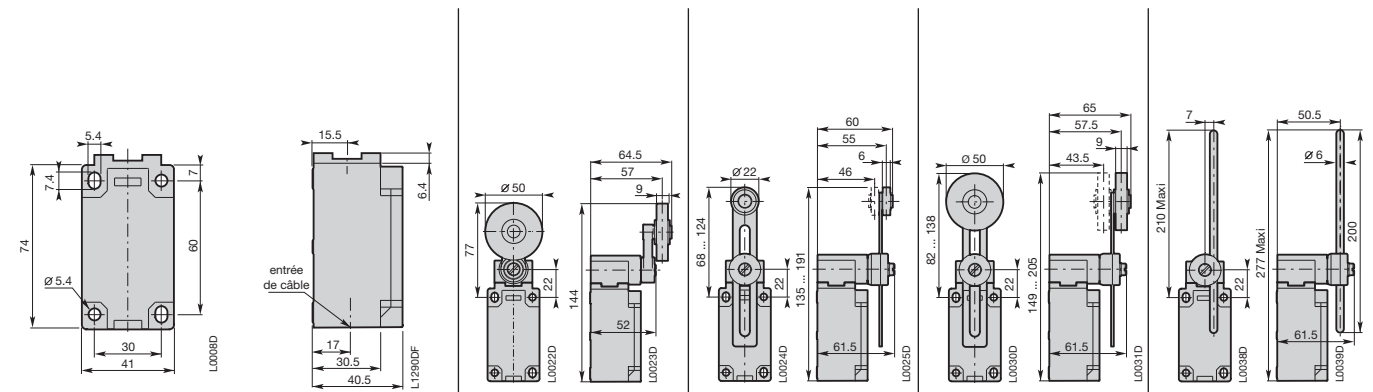

LS7..P.. Limit Switches

Double Insulation  - Plastic Casing IP65 - 60 mm Width
2 Cable Inlets for Cable Gland

Movement to be detected:





Actuator

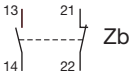

	Metal plunger	ø11 plastic roller plunger	ø12.5 plastic roller lever on steel plunger	ø18 plastic roller lever
Conformity /  (N.C. contact with positive opening operation)	-	-	-	-
Maximum actuation speed	0.5 m/s	0.3 m/s	1 m/s	1.5 m/s
Min. force / torque: - actuation	15 N	12 N	7 N	0.1 N.m
- positive opening operation	45 N	41 N	24 N	0.32 N.m

Additional Technical Data

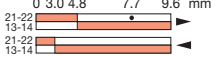
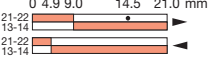
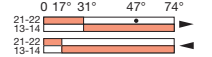
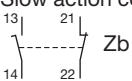
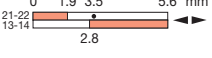
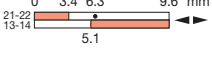
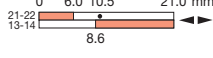
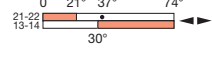
LS type code to be complete with the cable inlet code
 0 = Pg 13.5
 1 = Pg 11
 2 = M16 x 1.5
 3 = M20 x 1.5
 5 = 1/2" NPT

Snap action contacts	Type	LS7 □ P11B11	LS7 □ P13B11	LS7 □ P31B11	LS7 □ P41B11
	Operation diagram				
Non-overlapping Slow action contacts	Type	LS7 □ P11D11	LS7 □ P13D11	LS7 □ P31D11	LS7 □ P41D11
	Operation diagram				
Weight (packing per unit)	kg	0.100	0.100	0.105	0.125

Special heads, accessories and special contact arrangement or particular function: please consult us.





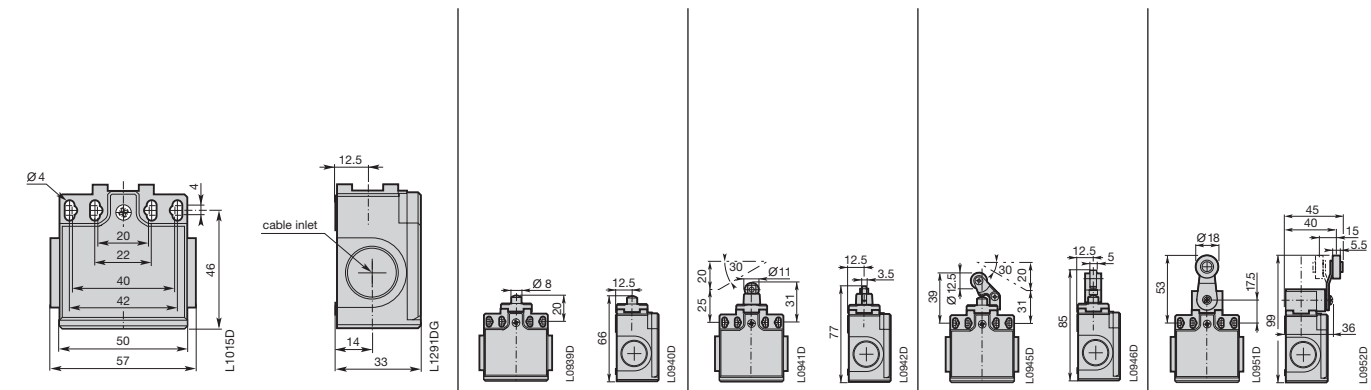

 Closed contact /  Open contact

Dimensions (mm)















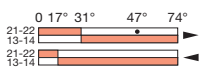
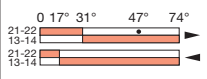
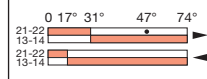
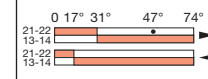
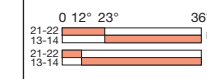

LS7..P.. Limit Switches

Double Insulation  - Plastic Casing IP65 - 60 mm Width
2 Cable Inlets for Cable Gland

30° Cam Translation Movement		Fully Direction Trans.		Multidirectional		Pull action	
							
ø50 rubber roller lever	Adjustable ø18 plastic roller lever	Adjustable ø50 rubber roller lever	Adjustable ø3 fibre-glass rod lever	Spring rod lever	Pull action with ring		
1.5 m/s 0.1 N.m 0.32 N.m	1.5 m/s 0.1 N.m 0.32 N.m	1.5 m/s 0.1 N.m 0.32 N.m	1.5 m/s 0.1 N.m 0.32 N.m	1 m/s 0.12 N.m -	0.5 m/s 30 N -		

LS type code to be complete with the cable inlet code 0 = Pg 13.5

- 1 = Pg 11
- 2 = M16 x 1.5
- 3 = M20 x 1.5
- 5 = 1/2" NPT

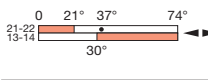
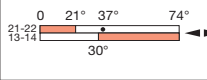
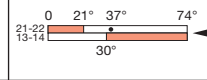
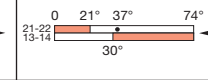
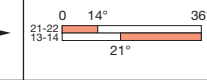
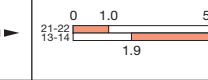
LS7  P42B11	LS7  P51B11	LS7  P52B11	LS7  P72B11	LS7  P91B11	LS7  P98B11-A
					
LS7  P42D11	LS7  P51D11	LS7  P52D11	LS7  P72D11	LS7  P91D11	LS73  P98D11-A
					
0.145	0.135	0.155	0.120	0.110	0.145

Special heads, accessories and special contact arrangement or particular function: please consult us.

 Closed contact /  Open contact

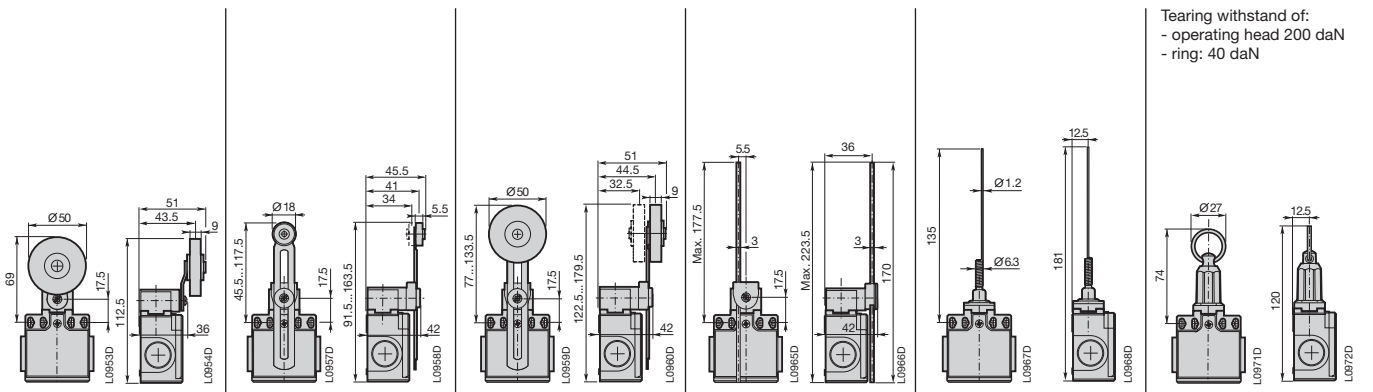

LS3..M.. Limit Switches

Metal Casing IP66 - 30 mm Width
1 Cable Inlet for Cable Gland

Movement to be detected:



Actuator

	Metal plunger	Metal roller plunger	ø12.5 plastic roller lever on steel plunger	ø12.5 plastic roller lever on steel plunger
Conformity / (N.C. contact with positive opening operation)	EN 50047 (B shape)	EN 50047 (C shape)	EN 50047 (E shape)	-
Maximum actuation speed	0.5 m/s	0.3 m/s	1 m/s	1 m/s
Min. force / torque: - actuation	15 N	12 N	7 N	7 N
- positive opening operation	45 N	41 N	24 N	24 N

Additional Technical Data

LS type code to be complete with the cable inlet code [0] = Pg 13.5
[1] = Pg 11
[2] = M16 x 1.5
[3] = M20 x 1.5
[5] = 1/2" NPT

Snap action contacts	Type	LS3 □ M11B11	LS3 □ M12B11	LS3 □ M31B11	LS3 □ M32B11
	Operation diagram				
Non-overlapping Slow action contacts	Type	LS3 □ M11D11	LS3 □ M12D11	LS3 □ M31D11	LS3 □ M32D11
	Operation diagram				
Weight (packing per unit)	kg	0.180	0.185	0.175	0.175

Special heads, accessories and special contact arrangement or particular function: please consult us.

Closed contact / Open contact

Dimensions (mm)

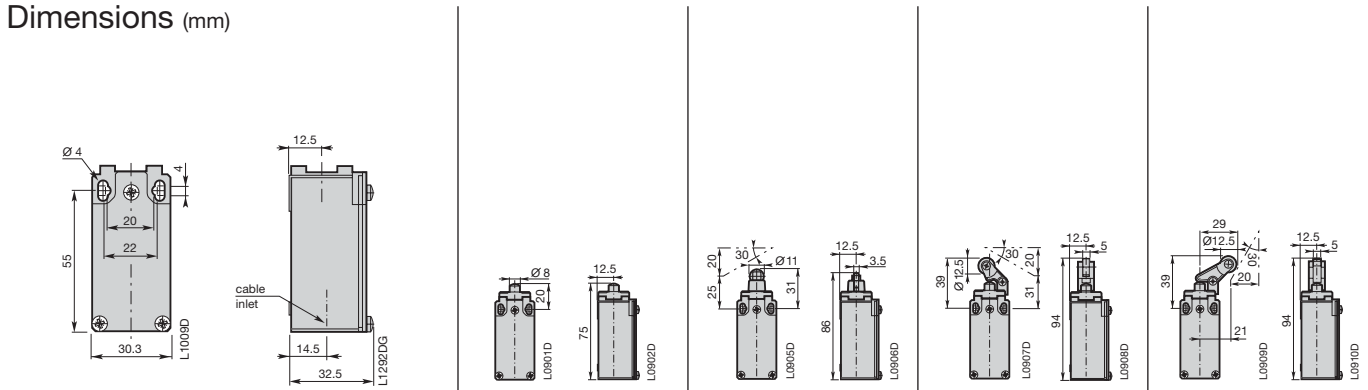

LS3..M.. Limit Switches

Metal Casing IP66 - 30 mm Width
1 Cable Inlet for Cable Gland

Unidirectional	30° Cam Translation Movement				Multidirectional
ø22 plastic roller lever on steel plunger	ø18 plastic roller lever	ø50 rubber roller lever	Adjustable ø18 plastic roller lever	Adjustable ø50 rubber roller lever	Spring rod lever
1 m/s 7 N 24 N	EN 50047 (A shape) 1.5 m/s 0.1 N.m 0.32 N.m	1.5 m/s 0.1 N.m 0.32 N.m	1.5 m/s 0.1 N.m 0.32 N.m	1.5 m/s 0.1 N.m 0.32 N.m	1 m/s 0.12 N.m -

LS type code to be complete with the cable inlet code [0] = Pg 13.5

- [1] = Pg 11
- [2] = M16 x 1.5
- [3] = M20 x 1.5
- [5] = 1/2" NPT

LS3 □ M38B11 0 8.8 15.0 23.2 32.0 mm 21-22 13-14 21-22 13-14	LS3 □ M41B11 0 17° 31° 47° 74° 21-22 13-14 21-22 13-14	LS3 □ M42B11 0 17° 31° 47° 74° 21-22 13-14 21-22 13-14	LS3 □ M51B11 0 17° 31° 47° 74° 21-22 13-14 21-22 13-14	LS3 □ M52B11 0 17° 31° 47° 74° 21-22 13-14 21-22 13-14	LS3 □ M91B11 0 12° 23° 36° 21-22 13-14 21-22 13-14
LS3 □ M38D11 0 10.6 18.5 32.0 mm 21-22 13-14 15.1	LS3 □ M41D11 0 21° 37° 74° 21-22 13-14 30°	LS3 □ M42D11 0 21° 37° 74° 21-22 13-14 30°	LS3 □ M51D11 0 21° 37° 74° 21-22 13-14 30°	LS3 □ M52D11 0 21° 37° 74° 21-22 13-14 30°	LS3 □ M91D11 0 14° 36° 21-22 13-14 21°
0.180	0.230	0.255	0.240	0.265	0.180

Special heads, accessories and special contact arrangement or particular function: please consult us.

Closed contact / Open contact

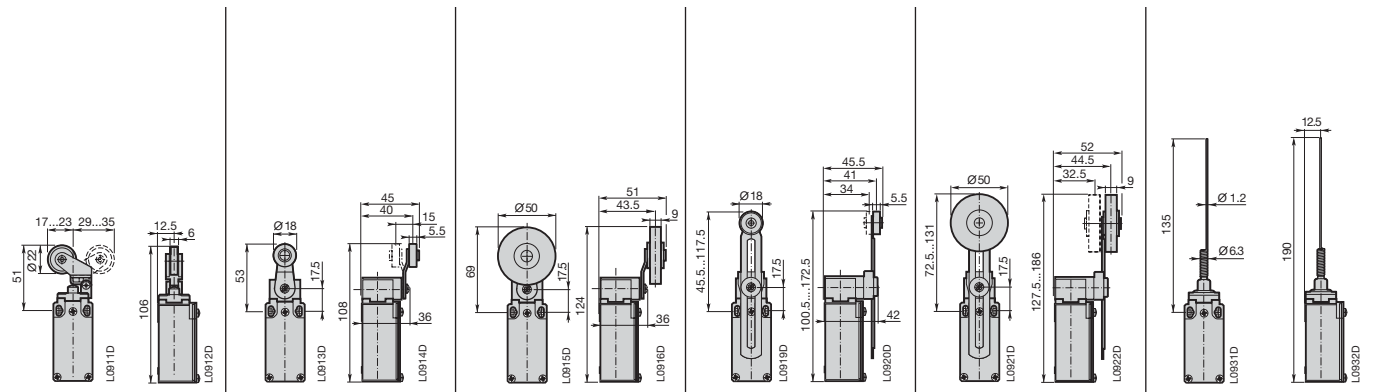

LS4..M.. Limit Switches

Metal Casing IP66 - 40 mm Width
1 Cable Inlet for Cable Gland

Movement to be detected:

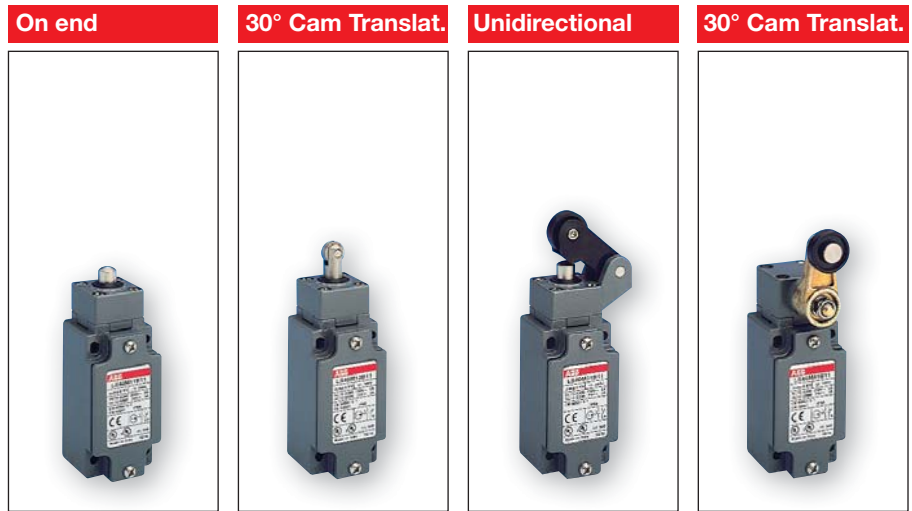

Actuator

	Stainless steel plunger	Ø12 stainless steel roller plunger	Ø22 plastic roller lever on stainless steel plunger	Ø22 plastic roller lever
Conformity / (N.C. contact with positive opening operation)	EN 50041 (B shape)	EN 50041 (C shape)	-	EN 50041 (A shape)
Maximum actuation speed	0.5 m/s	0.5 m/s	1.5 m/s	1.5 m/s
Min. force / torque: - actuation	30 N	22 N	12 N	0.15 N.m
- positive opening operation	45 N	40 N	40 N	0.30 N.m

Additional Technical Data

LS type code to be complete with the cable inlet code [0] = Pg 13.5
 [3] = M20 x 1.5
 [5] = 1/2" NPT

Snap action contacts	Type	LS4 □ M11B11	LS4 □ M13B11	LS4 □ M31B11	LS4 □ M41B11
	Operation diagram				
Non-overlapping Slow action contacts	Type	LS4 □ M11D11	LS4 □ M13D11	LS4 □ M31D11	LS4 □ M41D11
	Operation diagram				
Weight (packing per unit)	kg	0.240	0.240	0.275	0.280

Special heads, accessories and special contact arrangement or particular function: please consult us.

Closed contact / Open contact

Dimensions (mm)

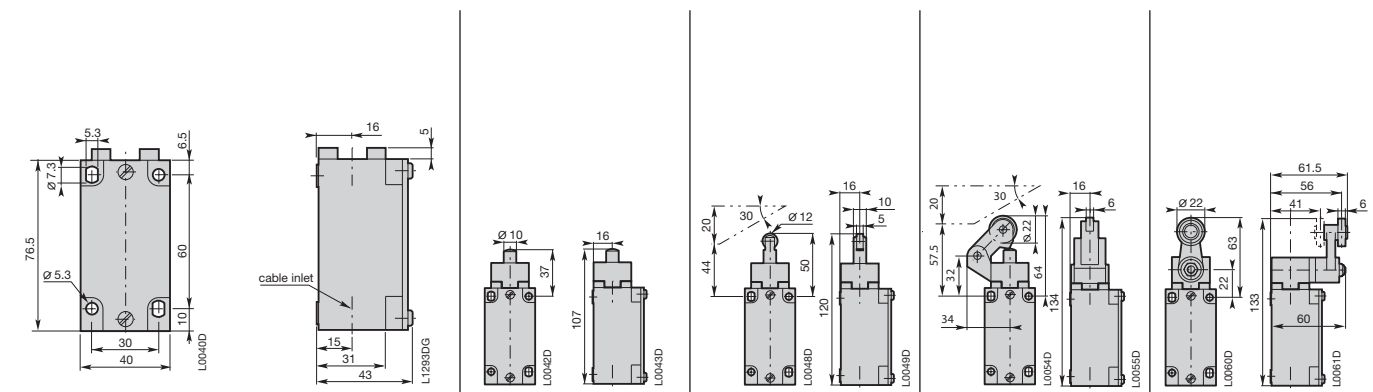

LS4..M.. Limit Switches

Metal Casing IP66 - 40 mm Width
1 Cable Inlet for Cable Gland

Movement to be detected:

30° Cam Translation Movement

Fully Direction Trans.

Multidirectional

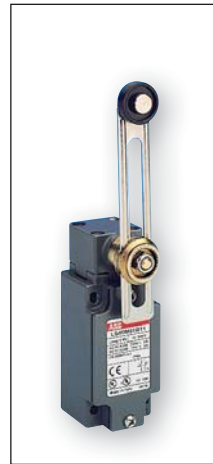

Actuator

	ø22 stainless steel roller lever	Adjustable ø22 plastic roller lever	Adjustable ø6 plastic rod lever	Spring rod
Conformity / (N.C. contact with positive opening operation)	EN 50041 (A shape)	-	EN 50041 (D shape)	-
Maximum actuation speed	1.5 m/s	1.5 m/s	1.5 m/s	1 m/s
Min. force / torque: - actuation	0.15 N.m	0.15 N.m	0.15 N.m	0.18 N.m
- positive opening operation	0.30 N.m	0.30 N.m	0.30 N.m	-

Additional Technical Data

LS type code to be complete with the cable inlet code [0] = Pg 13.5
[3] = M20 x 1.5
[5] = 1/2" NPT

Contacts	Type	LS4 □ M42B11	LS4 □ M51B11	LS4 □ M72B11	LS4 □ M91B11
Snap action contacts 	Operation diagram				
Non-overlapping Slow action contacts 	Operation diagram				
Weight (packing per unit)	kg	0.280	0.290	0.285	0.235

Special heads, accessories and special contact arrangement or particular function: please consult us.

Closed contact / Open contact

Dimensions (mm)

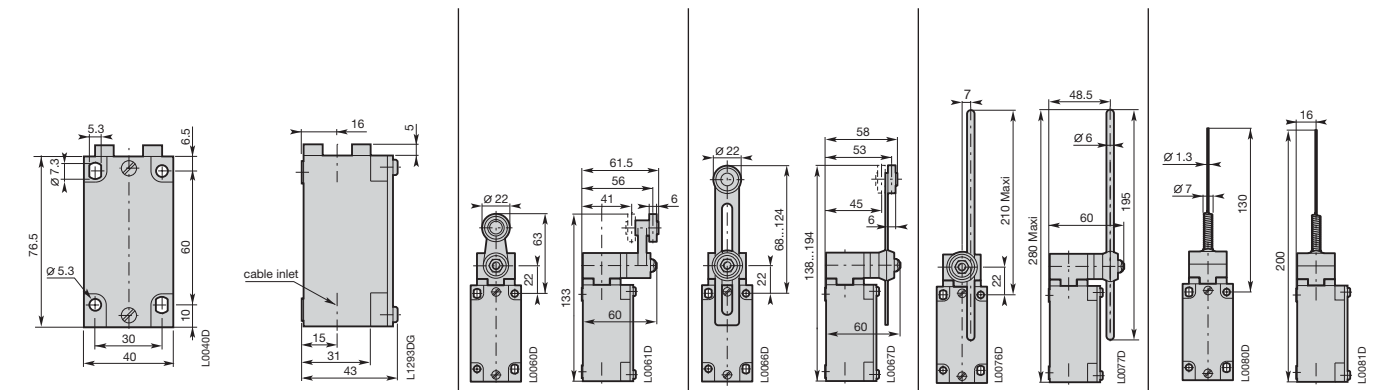

LS7..M.. Limit Switches

Metal Casing IP66 - 60 mm Width
3 Cable Inlets for Cable Gland

Movement to be detected:

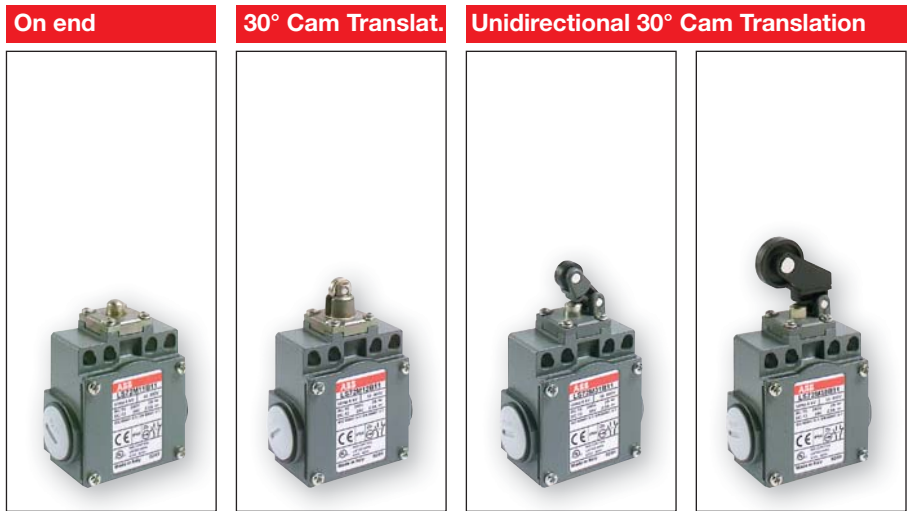

Actuator

	Metal plunger	Ø11 metal roller plunger	Ø12.5 plastic roller lever on steel plunger	Ø22 plastic roller lever on steel plunger
Conformity / (N.C. contact with positive opening operation)	-	-	-	-
Maximum actuation speed	0.5 m/s	0.3 m/s	1 m/s	1 m/s
Min. force / torque: - actuation	15 N	12 N	7 N	7 N
- positive opening operation	45 N	41 N	24 N	24 N

Additional Technical Data

LS type code to be complete with the cable inlet code
 0 = Pg 13.5
 1 = Pg 11
 2 = M16 x 1.5
 3 = M20 x 1.5
 5 = 1/2" NPT

Snap action contacts	Type	LS7 □ M11B11	LS7 □ M12B11	LS7 □ M31B11	LS7 □ M38B11
	Operation diagram				
Non-overlapping Slow action contacts	Type	LS7 □ M11D11	LS7 □ M12D11	LS7 □ M31D11	LS7 □ M38D11
	Operation diagram				
Weight (packing per unit)	kg	0.270	0.280	0.265	0.270

Special heads, accessories and special contact arrangement or particular function: please consult us.

Closed contact / Open contact

Dimensions (mm)

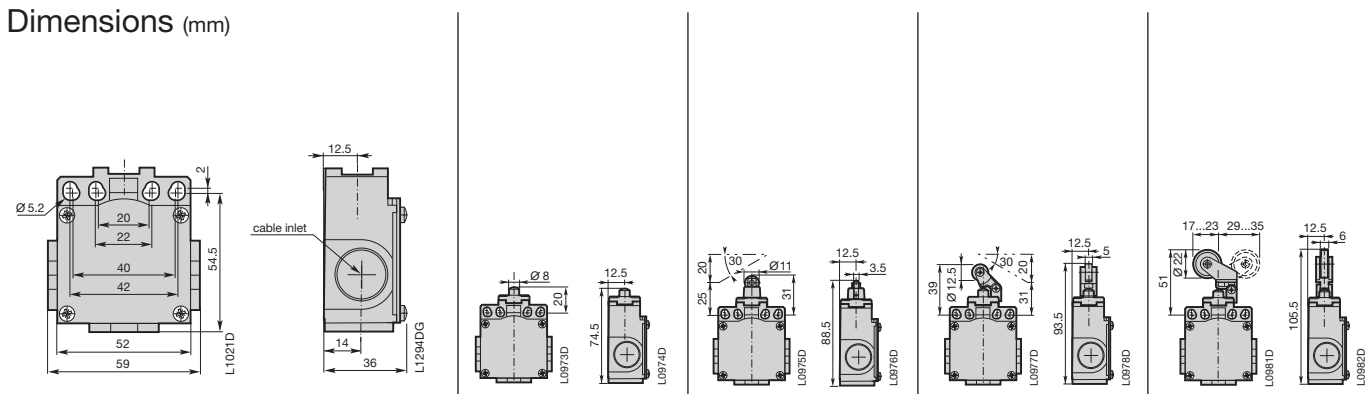

LS7..M.. Limit Switches

Metal Casing IP66 - 60 mm Width
3 Cable Inlets for Cable Gland

Movement to be detected:

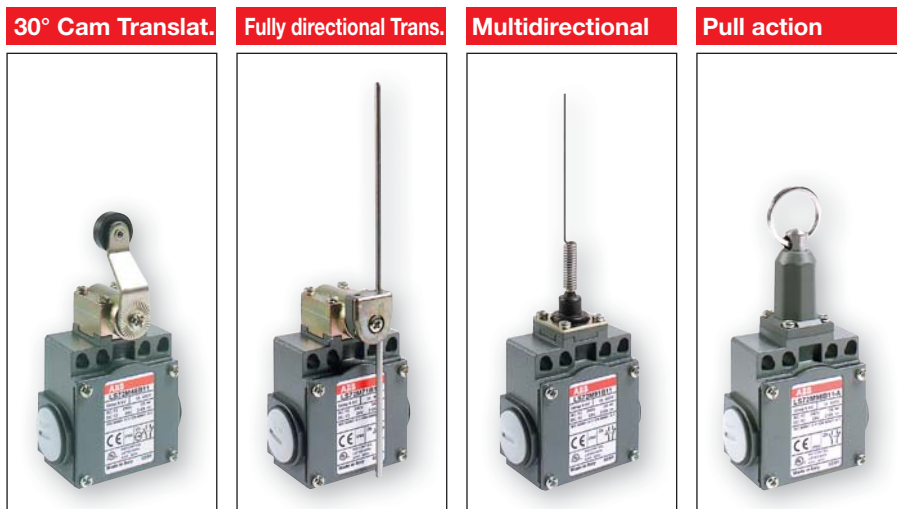

Actuator	ø18 plastic roller with bent lever	Adjustable ø3 stainless steel rod lever	Spring rod	Pull action with ring
Conformity / \rightarrow (N.C. contact with positive opening operation)	- \rightarrow	- \rightarrow	-	-
Maximum actuation speed	1.5 m/s	1.5 m/s	1 m/s	0.5 m/s
Min. force / torque: - actuation	0.1 N.m	0.1 N.m	0.12 N.m	30 N
- positive opening operation	0.32 N.m	0.32 N.m	-	-

Additional Technical Data

LS type code to be complete with the cable inlet code 0 = Pg 13.5

1 = Pg 11

2 = M16 x 1.5

3 = M20 x 1.5

5 = 1/2" NPT

Snap action contacts	Type	LS7 □ M45B11	LS7 □ M71B11	LS7 □ M91B11	LS7 □ M98B11-A
	Operation diagram				
Non-overlapping Slow action contacts	Type	LS7 □ M45D11	LS7 □ M71D11	LS7 □ M91D11	LS7 □ M98D11-A
	Operation diagram				
Weight (packing per unit)	kg	0.335	0.380	0.315	0.350

Special heads, accessories and special contact arrangement or particular function: please consult us.

Closed contact / Open contact

Dimensions (mm)

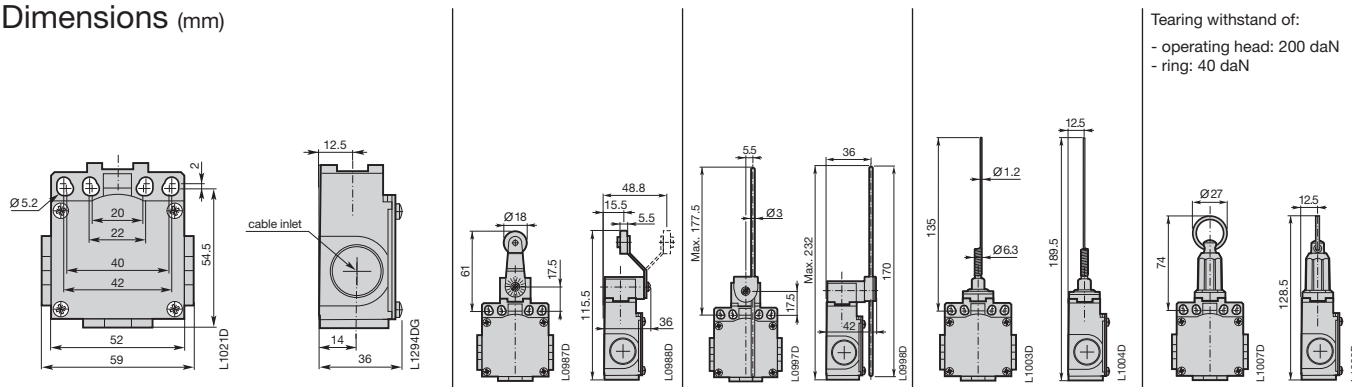

Tearing withstand of:
- operating head: 200 daN
- ring: 40 daN

Interrupteurs de position de sécurité - à languette (clé)

Double isolation - Boîtier plastique IP65 - Largeurs 30 et 40 mm
Boîtier métallique IP66 - Largeurs 30 et 40 mm

Applications

Simple d'emploi, les interrupteurs de position électromécaniques offrent des qualités spécifiques :

- Fonctionnement visible.
- Aptitude à la commutation des courants forts (courant thermique conventionnel 10 A).
- Ouverture assurée du ou des contacts "O" (N.C.) lorsque la languette est retirée de l'interrupteur.
- Blocs de contacts à manœuvre positive d'ouverture du contact ou des contacts à ouverture "O" (N.C.) (symbolisation ⊕).
- Séparation électrique des contacts.
- Précision sur les points de fonctionnement (fidélité).
- Immunité aux perturbations électromagnétiques.

Ces particularités en font les organes privilégiés pour le contrôle et la protection sur les machines industrielles sans inertie où le temps d'arrêt est inférieur au temps d'accès à la zone dangereuse. Utilisation sur protecteurs coulissants ou pivotants (capots, carter, portes, grilles, etc.).

- Ils contribuent à la protection de l'opérateur, intervenant sur une machine dangereuse, en ouvrant le circuit de commande. Le retrait de la languette (clé) par l'ouverture du protecteur mobile provoque l'arrêt immédiat de l'entraînement de la machine.
- Associés à d'autres interrupteurs de position standard et des dispositifs de commutation de sécurité, ils permettent de réaliser des circuits d'automatisme répondant à la norme EN 954-1.
- Ils respectent les exigences des Directives européennes (Basse Tension, Machines et Compatibilité Electromagnétique) et sont conformes aux normes européennes et internationales.

Description

Les interrupteurs de position de sécurité avec clé :

- **LS3..P..S** (largeur 30 mm) et **LS4..P..S** (largeur 40 mm), en matière thermoplastique UL-V0 renforcée de fibre de verre, offrent la double isolation  et un indice de protection IP65.
- **LS3..M..S** (largeur 30 mm), en alliage de zinc (zamack), offrent un indice de protection IP66.
- **LS4..M..S** (largeur 40 mm), en alliage d'aluminium, offrent un indice de protection IP66.

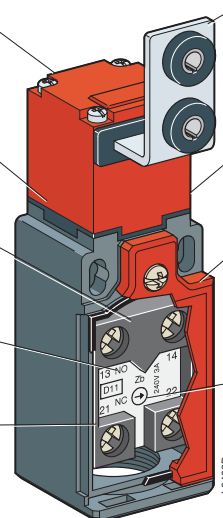

2 variantes de têtes de commande :

- Orientable tous les 90° par 4 vis ø3 pour (L3..P), par 4 vis ø4 pour (L4..P), par 4 vis M3 pour (L3..M) et par 4 vis M4 pour (L4..M)
- Pivotante de 0° à 360° avec 1 vis M3 (seulement LS3..P81 ou LS3..M81)

Boîtier :

- Largeur 30 mm avec dimensions normalisées du boîtier, correspondant à la norme EN 50047.
- Largeur 40 mm avec dimensions normalisées du boîtier, correspondant à la norme EN 50041.

Blocs de 2 ou 3 contacts :

- Configuration des contacts : 1 N.O. + 1 N.C., 2 N.C., 1 N.O. + 2 N.C. ou 3 N.C. (seulement LS4..P et LS4..M)
- Manoeuvre positive d'ouverture ⊕
- Action brusque (seulement pour les blocs de 2 contacts)
- Action dépendante
- Les deux contacts sont électriquement séparés

Bornes de raccordement :

- Vis M3,5 à tête (+,-) pozidriv 2 (Serre-fils solidaires des têtes de vis)
- Marquage conforme aux normes IEC 60947-1, IEC 60947-5-1, EN 50005 et EN 50013

Borne pour conducteur de protection, placée à proximité de l'entrée de câble et marquée : 

- Vis M3,5 à tête (+,-) pozidriv 2 (Serre-fils solidaire de la tête de vis)

7 variantes de languette (clé) (pour LS3..P ou LS3..M) et 5 variantes de languette (clé) (pour LS4..P ou LS4..M) à commander séparément :

- Clé coudée à angle droit (fixation 13 ou 22 mm)
- Clé droite (fixation 13 ou 22 mm)
- Clé droite ou coudée à angle droit avec amortisseur
- Clé coudée ajustable

Fixation du boîtier :

- 2 vis M4 en partie haute pour largeur 30 mm
- 2 ou 4 vis M5 pour largeur 40 mm

Couvercle :

- Fermeture par 1 vis ø3 pour LS3..P..S
- Fermeture par 3 vis M3 pour LS3..M..S
- Fermeture auto-blocante pour LS4..P..S
- Fermeture par 2 vis M4 pour LS4..M..S

Joint réalisé d'une seule pièce pour éviter les ruptures d'étanchéité

Raccordement électrique en différentes variantes :

- 1 entrée de câble (LS30P/M & LS40P/M) pour presse-étoupe Pg 13,5
- 1 entrée de câble (LS31P/M) pour presse-étoupe Pg 11
- 1 entrée de câble (LS32P/M) pour presse-étoupe ISO 16
- 1 entrée de câble (LS33P/M & LS43P/M) pour presse-étoupe ISO 20
- 1 entrée de câble (LS35P) par adaptateur plastique 1/2" NPT
- 1 entrée de câble (LS35M & LS45P/M) pour presse-étoupe 1/2" NPT

Approprié pour raccordement par conduit direct mais seulement avec l'utilisation d'un adaptateur facultativement fourni par le fabricant (sur demande)

Type

Exemple : **L S 3 1 P 8 0 D 1 1 - S**

Interrupteur de position (Limit Switch)	LS
Largeur de boîtier : 30 mm	3
1 entrée de câble pour presse-étoupe Pg 13,5	0
1 entrée de câble pour presse-étoupe Pg 11	1
1 entrée de câble M16 x 1,5 pour presse-étoupe ISO 16	2
1 entrée de câble M20 x 1,5 pour presse-étoupe ISO 20	3
1 entrée de câble par adaptateur plastique 1/2" NPT pour (LS35P) ou 1/2" NPT pour presse-étoupe (LS35M)	5
Largeur de boîtier : 40 mm	4
1 entrée de câble pour presse-étoupe Pg 13,5	0
1 entrée de câble pour presse-étoupe ISO 20	3
1 entrée de câble pour presse-étoupe 1/2" NPT	5
Boîtier Plastique	P
Boîtier Métallique	M

SAppareil de Sécurité

Types de contacts :

- 11** 1 contact N.O. + 1 contact N.C.
- 12** 1 contact N.O. + 2 contacts N.C. (pour LS4..P.. ou LS4..M..)
- 02** 2 contacts N.C.
- 03** 3 contacts N.C. (pour LS4..P.. ou LS4..M..)

Action brusque :

- B**Zb Brusque

Action dépendante (lent) :

- L**Lent / Simultané (pour 1 N.O. + 1 N.C. et 2 N.C. uniquement)
- D**Zb Décalé à action retardée
- C**Zb Chevauchant à fermeture avancée (pour 1 N.O. + 1 N.C. uniquement)

Têtes de commande (voir le panorama)

- 80**Orientable tous les 90°
- 81**Pivotante de 0° à 360° (seulement pour LS3..P & LS3..M)

Interrupteurs de position de sécurité - avec axe ou levier

Double isolation - Boîtier plastique IP65 - Largeur 30 mm
Boîtier métallique IP66 - Largeur 30 mm

Applications

Simple d'emploi, les interrupteurs de position avec axe rotatif ou levier offrent des qualités spécifiques :

- Fonctionnement visible.
- Aptitude à la commutation des courants forts (courant thermique conventionnel 10 A).
- Ouverture des contacts "O" (N.C.) pour un angle de rotation très faible : 7°.
- Blocs de contacts à manoeuvre positive d'ouverture du ou des contacts "O" (N.C.) (symbolisation ⊕).
- Séparation électrique des contacts.
- Précision sur les points de fonctionnement (fidélité).
- Immunité aux perturbations électromagnétiques.

Ces particularités en font les organes privilégiés pour le contrôle et la protection sur des machines industrielles légères sans inertie équipées de protecteurs à mouvement angulaire (portes, grilles à charnières, capots ou carter rotatifs, etc.). Détection par l'axe de rotation ou par l'intermédiaire d'un levier .

- L'ouverture du protecteur mobile assure la protection de l'opérateur, par l'arrêt immédiat de l'entraînement de la machine.
- Ils sont parfaitement appropriés pour la mise en conformité du parc machines existant, car ils peuvent se monter sur les dispositifs de protection déjà installés.
- Associés à d'autres interrupteurs de position standard et des dispositifs de commutation de sécurité, ils permettent de réaliser des circuits d'automatismes correspondant à la norme EN 954-1.
- Ils respectent les exigences des Directives européennes (Basse Tension, Machines et Compatibilité Electromagnétique) et sont conformes aux normes européennes et internationales.

Description

LS3..P75..-S à LS3..P77..-S, interrupteurs de position de sécurité en matière thermoplastique UL-V0 renforcée de fibre de verre, offrent la double isolation □ et un indice de protection IP65.

LS3..M75..-S à LS3..M77..-S, interrupteurs de position de sécurité en alliage de zing (zamack), offrent un indice de protection IP66.

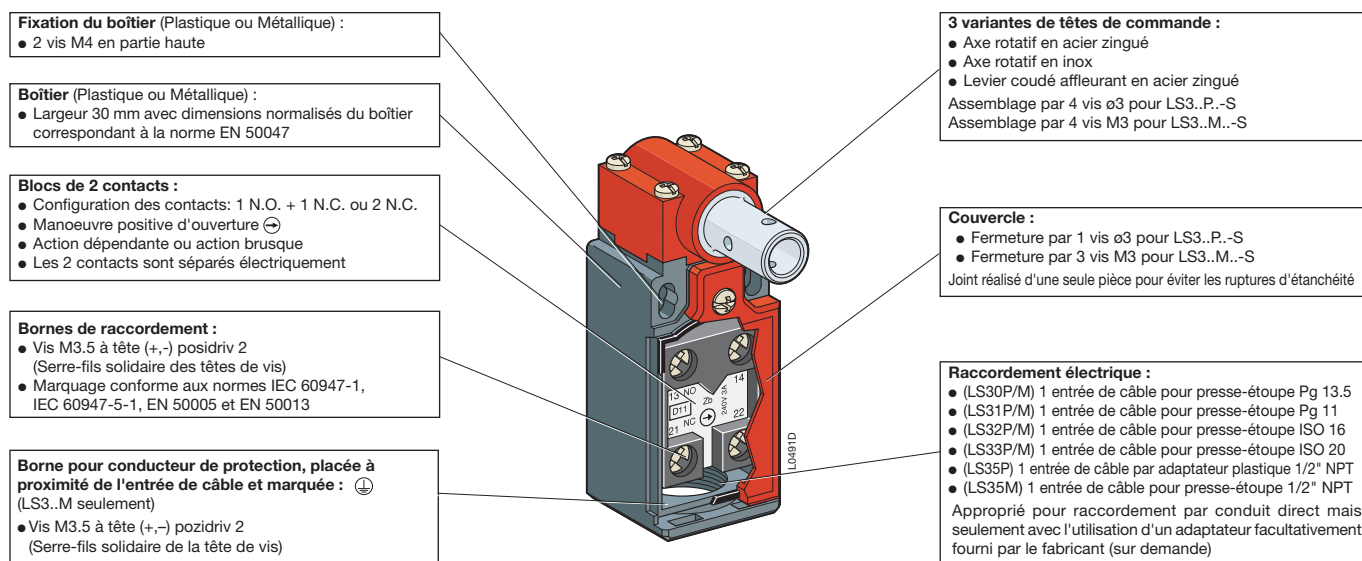

Type

Exemple : **LS 31 P 75 D 11 - S**

Interrupteur de position (Limit Switch)	LS	S	Appareil de Sécurité
Largeur de boîtier : 30 mm	3	11	1 contact N.O. + 1 contact N.C.
1 entrée de câble pour presse-étoupe Pg 13.5	0	02	2 contacts N.C.
1 entrée de câble pour presse-étoupe Pg 11	1		
1 entrée de câble M16 x 1.5 pour presse-étoupe ISO 16	2		
1 entrée de câble M20 x 1.5 pour presse-étoupe ISO 20	3		
1 entrée de câble par adaptateur plastique 1/2" NPT (LS35P) ou pour presse-étoupe 1/2" NPT (LS35M)	5		
Boîtier Plastique.....	P		
Boîtier Métallique.....	M		
Têtes de commande :			
Axe rotatif en acier zingué	75		
Axe rotatif en inox.....	76		
Levier coudé affleurant en acier zingué	77		
Action brusque :			
B	Zb		Brusque
Action dépendante (lent) :			
L	Lent / Simultané		
D	Zb Décalé à fermeture retardée		
C	Zb Chevauchant à fermeture avancée		

Interrupteurs de position de sécurité - commande par câble

Double isolation - Boîtier plastique IP65 - Largeur 30 mm
Boîtier métallique IP66 - Largeurs 30, 40 et 60 mm

Applications

Simple d'emploi, les interrupteurs de position de sécurité à commande par câble pour arrêt d'urgence avec accrochage et réarmement manuel offrent des qualités spécifiques :

- Aptitude à la commutation des courants forts (courant thermique conventionnel 10 A).
- Blocs de contacts à manœuvre positive d'ouverture du contact ou des contacts à ouverture "O" (N.C.) (symbolisation ⊕).
- Séparation électrique des contacts.
- Précision sur les points de fonctionnement (fidélité).
- Immunité aux perturbations électromagnétiques.

Ces particularités en font les organes privilégiés pour le contrôle et la protection dans des lieux techniques (laboratoires d'essais, lignes de peinture,...) et sur les machines industrielles (presses, bandes transporteuses, machines de transferts,...) pouvant présenter des risques ou des phénomènes dangereux en fonctionnement.

En tout point de sa zone de travail, l'opérateur doit pouvoir actionner (tirer) facilement le câble pour commander l'ordre d'arrêt de la machine ou le travail en cours.

- Associés à des interrupteurs de position et des dispositifs de commutation de sécurité, ils permettent de réaliser des circuits d'automatisme répondant à la norme EN 954-1.
- Ils respectent les exigences des Directives européennes (Basse Tension, Machines et Compatibilité Electromagnétique) et sont conformes aux normes européennes et internationales.

Description

Interrupteurs de position de sécurité à commande par câble pour arrêt d'urgence avec accrochage et réarmement manuel :

LS3..P.-SCR (largeur 30 mm), en matière thermoplastique UL-V0 renforcée de fibre de verre, offrent la double isolation  et un indice de protection IP65.

LS3..M.-SCR (largeur 30 mm), en alliage de zinc (zamack), offrent un indice de protection IP66.

LS4..M.-SCR (largeur 40 mm) et **LS6..M.-SCR** (largeur 60 mm), en alliage d'aluminium, offrent un indice de protection IP66.



Bouton bleu de réarmement manuel

Boîtier :

- Largeur 30 mm avec dimensions normalisées du boîtier, correspondant à la norme EN 50047
- Largeur 40 mm avec dimensions normalisées du boîtier, correspondant à la norme EN 50041
- Largeur 60 mm

Blocs de 2 ou 3 contacts :

- Configuration des contacts : 1 N.O. + 1 N.C., 2 N.C., 1 N.O. + 2 N.C. or 3 N.C. (seulement LS4..M.-SCR & LS6..M.-SCR)
- Manœuvre positive d'ouverture ⊕
- Action brusque (seulement pour les blocs de 2 contacts)
- Action dépendante
- Les deux contacts sont électriquement séparés

Bornes de raccordement :

- Vis M3.5 à tête (+,-) pozidriv 2 (Serre-fils solidaires des têtes de vis)
- Marquage conforme aux normes IEC 60947-1, IEC 60947-5-1, EN 50005 et EN 50013

Borne pour conducteur de protection, placée à proximité de l'entrée de câble et marquée : ⊕ (LS3..M.-SCR, LS4..M.-SCR & LS6..M.-SCR seulement)

- Vis M3.5 à tête (+,-) pozidriv 2 (Serre-fils solidaire de la tête de vis)

Têtes de commande :

- Assemblage par 4 vis M3 pour LS3..M
- Assemblage par 4 vis ø 3 pour LS3..P
- Assemblage par 4 vis M4 pour largeurs 40 & 60 mm

Fixation du boîtier :

- 2 vis M4 en partie haute pour largeur 30 mm
- 2 ou 4 vis M5 pour largeur 40 mm
- 2 vis M5 en partie haute pour largeur 60 mm

Couvercle :

- Fermeture par 1 vis ø 3 pour LS3..P.-SCR
- Fermeture par 3 vis M3 pour LS3..M.-SCR
- Fermeture par 2 vis M4 pour LS4..M.-SCR
- Fermeture par 4 vis M4 pour LS6..M.-SCR

Joint réalisé d'une seule pièce pour éviter les ruptures d'étanchéité

Raccordement électrique :

- * entrée de câble (LS30P/M, LS40M & LS60M) pour presse-étoupe Pg 13.5
- 1 entrée de câble (LS31P/M) pour presse-étoupe Pg 11
- 1 entrée de câble (LS32P/M) pour presse-étoupe ISO 16
- * entrée de câble (LS33P/M, LS43M & LS63M) pour presse-étoupe ISO 20
- 1 entrée de câble (LS35P) par adaptateur plastique 1/2" NPT
- * entrée de câble (LS35M, LS45M & LS65M) pour presse-étoupe 1/2" NPT

* 1 entrée de câble (LS3P/M & LS4M) & 3 entrées de câble (LS6M) Approprié pour raccordement par conduit direct mais seulement avec l'utilisation d'un adaptateur facultativement fourni par le fabricant (sur demande)

Type

Exemple :

L	S	3	1	P	9	8	D	1	1	-	SCR
L	S			P						-	SCR

<p>Interrupteur de position (Limit Switch)LS</p> <p>Largeur de boîtier : 30 mm3</p> <p>1 entrée de câble pour presse-étoupe Pg 13.50</p> <p>1 entrée de câble pour presse-étoupe Pg 111</p> <p>1 entrée de câble M16 x 1.5 pour presse-étoupe ISO 162</p> <p>1 entrée de câble M20 x 1.5 pour presse-étoupe ISO 203</p> <p>1 entrée de câble par adaptateur plastique 1/2" NPT pour (LS35P) ou 1/2" NPT pour presse-étoupe (LS35M)5</p> <p>Largeur de boîtier : 40 mm4</p> <p>Largeur de boîtier : 60 mm6</p> <p>1 entrée de câble (LS40M) ou 3 (LS60M) pour presse-étoupe Pg 13.50</p> <p>1 entrée de câble (LS43M) ou 3 (LS63M) pour presse-étoupe ISO 203</p> <p>1 entrée de câble (LS45M) ou 3 (LS65M) pour presse-étoupe 1/2" NPT5</p> <p>Boîtier Plastique.....P</p> <p>Boîtier Métallique.....M</p>	<p>SCR Appareil de Sécurité avec anneau</p> <p>Types de contacts :</p> <p>11 1 contact N.O. + 1 contact N.C.</p> <p>12 1 contact N.O. + 2 contacts N.C. (pour LS4..M.. ou LS6..M..)</p> <p>02 2 contacts N.C.</p> <p>03 3 contacts N.C. (pour LS4..M.. ou LS6..M..)</p> <p>Action brusque :</p> <p>BZb Brusque (pour 1 N.O. + 1 N.C. et 2 N.C. uniquement)</p> <p>Action dépendante (lent) :</p> <p>LLent / Simultané</p> <p>DZb Décalé à action retardée</p> <p>CZb Chevauchant à fermeture avancée (pour 1 N.O. + 1 N.C. uniquement)</p> <p>Têtes de commande :</p> <p>98avec anneau</p>
--	--

Interrupteurs de position de sécurité - à languette (clé)

Boîtier plastique IP65 □ - Largeurs 30 mm et 40 mm

Boîtier métallique IP66 - Largeurs 30 mm et 40 mm



LS30P80D11-S



LS32M80D11-S



LS40P80D12-S



LS40M80D12-S



LSA30P08

LS30P : 1 entrée de câble pour presse-étoupe Pg 13.5	0	0 2
LS31P : 1 entrée de câble pour presse-étoupe Pg 11	1	0 1
LS32P : 1 entrée de câble pour presse-étoupe ISO 16	2	0 3
LS33P : 1 entrée de câble pour presse-étoupe ISO 20	3	2 2
LS35P : 1 entrée de câble par adaptateur plastique 1/2" NPT	5	2 1
LS30M : 1 entrée de câble pour presse-étoupe Pg 13.5	0	1 8
LS31M : 1 entrée de câble pour presse-étoupe Pg 11	1	1 7
LS32M : 1 entrée de câble pour presse-étoupe ISO 16	2	1 9
LS33M : 1 entrée de câble pour presse-étoupe ISO 20	3	3 8
LS35M : 1 entrée de câble pour presse-étoupe 1/2" NPT	5	3 7

Boîtier plastique - 30 mm
IP65 □

Boîtier métallique - 30 mm
IP66

Références de commande - Produit sans languette (clé)

Blocs de contacts	Type	Réf. Commerciale	Masse kg (1)
 D11	 L02	code entrée de câble □	Cond ^{mt} 1 pièce

Boîtier plastique avec tête orientable tous les 90°

1	-	LS3 □ P80D11-S	1SBV03 □ □ 80R1411	0.080
-	1	LS3 □ P80L02-S	1SBV03 □ □ 80R1302	0.080

Boîtier métallique avec tête orientable tous les 90°

1	-	LS3 □ M80D11-S	1SBV03 □ □ 80R1411	0.180
-	1	LS3 □ M80L02-S	1SBV03 □ □ 80R1302	0.180

(1) Pour LS35P ajouter 0.007 kg.

LS40P : 1 entrée de câble pour presse-étoupe Pg 13.5	0	0 5
LS43P : 1 entrée de câble pour presse-étoupe ISO 20	3	0 7
LS45P : 1 entrée de câble pour presse-étoupe 1/2" NPT	5	2 4

Boîtier plastique - 40 mm
IP65 □

Boîtier métallique - 40 mm
IP66

Références de commande - Produit sans languette (clé)

Blocs de contacts	Type	Réf. Commerciale	Masse kg
 D12	 L03	code entrée de câble □	Cond ^{mt} 1 pièce

Boîtier plastique avec tête orientable tous les 90°

1	-	LS4 □ P80D12-S	1SBV03 □ □ 80R1412	0.155
-	1	LS4 □ P80L03-S	1SBV03 □ □ 80R1303	0.155

Boîtier métallique avec tête orientable tous les 90°

1	-	LS4 □ M80D12-S	1SBV03 □ □ 80R1412	0.210
-	1	LS4 □ M80L03-S	1SBV03 □ □ 80R1303	0.210

Références de commande - Languettes (Clés)

Description de la clé	Fixation mm	Type	Réf. Commerciale	Masse kg Pack th 1 pièce
-----------------------	-------------	------	------------------	--

Languette (clé) pour LS3..P.. ou LS3..M..

Coudée à angle droit	13	LSA30P05	1SBV 048 605 R1000	0.011
Droite	13	LSA30P06	1SBV 048 606 R1000	0.011
Coudée à angle droit avec amortisseur	15	LSA30P07	1SBV 048 607 R1000	0.014
Droite avec amortisseur	15	LSA30P08	1SBV 048 608 R1000	0.014
Coudée ajustable	40	LSA30P09	1SBV 048 609 R1000	0.022

Languette (clé) pour LS4..P.. ou LS4..M..

Coudée à angle droit	13	LSA40X05	1SBV 048 805 R1000	0.014
Droite	13	LSA40X06	1SBV 048 806 R1000	0.014
Coudée à angle droit avec amortisseur	15	LSA40X07	1SBV 048 807 R1000	0.017
Droite avec amortisseur	15	LSA40X08	1SBV 048 808 R1000	0.017
Coudée ajustable	40	LSA40X09	1SBV 048 809 R1000	0.025

Interrupteurs de position de sécurité - avec axe ou levier

Double Isolation - Boîtier plastique IP65 - Largeur 30 mm

Boîtier métallique IP66 - Largeur 30 mm



LS30P75D11-S



LS32M76D11-S



LS30P77D11-S

LS30P : 1 entrée de câble pour presse-étoupe Pg 13.5	0	0 2
LS31P : 1 entrée de câble pour presse-étoupe Pg 11	1	0 1
LS32P : 1 entrée de câble pour presse-étoupe ISO 16	2	0 3
LS33P : 1 entrée de câble pour presse-étoupe ISO 20	3	2 2
LS35P : 1 entrée de câble par adaptateur plastique 1/2" NPT ..	5	2 1

Boîtier plastique - 30 mm
IP65

LS30M : 1 entrée de câble pour presse-étoupe Pg 13.5	0	1 8
LS31M : 1 entrée de câble pour presse-étoupe Pg 11	1	1 7
LS32M : 1 entrée de câble pour presse-étoupe ISO 16	2	1 9
LS33M : 1 entrée de câble pour presse-étoupe ISO 20	3	3 8
LS35M : 1 entrée de câble pour presse-étoupe 1/2" NPT	5	3 7

Boîtier métallique - 30 mm
IP66

Références de commande

Blocs de contacts	Type	Réf. Commerciale	Masse kg (1)
<p>D11</p>	code entrée de câble <input type="checkbox"/>	<p>L02</p>	Cond ^{mt} 1 pièce

Boîtier plastique avec axe rotatif (zingué)

1	-	LS3 <input type="checkbox"/> P75D11-S	1SBV03 <input type="checkbox"/> <input type="checkbox"/> 75R1411	0.090
-	1	LS3 <input type="checkbox"/> P75L02-S	1SBV03 <input type="checkbox"/> <input type="checkbox"/> 75R1302	0.090

Boîtier plastique avec axe rotatif en inox

1	-	LS3 <input type="checkbox"/> P76D11-S	1SBV03 <input type="checkbox"/> <input type="checkbox"/> 76R1411	0.090
-	1	LS3 <input type="checkbox"/> P76L02-S	1SBV03 <input type="checkbox"/> <input type="checkbox"/> 76R1302	0.090

Boîtier métallique avec axe rotatif (zingué)

1	-	LS3 <input type="checkbox"/> M75D11-S	1SBV03 <input type="checkbox"/> <input type="checkbox"/> 75R1411	0.190
-	1	LS3 <input type="checkbox"/> M75L02-S	1SBV03 <input type="checkbox"/> <input type="checkbox"/> 75R1302	0.190

Boîtier métallique avec axe rotatif en inox

1	-	LS3 <input type="checkbox"/> M76D11-S	1SBV03 <input type="checkbox"/> <input type="checkbox"/> 76R1411	0.190
-	1	LS3 <input type="checkbox"/> M76L02-S	1SBV03 <input type="checkbox"/> <input type="checkbox"/> 76R1302	0.190

Boîtier plastique avec levier (zingué)

1	-	LS3 <input type="checkbox"/> P77D11-S	1SBV03 <input type="checkbox"/> <input type="checkbox"/> 77R1411	0.110
-	1	LS3 <input type="checkbox"/> P77L02-S	1SBV03 <input type="checkbox"/> <input type="checkbox"/> 77R1302	0.110

Boîtier métallique avec levier (zingué)

1	-	LS3 <input type="checkbox"/> M77D11-S	1SBV03 <input type="checkbox"/> <input type="checkbox"/> 77R1411	0.210
-	1	LS3 <input type="checkbox"/> M77L02-S	1SBV03 <input type="checkbox"/> <input type="checkbox"/> 77R1302	0.210

(1) Pour LS 35P ajouter 0.007 kg.

Interrupteurs de position de sécurité - commande par câble

Double isolation - Boîtier plastique IP65 - Largeur 30 mm
Boîtier métallique IP66 - Largeurs 30, 40 et 60 mm



LS32M98D11-SCR



LS40M98D11-SCR



LS60M98D12-SCR



LSR5242



LSR5343



LSR5444



LSR5551

LS30P : 1 entrée de câble pour presse-étoupe Pg 13.5.....	0	0	2
LS31P : 1 entrée de câble pour presse-étoupe Pg 11.....	1	0	1
LS32P : 1 entrée de câble pour presse-étoupe ISO 16.....	2	0	3
LS33P : 1 entrée de câble pour presse-étoupe ISO 20.....	3	2	2
LS35P : 1 entrée de câble par adaptateur plastique 1/2" NPT ..	5	2	1
LS30M : 1 entrée de câble pour presse-étoupe Pg 13.5.....	0	1	8
LS31M : 1 entrée de câble pour presse-étoupe Pg 11.....	1	1	7
LS32M : 1 entrée de câble pour presse-étoupe ISO 16.....	2	1	9
LS33M : 1 entrée de câble pour presse-étoupe ISO 20.....	3	3	8
LS35M : 1 entrée de câble pour presse-étoupe 1/2" NPT.....	5	3	7

Boîtier plastique - 30 mm
IP65

Boîtier métallique - 30 mm
IP66

Blocs de contacts	Type	Réf. Commerciale	Masse kg (1)
 D11	 L02	code entrée de câble <input type="checkbox"/>	code entrée de câble <input type="checkbox"/> <input type="checkbox"/>
			Cond ^{mt} 1 pièce

Boîtier plastique - Commande par câble pour arrêt d'urgence avec accrochage et réarmement manuel

1	-	LS3 <input type="checkbox"/> P98D11-SCR	1SBV03 <input type="checkbox"/> <input type="checkbox"/> 98R1411	0.115
-	1	LS3 <input type="checkbox"/> P98L02-SCR	1SBV03 <input type="checkbox"/> <input type="checkbox"/> 98R1302	0.115

Boîtier métallique - Commande par câble pour arrêt d'urgence avec accrochage et réarmement manuel

1	-	LS3 <input type="checkbox"/> M98D11-SCR	1SBV03 <input type="checkbox"/> <input type="checkbox"/> 98R1411	0.270
-	1	LS3 <input type="checkbox"/> M98L02-SCR	1SBV03 <input type="checkbox"/> <input type="checkbox"/> 98R1302	0.270

(1) pour LS 35P ajouter 0.007 kg.

LS40M : 1 entrée de câble pour presse-étoupe Pg 13.5.....	0	1	1
LS43M : 1 entrée de câble pour presse-étoupe ISO 20.....	1	1	6
LS45M : 1 entrée de câble pour presse-étoupe 1/2" NPT.....	2	3	1
LS60M : 3 entrées de câble pour presse-étoupe Pg 13.5.....	0	1	3
LS63M : 3 entrées de câble pour presse-étoupe ISO 20.....	1	1	5
LS65M : 3 entrées de câble pour presse-étoupe 1/2" NPT.....	2	3	3

Boîtier métallique - 40 mm
IP66

Boîtier métallique - 60 mm
IP66

Blocs de contacts	Type	Réf. Commerciale	Masse kg
 D12	 L03	code entrée de câble <input type="checkbox"/>	code entrée de câble <input type="checkbox"/> <input type="checkbox"/>
			Cond ^{mt} 1 pièce

Boîtier plastique - Commande par câble pour arrêt d'urgence avec accrochage et réarmement manuel

1	-	LS4 <input type="checkbox"/> M98D12-SCR	1SBV03 <input type="checkbox"/> <input type="checkbox"/> 98R1412	0.270
-	1	LS4 <input type="checkbox"/> M98L03-SCR	1SBV03 <input type="checkbox"/> <input type="checkbox"/> 98R1303	0.270

Boîtier métallique - Commande par câble pour arrêt d'urgence avec accrochage et réarmement manuel

1	-	LS6 <input type="checkbox"/> M98D12-SCR	1SBV03 <input type="checkbox"/> <input type="checkbox"/> 98R1412	0.300
-	1	LS6 <input type="checkbox"/> M98L03-SCR	1SBV03 <input type="checkbox"/> <input type="checkbox"/> 98R1303	0.300

Accessoires

Description des accessoires	Type	Réf. Commerciale	Masse kg	
Serre-câble D5	LSR5242	1SBV 047 800 R5242	0.060	
Renfort de boucle D5	LSR5343	1SBV 047 800 R5343	0.005	
Support de câble M8 x 59	LSR5444	1SBV 047 800 R5444	0.080	
Ridoir (tendeur) M6	LSR5141	1SBV 047 800 R5141	0.080	
Ressort d'extrémité (LS3...P, LS3...M)	LSR5845	1SBV 047 800 R5845	0.050	
Ressort d'extrémité (LS4...M, LS6...M)	LSR5846	1SBV 047 800 R5846	0.050	
Câble rouge D5 longueur	10.50 mètres	LSR5547	1SBV 047 800 R5547	0.580
	15.50 mètres	LSR5548	1SBV 047 800 R5548	0.860
	25.50 mètres	LSR5549	1SBV 047 800 R5549	1.410
	51.00 mètres	LSR5550	1SBV 047 800 R5550	2.790
	102.00 mètres	LSR5551	1SBV 047 800 R5551	5.600

Interrupteurs de position de sécurité à languette (clé) ou avec axe ou levier

Courses et diagrammes de fonctionnement

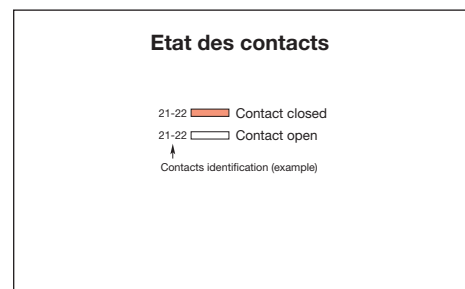
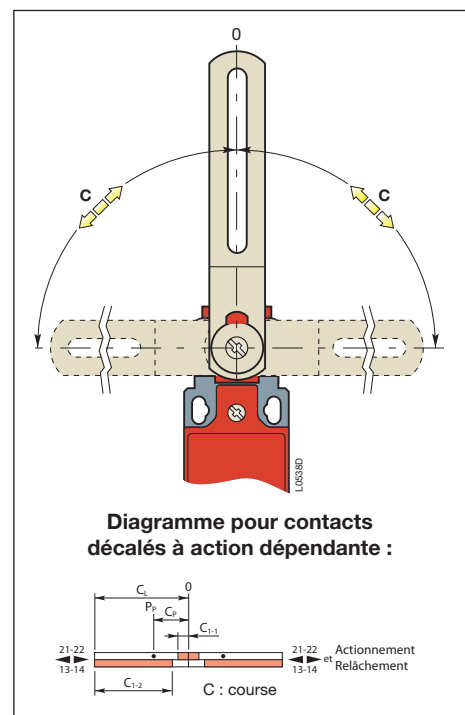
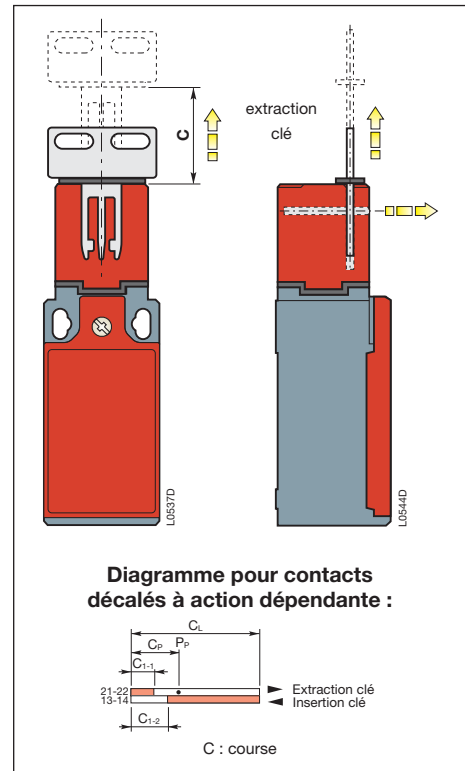
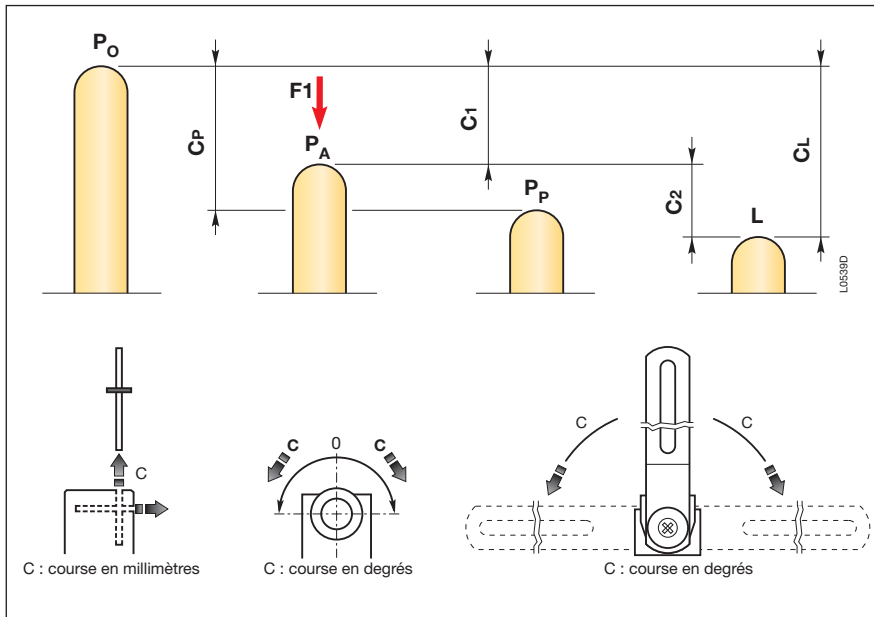

P_o Position de repos : position de l'organe de commande lorsque aucune force extérieure ne lui est appliquée.

P_A Point d'action : position de l'organe de commande, sous l'action de la force F_1 , au moment où les contacts quittent leur état initial de repos.

P_P Point d'ouverture positive : position de l'organe de commande à partir de laquelle l'ouverture positive est assurée.

L Limite de fin de course : Position limite acceptable de l'organe de commande sous l'action d'une force F_1 .

C₁ Course d'approche (course moyenne) : distance entre la position repos P_o et le point d'action P_A .

C_P Course d'ouverture positive : déplacement minimum de l'organe de commande, depuis la position de repos, pour assurer la manœuvre positive d'ouverture du contact à ouverture (N.C.).

C₂ Course résiduelle (course moyenne) : distance entre le point d'action P_A et la limite de fin de course L .

C_L Course limite (course maximale) : distance entre la position de repos P_o et la limite de fin de course L .

Note: C_{1-1} = course d'approche du contact 21-22,
 C_{1-2} = course d'approche du contact 13-14.

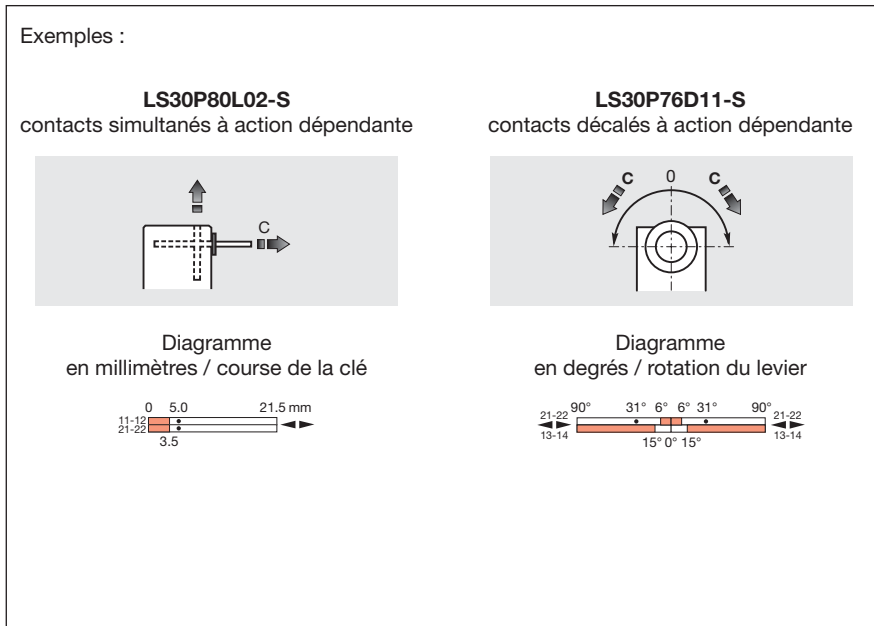

Interrupteurs de position de sécurité à commande par câble pour arrêt d'urgence

Courses et diagrammes de fonctionnement et installation

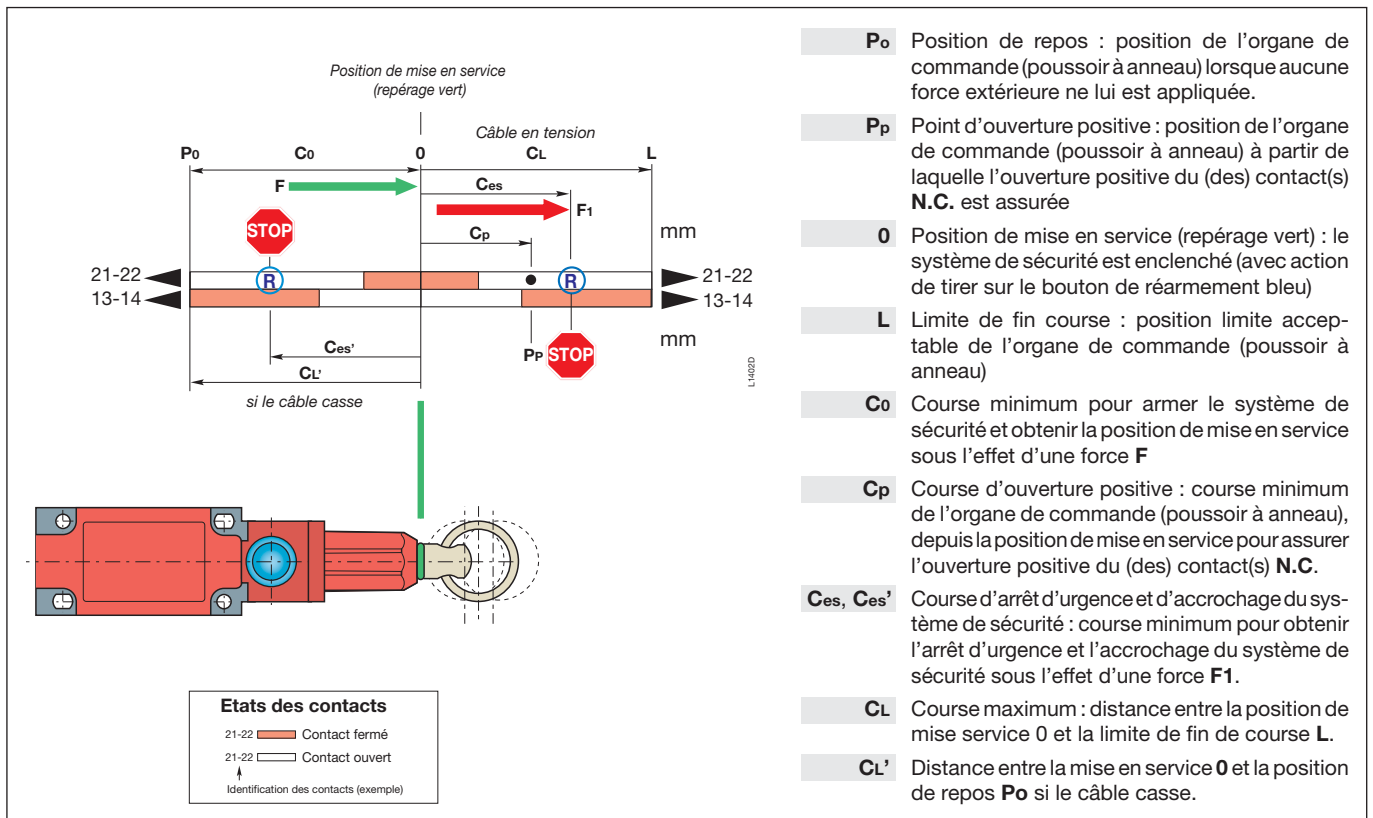

Installation

Pour obtenir le fonctionnement correct de l'appareil, merci de suivre les instructions suivantes :

- Selon l'emplacement de l'appareil, si nécessaire, tourner la tête en dévissant les 4 vis de fixation afin que le bouton bleu de réarmement soit accessible. Une fois la tête positionnée, revissez les 4 vis avec un couple de serrage de 0,8 Nm.
- Fixez solidement l'appareil et les supports de câble sur des éléments rigides afin que le câble soit bien guidé. Insérer du côté de l'appareil un ridoir et de l'autre côté du câble un ressort d'extrémité. Tendre le câble à l'aide du ridoir jusqu'à faire apparaître sur le poussoir métallique la marque verte en bout de la partie rouge de la tête. (fig.1)
- Tirez le bouton de réarmement bleu pour armer le système de sécurité et fermer les contacts de sécurité.
- Les contacts à l'intérieur de l'interrupteur de position changeront d'état chaque fois que le câble aura été sollicité (par traction) comme montré dans le diagramme ci-dessus.
- Vérifiez que l'appareil fonctionne correctement avant de mettre en marche la machine, en faisant les tests ci-dessous :
 - tirer doucement sur le câble, le bouton de réarmement bleu ne change pas de position mais le contact **N.C.** s'ouvre et commande l'arrêt "normal" de la machine.
 - tirer sur le câble avec une force **F1**, le bouton de réarmement bleu change de position et commande l'arrêt d'urgence de la machine avec accrochage du système de sécurité.
 - pour remettre la machine en fonctionnement revenez au point N° 2 et répéter l'opération (si nécessaire).
- L'utilisation de ces appareils implique le respect des normes : EN 1088, EN 292, EN 954-1.

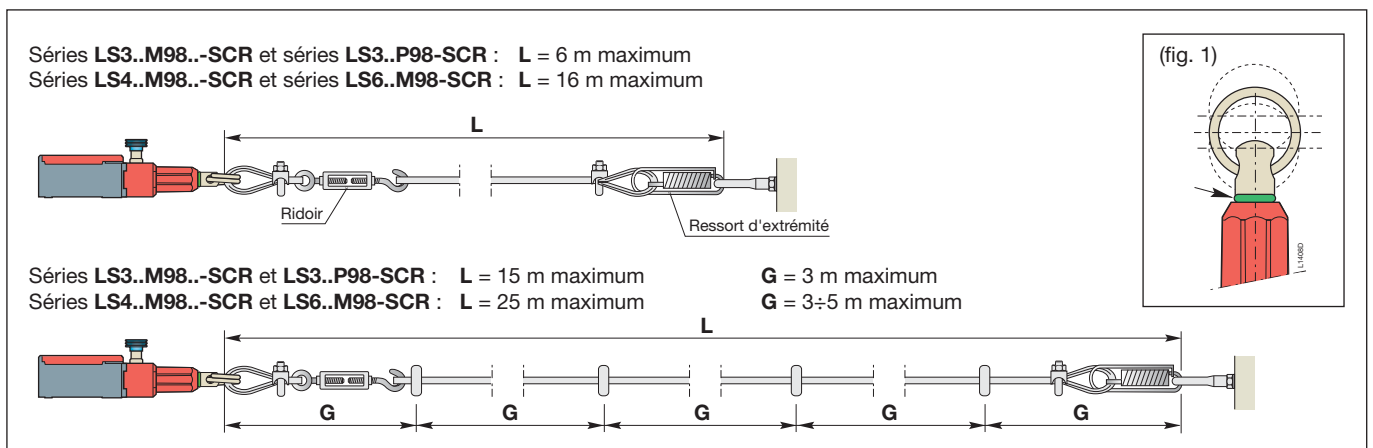

Interrupteurs de position de sécurité

Boîtier plastique IP65 - Boîtier métallique IP66
Caractéristiques techniques

Caractéristiques techniques générales

	Boîtier Plastique	Boîtier Métallique
Normes	IEC 60947-1, IEC 60947-5-1, EN 60947-1, EN 60947-5-1, UL 508, et CSA C22-2 No. 14	
Homologations - Agréments	UL - CSA - CCC	
Température de l'air à proximité de l'appareil		
- en fonctionnement	°C -25 ... +70	
- pour stockage	°C -30 ... +80	
Tenue climatique	Selon IEC 68-2-3 et brouillard salin selon IEC 68-2-11	
Positions de montage	Toutes les positions sont autorisées	
Tenue aux chocs (selon IEC 68-2-27 et EN 60068-2-27) (choc 1/2 sinusoïdal 11 ms) pas de changement d'état des contacts	g Interrupteur de position avec languette (clé) : 10 g Interrupteur de position avec axe rotatif ou levier et à commande par câble : 40 g	
Tenue aux vibrations (selon IEC 68-2-6 et EN 60068-2-6)	g 5 g (10 ... 500 Hz) pas de changement d'état des contacts > 100 μs	
Protection contre les chocs électriques (selon IEC 536)	Classe II	Classe I
Degré de protection (selon IEC 529 et EN 60529)	IP65	IP66

Caractéristiques électriques

Tension assignée d'isolement U_i - selon IEC 60947-1 et EN 60947-1 - selon UL 508, CSA C22-2 No. 14	V	500 (degré de pollution 3) 600	500 (LS4..M.), (LS6..M.), 400 (LS3..M.) - (degré de pollution 3) 600 (LS4..M.), (LS6..M.), 300 (LS3..M.)
Tension assignée de tenue aux chocs U_{imp} (selon IEC 60947-1 et EN 60947-1)	kV	6	
Courant thermique conventionnel sous enveloppe I_{the} (selon IEC 60947-5-1 et EN 60947-5-1) ($\theta \leq 40$ °C)	A	10	
Protection contre les court-circuits - fusibles types gG	A	10	
Courant assigné d'emploi			
I_e / AC-15 - selon IEC 60947-5-1	24 V - 50/60 Hz	A	10
	130 V - 50/60 Hz	A	5.5
	230 V - 50/60 Hz	A	3.1
	240 V - 50/60 Hz	A	3
	400 V - 50/60 Hz	A	1.8
- selon UL 508, CSA C22 N° 14			A 600
			A 600 (LS4..M), (LS6..M) - A 300 (LS3..M)
I_e / DC-13 - selon IEC 60947-5-1	24 V - d.c.	A	2.8
	110 V - d.c.	A	0.6
	250 V - d.c.	A	0.27
- selon UL 508, CSA C22 N° 14			Q 600
			Q 600 (LS4..M), (LS6..M) - Q 300 (LS3..M)
Positivité			Contacts à manœuvre positive d'ouverture selon IEC 60947-5-1 chapitre 3 et EN 60947-5-1
Résistance entre les contacts	mΩ	25	
Durabilité mécanique	Millions d'opérations	> 1 million	
Fréquence de manœuvre maxi.	Cycles/h	600	
Durabilité électrique (selon IEC 60947-5-1 annexe C) - fréquence de manœuvre maxi - facteur de marche	Cycles/h	Catégories d'utilisation AC-15 et DC-13 (voir courbes et valeurs ci-dessous) 3600 0.5	
Caractéristiques de connectique des blocs contacts			
Bornes de raccordement		Vis M3.5 à tête (+,-) pozidriv 2 avec serre-fils	
Capacité de raccordement	1 ou 2 x mm ² / AWG	0.5 mm ² / AWG 20 à 2.5 mm ² / AWG 14	
Marquage des bornes		Selon EN 50013	

Durabilité électrique en catégorie d'emploi AC-15

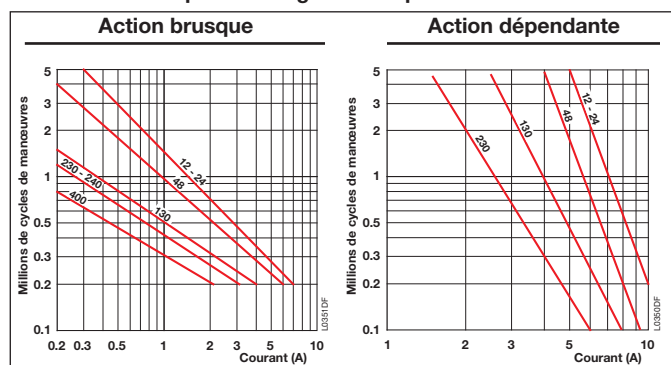

Durabilité électrique en catégorie d'emploi DC-13

	Action brusque	Action dépendante
Puissance coupée pour une durabilité de 5 millions de cycles de manœuvres		
Tension 24 V	9.5 W	12 W
Tension 48 V	6.8 W	9 W
Tension 110 V	3.6 W	6 W

LS3..P80..-S and LS3..M80..-S Limit Switches with Small Latch (Key) and adjustable Head

1 Cable Inlet for Cable Gland

Movement to be detected:

Small Latch (Key), Front or Vertical Translation

Casing 30 mm width

- Plastic: Degree of protection IP65
- Metal: Degree of protection IP66



Actuator

Conformity / \rightarrow (N.C. contact with positive opening operation)
 Actuation speed: maximal / minimal
 Min. force / torque: - for insertion of the key
 - for extraction of the key
 - positive opening operation

Key

\rightarrow
 0.5 / 0.01 m/s
 15 N
 15 N
 30 N

Key

\rightarrow
 0.5 / 0.01 m/s
 15 N
 15 N
 30 N

Additional Technical Data (Operating diagrams with keys inserted)

LS type code to be complete with the cable inlet code [0] = Pg 13.5
 [1] = Pg 11
 [2] = M16 x 1.5
 [3] = M20 x 1.5
 [5] = 1/2" NPT (by plastic adaptor for LS3..P80..-S)

Contacts	Type	LS3 □ P80D11-S	LS3 □ M80D11-S
Snap action contacts slow action contacts 	Operation diagram		
Simultaneous Slow action contacts 	Operation diagram		
Weight (packing per unit)	kg	0.080	0.180

Special heads, accessories and special contact arrangement or particular function: please consult us.

Closed contact / Open contact

Dimensions (mm)

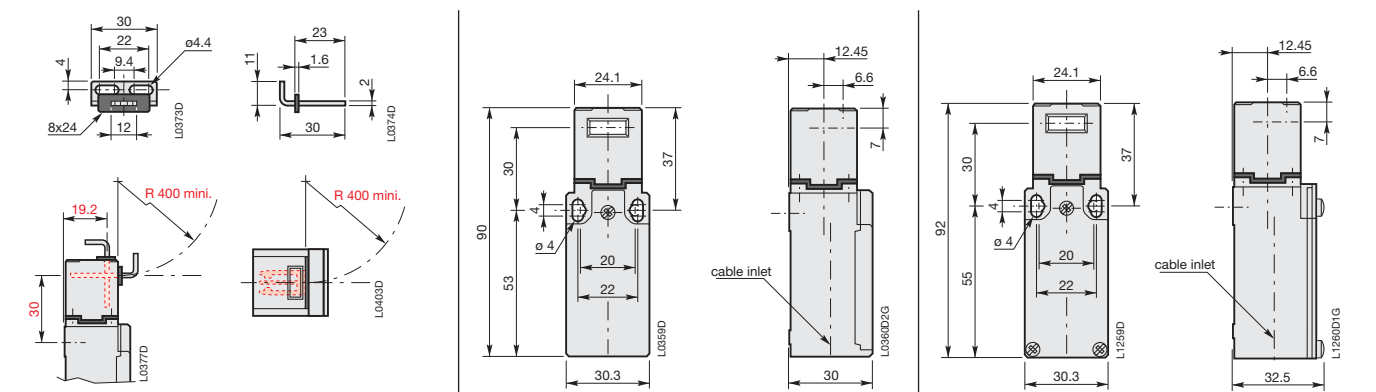

LS4..P80..-S and LS4..M80..-S Limit Switches with Small Latch (Key) and adjustable Head

1 Cable Inlet for Cable Gland

Movement to be detected:

Small Latch (Key), Front or Vertical Translation

Casing 40 mm width

- Plastic: Degree of protection IP65
- Metal: Degree of protection IP66



Actuator

	Key	Key
Conformity / \rightarrow (N.C. contact with positive opening operation)	\rightarrow	\rightarrow
Actuation speed: maximal / minimal	0.5 / 0.01 m/s	0.5 / 0.01 m/s
Min. force / torque: - for insertion of the key	30 N	30 N
- for extraction of the key	30 N	30 N
- positive opening operation	45 N	45 N

Additional Technical Data (Operating diagrams with keys inserted)

LS type code to be complete with the cable inlet code[0] = Pg 13.5
 [3] = M20 x 1.5
 [5] = 1/2" NPT

	Type	LS4 □ P80D12-S	LS4 □ M80D12-S
Non-overlapping slow action contacts	Operation diagram		
Simultaneous Slow action contacts	Operation diagram		
Weight (packing per unit)	kg	0.155	0.210

Special heads, accessories and special contact arrangement or particular function: please consult us.

Closed contact / Open contact

Dimensions (mm)

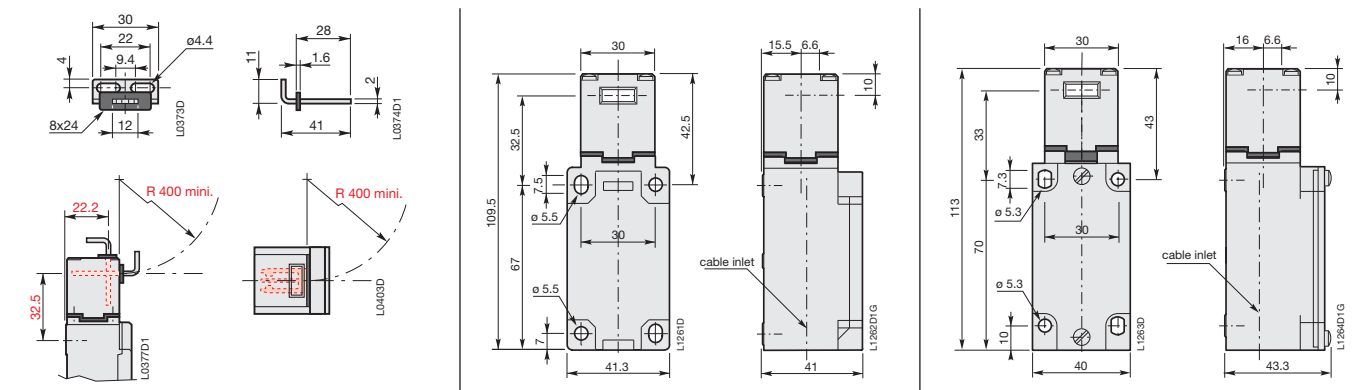

LS3..P7..-S and LS3..M7..-S Limit Switches with Rotative Axis and adjustable Head

1 Cable Inlet for Cable Gland

Movement to be detected:

Angular Around Rotative Axis

Casing 30 mm width

- Plastic: Degree of protection IP65
- Metal: Degree of protection IP66



Actuator

Conformity / \rightarrow (N.C. contact with positive opening operation)
 Actuation speed: maximal / minimal
 Min. force / torque: - actuation
 - positive opening operation



0.5 / 0.01 m/s
 0.12 N.m
 0.60 N.m



0.5 / 0.01 m/s
 0.12 N.m
 0.60 N.m

Additional Technical Data

LS type code to be complete with the cable inlet code

- 0 = Pg 13.5
- 1 = Pg 11
- 2 = M16 x 1.5
- 3 = M20 x 1.5
- 5 = 1/2" NPT (by plastic adaptor for LS3..P7..-S)

	Type	LS3 0 P75D11-S	LS3 0 M75D11-S	LS3 0 P76D11-S	LS3 0 M76D11-S
Non-overlapping slow action contacts 	Operation diagram				
Simultaneous Slow action contacts 	Operation diagram				
Weight (packing per unit)	kg	0.090	0.190	0.090	0.190

Special heads, accessories and special contact arrangement or particular function: please consult us.

Closed contact / Open contact

Dimensions (mm)

Plastic Casing
 (for Metal Casing see page 54)

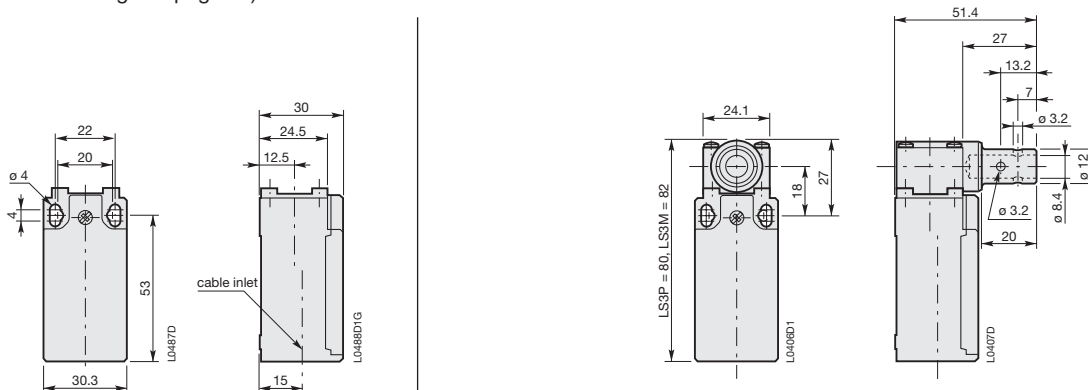

LS3..P7..-S and LS3..M7..-S Limit Switches with Right Angle Lever and Adjustable Head

1 Cable Inlet for Cable Gland

Movement to be detected:

Angular with Lever

Casing 30 mm width

- Plastic: Degree of protection IP65
- Metal: Degree of protection IP66



Lever adjusted to the left (by user)

Lever in central position (factory assembled)

Lever adjusted to the right (by user)

Galvanized steel flush mounting right angle lever

Actuator

Conformity / \ominus (N.C. contact with positive opening operation)
 Actuation speed: maximal/minimal
 Min. force / torque: - actuation
 - positive opening operation

\ominus
 0.5 / 0.01 m/s
 0.12 N.m
 0.60 N.m

Additional Technical Data

LS type code to be complete with the cable inlet code

- 0 = Pg 13.5
- 1 = Pg 11
- 2 = M16 x 1.5
- 3 = M20 x 1.5
- 5 = 1/2" NPT (by plastic adaptor for LS..P7..-S)

Non-overlapping slow action contacts

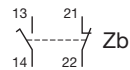

Type

LS3 □ P77D11-S / LS3 □ M77D11-S

Operation diagram

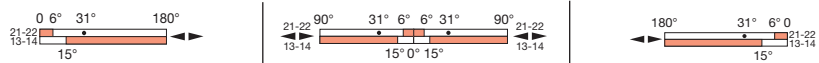

Simultaneous Slow action contacts



Type

LS3 □ P77L02-S / LS3 □ M77L02-S

Operation diagram

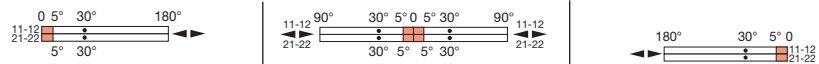

Weight (packing per unit)

kg

LS3..P77..-S = 0.110 kg / LS3..M77..-S = 0.210 kg

Special heads, accessories and special contact arrangement or particular function: please consult us.

■ Closed contact / □ Open contact

Dimensions (mm)

Metal Casing

(for Plastic Casing see page 53)

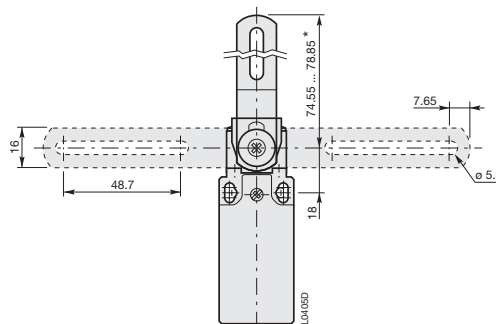
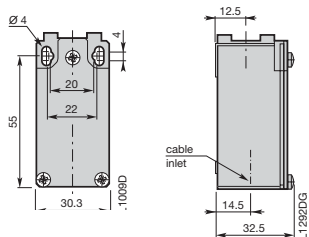

* Adjusted to maximum by factory

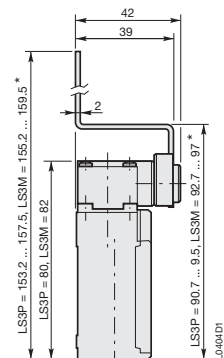

LS3..P98..-SCR, LS3..M98..-SCR, LS4..M98..-SCR and LS6..M98..-SCR Safety Limit Switches

With Pulling Cable for Emergency Stop and Manual Reset

Movement to be detected:

Stop by Pulling the cable

Casing 30 mm width

- Plastic: Degree of protection IP65
- Metal: Degree of protection IP66
- 1 cable inlet for cable gland

Casing 40 mm width

- Metal: Degree of protection IP66
- 1 cable inlet for cable gland

Casing 60 mm width

- Metal: Degree of protection IP66
- 3 cable inlets for cable gland

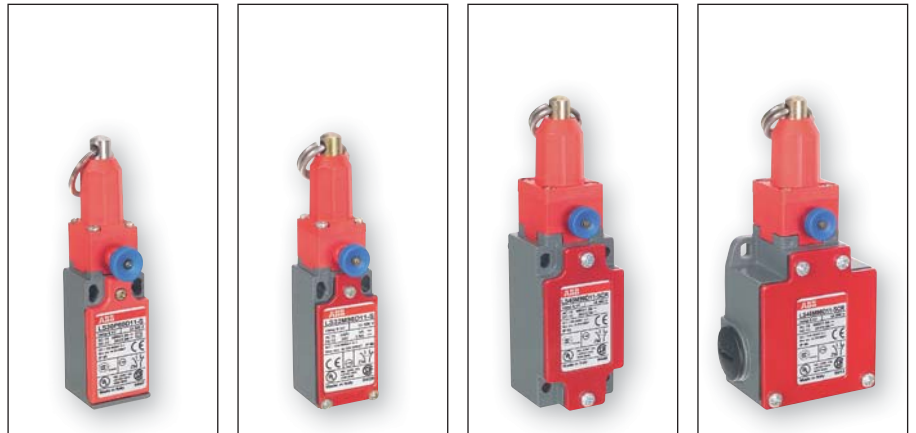

Actuator

Conformity / (N.C. contact with positive opening operation)
 Min. force : - for arming the safety system (F)
 - for actuation
 - for activating the reset and stop (F1)
 - positive opening operation

Red cable

70 N
 95 N
 120 N
 115 N

Red cable

100 N
 170 N
 250 N
 240 N

Additional Technical Data

LS type code to be complete with the cable inlet code
 0 = Pg 13.5
 1 = Pg 11 (except for LS4..M98..-SCR and LS6..M98..-SCR)
 2 = M16 x 1.5 (except for LS4..M98..-SCR and LS6..M98..-SCR)
 3 = M20 x 1.5
 5 = 1/2" NPT (by plastic adaptor for LS3..P98..-SCR)

	Type	LS3 □ P98D11-SCR	LS3 □ M98D11-SCR	LS4 □ M98D11-SCR	LS6 □ M98D11-SCR
Non-overlapping slow action contacts	Operation diagram				
Simultaneous slow action contacts	Operation diagram				
Non-overlapping slow action contacts	Operation diagram				
Simultaneous slow action contacts	Operation diagram				
Weight (packing per unit)	kg	0.115	0.270	0.270	0.300

Closed contact / Open contact

Dimensions (mm)

LS3..P98..-SCR

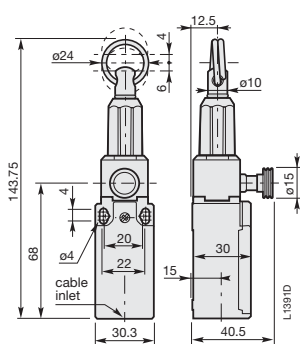

LS3..M98..-SCR

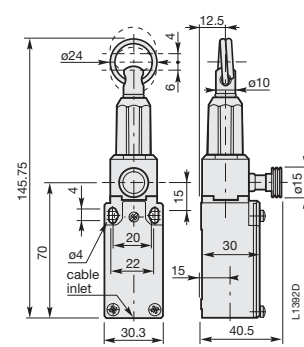

LS4..M98..-SCR

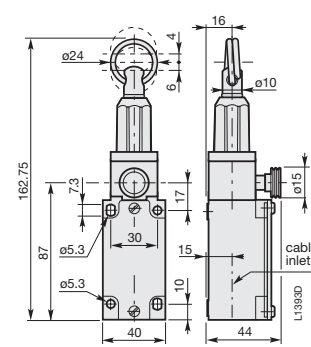

LS6..M98..-SCR

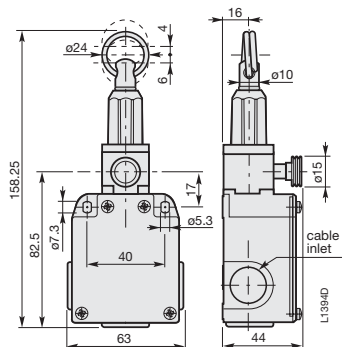

Limit Switches with Latch and Manual Reset

Plastic Casing IP65  and Metal Casing IP66 - 30 mm Width

Applications

Easy to use, the limit switches for safety applications with latch and manual reset offer specific qualities:

- Visible operation (fault memorisation).
- Capability for strong current switching (conventional thermal current 10 A).
- Contact blocks with positive opening operation of the "N.C." normally closed contact(s) (symbol ⊖).
- Electrically separated contacts.
- Precision on operating positions (consistency).
- Immunity to electromagnetic disturbances.

These specific features make the limit switches ideal for detection and monitoring of faults in hoisting machines, electric lifts, freight elevators, escalators, conveyor belts, etc.

Limit switches with latch and manual reset comply with the requirements of standard EN 81-1: safety rules for the construction and installations of electric lifts. In this application they detect or monitor: cabin overtravel, cabin speed by means of a speed limiting device, energisation of the parachute block on detection of excessive speed with respect to the set-point value, etc.

They comply with the requirements of European Directives (Low Voltage, Machines and Electromagnetic Compatibility) and are conform to European and international standards.

Description

LS3..P.-R (plastic casing, 30 mm width) limit switches with latch and manual reset, which are made of fibreglass reinforced UL-V0 thermoplastic material, offer double insulation  and a degree of protection IP65.

LS3..M.-R (metal casing, 30 mm width) limit switches, which are made of zinc alloy (zamack), have a degree of protection IP66.

Limit switches with latch and manual reset are equipped with 1 N.C. + 1 N.O. or 2 N.C. contact blocks with positive opening operation of the "N.C." contact(s). After actuating the control device and overshooting the latching point, the N.C. safety contact(s) remain in the open position.

Return to the initial operating state takes place by voluntary action on the reset button.

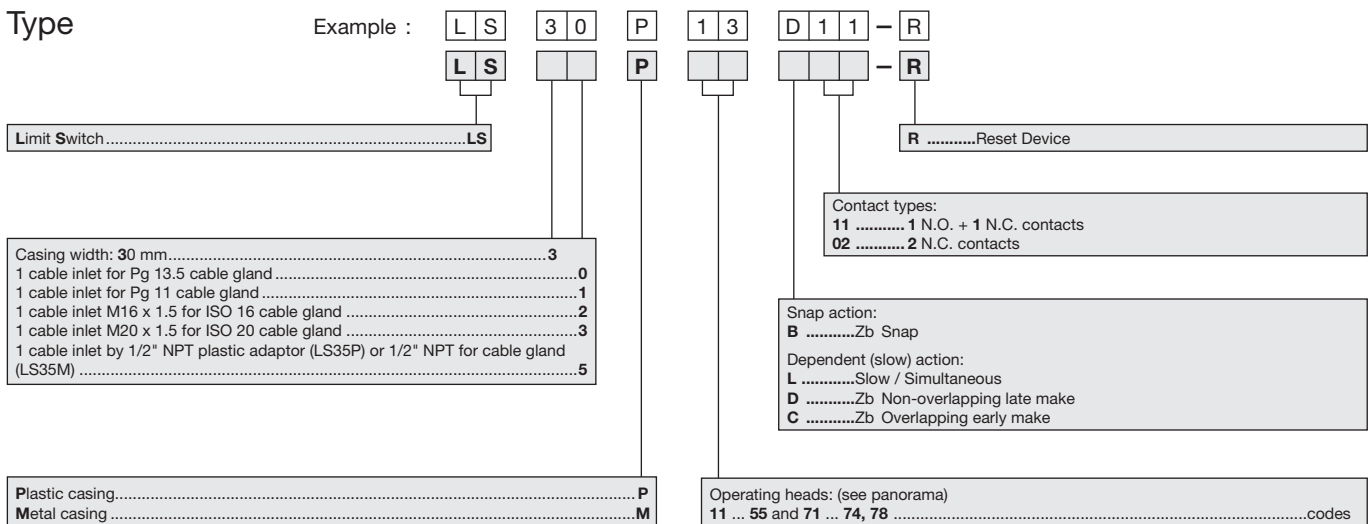
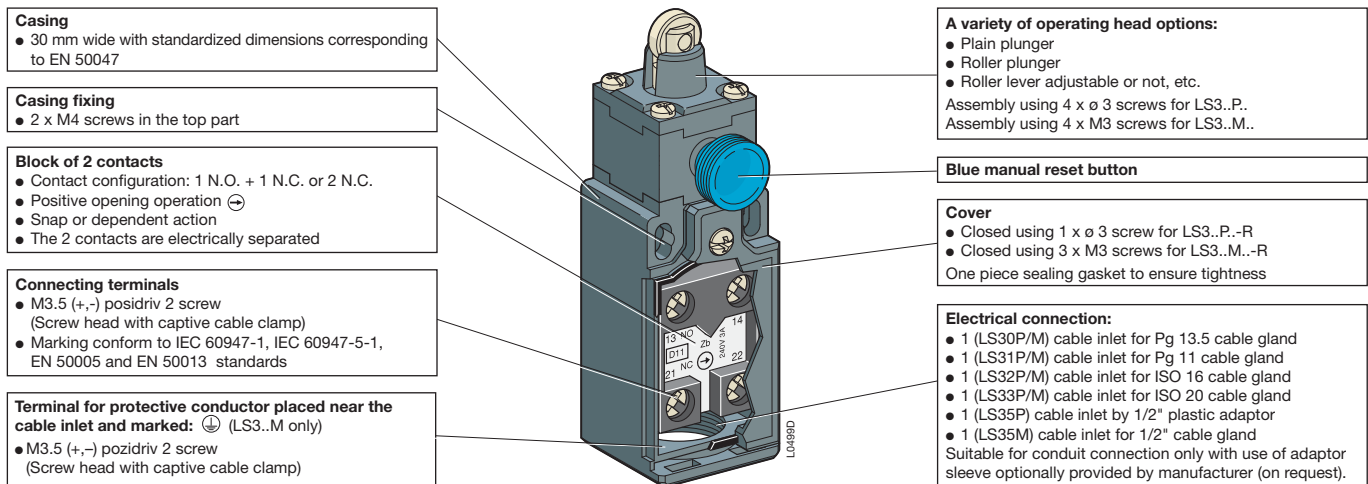

LS3..P..-R and LS3..M..-R Limit Switches with Latch and Manual Reset

Plastic Casing IP65 and Metal Casing IP66 - 30 mm Width



LS31P11D11-R



LS31P13D11-R



LS32M31D11-R



LS32M41D11-R

LS30P: 1 cable inlet for Pg 13.5 cable gland	0	0	2
LS31P: 1 cable inlet for Pg 11 cable gland	1	0	1
LS32P: 1 cable inlet for ISO 16 cable gland	2	0	3
LS33P: 1 cable inlet for ISO 20 cable gland	3	2	2
LS35P: 1 cable inlet by 1/2" NPT plastic adaptor ..	5	2	1
LS30M: 1 cable inlet for Pg 13.5 cable gland	0	1	8
LS31M: 1 cable inlet for Pg 11 cable gland	1	1	7
LS32M: 1 cable inlet for ISO 16 cable gland	2	1	9
LS33M: 1 cable inlet for ISO 20 cable gland	3	3	8
LS35M: 1 cable inlet by 1/2" NPT plastic adaptor ..	5	3	7

Plastic Casing - 30 mm Width
IP65

Metal Casing - 30 mm Width
IP66

Ordering Details

Contact blocks	Type	Order code	Weight kg (1)
 D11	state cable inlet code <input type="checkbox"/>	state cable inlet code <input type="checkbox"/> <input type="checkbox"/>	Pack ^{m9} 1 piece
 B02			

Plastic Limit Switches with steel plain plunger (zinc plated)

1	-	LS3 <input type="checkbox"/> P11D11-R	1SBV02 <input type="checkbox"/> <input type="checkbox"/> 11R1411	0.090
-	1	LS3 <input type="checkbox"/> P11B02-R	1SBV02 <input type="checkbox"/> <input type="checkbox"/> 11R1202	0.090

Plastic Limit Switches with plastic (polyacetal) roller plunger

1	-	LS3 <input type="checkbox"/> P13D11-R	1SBV02 <input type="checkbox"/> <input type="checkbox"/> 13R1411	0.090
-	1	LS3 <input type="checkbox"/> P13B02-R	1SBV02 <input type="checkbox"/> <input type="checkbox"/> 13R1202	0.090

Plastic Limit Switches with plastic roller (polyacetal) lever

1	-	LS3 <input type="checkbox"/> P41D11-R	1SBV02 <input type="checkbox"/> <input type="checkbox"/> 41R1411	0.095
-	1	LS3 <input type="checkbox"/> P41B02-R	1SBV02 <input type="checkbox"/> <input type="checkbox"/> 41R1202	0.095

Metal Limit Switches with steel plain plunger (zinc plated)

1	-	LS3 <input type="checkbox"/> M11D11-R	1SBV02 <input type="checkbox"/> <input type="checkbox"/> 11R1411	0.190
-	1	LS3 <input type="checkbox"/> M11B02-R	1SBV02 <input type="checkbox"/> <input type="checkbox"/> 11R1202	0.190

Metal Limit Switches with plastic (polyacetal) roller lever on steel plunger (zinc plated)

1	-	LS3 <input type="checkbox"/> M31D11-R	1SBV02 <input type="checkbox"/> <input type="checkbox"/> 31R1411	0.195
-	1	LS3 <input type="checkbox"/> M31B02-R	1SBV02 <input type="checkbox"/> <input type="checkbox"/> 31R1202	0.195

Metal Limit Switches with plastic roller (polyacetal) lever

1	-	LS3 <input type="checkbox"/> M41D11-R	1SBV02 <input type="checkbox"/> <input type="checkbox"/> 41R1411	0.195
-	1	LS3 <input type="checkbox"/> M41B02-R	1SBV02 <input type="checkbox"/> <input type="checkbox"/> 41R1202	0.195

(1) For LS 35P add 0.007 kg

Limit Switches with Latch and Manual Reset

Travel and Operation diagrams

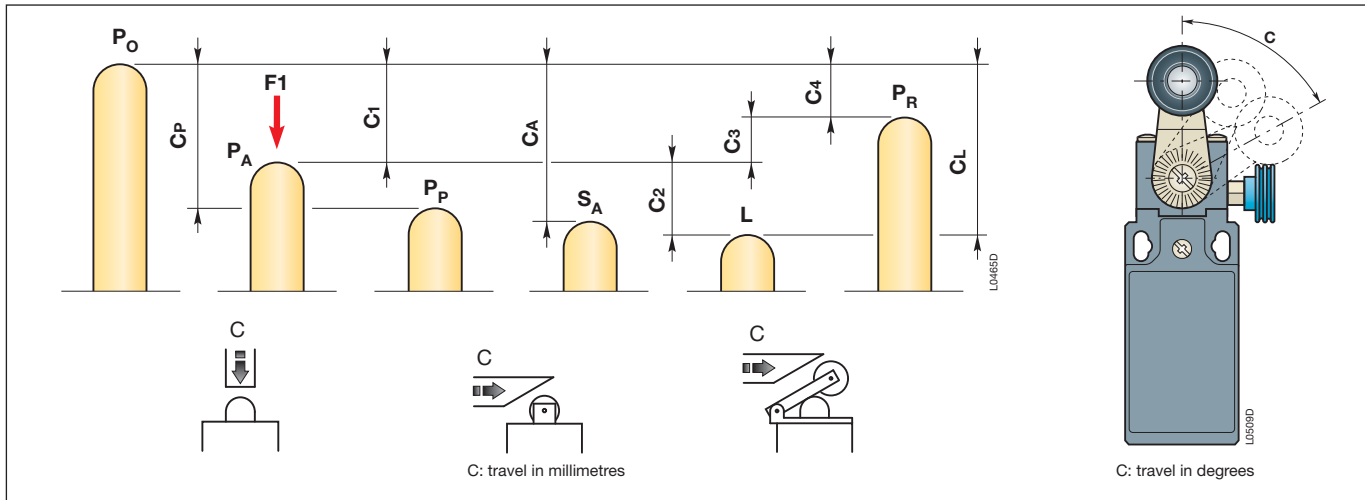

P_O Free position:

position of the switch actuator when no external force is exerted on it.

P_A Operating position:

position of the switch actuator, under the effect of force **F1**, when the contacts leave their initial free position.

P_P Positive opening position:

position of the switch actuator from which positive opening is ensured.

S_A Latching point:

point of no return of the switch actuator beyond which the opened status of the (N.C.) contact(s) is maintained. Unlocking will only occur after deliberate action on the reset button.

L Max. travel position:

maximum acceptable travel position of the switch actuator under the effect of a force **F1**.

P_R Release position:

position of the switch actuator when the contacts return to their initial free position.

C₁ Pre-travel (average travel):

distance between the free position **P_O** and the operating position **P_A**.

C_P Positive opening travel:

minimum travel of the switch actuator, from the free position, to ensure positive opening operation of the normally closed contact (N.C.).

C_A Latching travel (average travel):

distance between the free position **P_O** and the latching point **S_A**.

C₂ Over-travel (average travel):

distance between the operating position **P_A** and the max. travel position **L**.

C_L Max. travel (maximum travel):

distance between the free position **P_O** and the max. travel position **L**.

C₃ Differential travel (C₁-C₄) (average travel):

travel difference of the switch actuator between the operating position **P_A** and the release position **P_R**.

C₄ Release travel (average travel):

distance between the release position **P_R** and the free position **P_O**.

Diagram for snap action contacts:

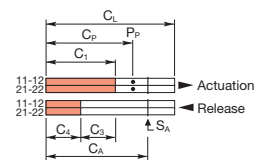
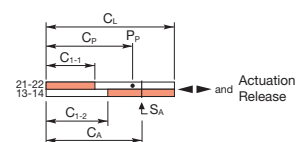

Diagram for non-overlapping slow action contacts:



Contacts position

21-22 Contact closed
 21-22 Contact open
 ↑ Contacts identification (example)

Note: for slow action contacts, **C₃ = 0**, **C₁₋₁** = pre-travel of contact 21-22, **C₁₋₂** = pre-travel of contact 13-14.

Examples:

LS30P13D11-R

non-overlapping slow action contacts

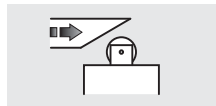
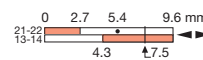

Diagram in millimetres / cam travel



LS30P41L02-R

simultaneous slow action contacts

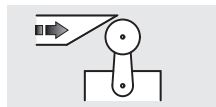

Diagram in degrees / lever rotation



LS30P11B02-R

snap action contacts

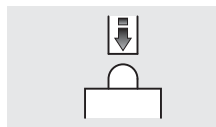
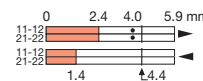

Diagram in millimetres / plunger travel



Limit Switches with Latch and Manual Reset

Technical Data

General Technical Data

	Plastic Casing	Metal Casing
Standards	IEC 60947-1, IEC 60947-5-1, EN 60947-1, EN 60947-5-1, UL 508, CSA C22-2 No.14	
Certifications - Approvals	UL - CSA - CCC	
Air temperature near the device		
- during operation	°C -25 ... +70	
- for storage	°C -30 ... +80	
Climatic withstand	According to IEC 68-2-3 and salty mist according to IEC 68-2-11	
Mounting positions	All positions are authorised	
Shock withstand (according to IEC 68-2-27 and EN 60068-2-27)	g 50 g (1/2 sinusoidal shock for 11 ms) no change in contact position	
Resistance to vibrations (acc. to IEC 68-2-6 and EN 60068-2-6)	g 25 g (10 ... 500 Hz) no change in position of contacts > 100 µs	
Protection against electrical shocks (acc. to IEC 536)	Class II	Class I
Degree of protection (according to IEC 529 and EN 60529)	IP65	IP66
Consistency	0.1 mm upon closing points	

Electrical Data

Rated insulation voltage U_i			
- according to IEC 60947-1 and EN 60947-1	V	500 (degree of pollution 3)	400 (degree of pollution 3)
- according to UL 508, CSA C22-2 No.14	V	600	300
Rated impulse withstand voltage U_{imp}	kV	6	
(according to IEC 60947-1 and EN 60947-1)			
Conventional enclosed thermal current I_{the}	A	10	
(according to IEC 60947-5-1 and EN 60947-5-1) ($\theta \leq 40$ °C)			
Short-circuit protection gG type fuses	A	10	
Rated operational current			
I_e / AC-15 - acc. to IEC 60947-5-1			
24 V - 50/60 Hz	A	10	
130 V - 50/60 Hz	A	5.5	
230 V - 50/60 Hz	A	3.1	
240 V - 50/60 Hz	A	3	
400 V - 50/60 Hz	A	1.8	
- according to UL 508, CSA C22 No.14		A 600	A 300
I_e / DC-13 - according to IEC 60947-5-1			
24 V - d.c.	A	2.8	
110 V - d.c.	A	0.6	
250 V - d.c.	A	0.27	
- according to UL 508, CSA C22 No.14		Q 600	Q 300
Positivity		Contacts with positive opening operation as per IEC 60947-5-1 chapter 3 and EN 60947-5-1	
Resistance between contacts	mΩ	25	
Mechanical durability	Millions of operations	> 1 million	
Max. switching frequency	Cycles/h	600	
Electrical durability (according to IEC 60947-5-1 appendix C)		Utilization categories AC-15 and DC-13 (see curves and values below)	
- Max. switching frequency	Cycles/h	3600	
- Load factor		0.5	
Connecting data of contact blocks			
Connecting terminals		M3.5 (+,-) pozidriv 2 screw with cable clamp	
Connecting capacity	1 or 2 x mm ² / AWG	0.5 mm ² / AWG 20 to 2.5 mm ² / AWG 14	
Terminal marking		According to EN 50013	

Electrical durability for AC-15 utilization category

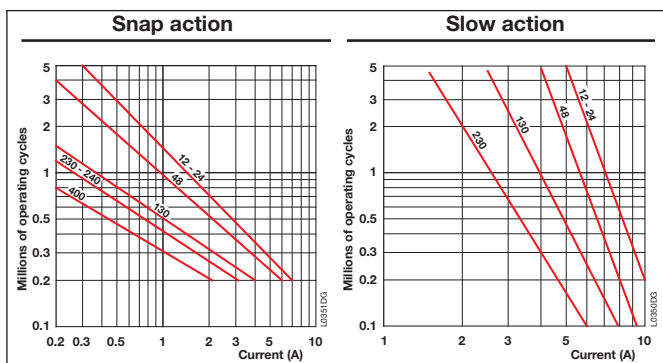

Electrical durability for DC-13 utilization category

	Snap action	Slow action
	Power breaking for a durability of 5 million operating cycles	
Voltage 24 V	9.5 W	12 W
Voltage 48 V	6.8 W	9 W
Voltage 110 V	3.6 W	6 W

LS3..P.-R Limit Switches with Latch and Manual Reset

1 Cable Inlet for Cable Gland

Movement to be detected:

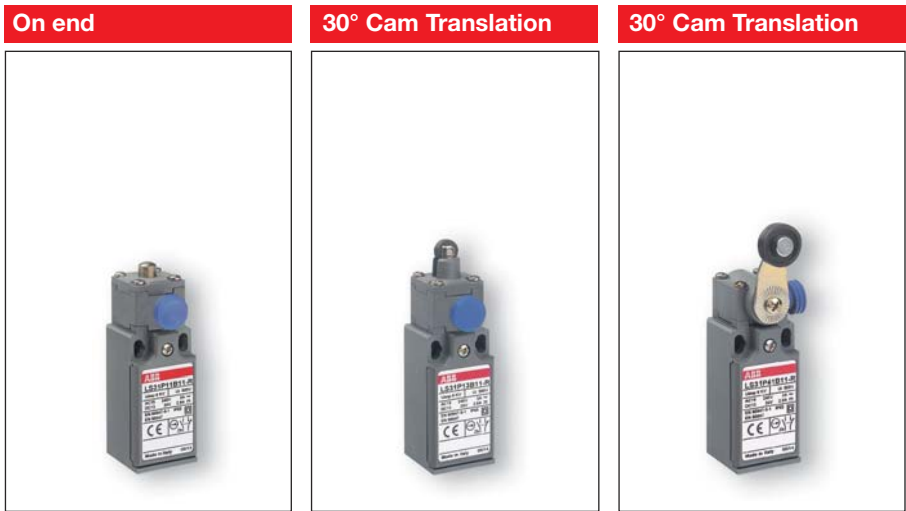

Casing

- Plastic
- 30 mm width
- Degree of protection IP65

Actuator

	Steel plain plunger	ø11 Plastic roller plunger	ø18 Rotary lever with plastic roller
Conformity / \rightarrow (N.C. contact with positive opening operation)	\rightarrow	\rightarrow	\rightarrow
Maximum actuation speed	0.5 m/s	0.3 m/s	1.5 m/s
Min. force / torque: - actuation	9 N	12 N	0.10 N.m
- positive opening operation	44 N	41 N	0.32 N.m

Additional Technical Data

LS type code to be complete with the cable inlet code
 0 = Pg 13.5
 1 = Pg 11
 2 = M16 x 1.5
 3 = M20 x 1.5
 5 = 1/2" NPT (by plastic adaptor)

Non-overlapping slow action contacts 	Type	LS3 □ P11D11-R	LS3 □ P13D11-R	LS3 □ P41D11-R
Operation diagram				
Snap action contacts 	Type	LS3 □ P11B02-R	LS3 □ P13B02-R	LS3 □ P41B02-R
Operation diagram				
Weight (packing per unit)	kg	0.090	0.090	0.95

Closed contact / Open contact

Dimensions (mm)

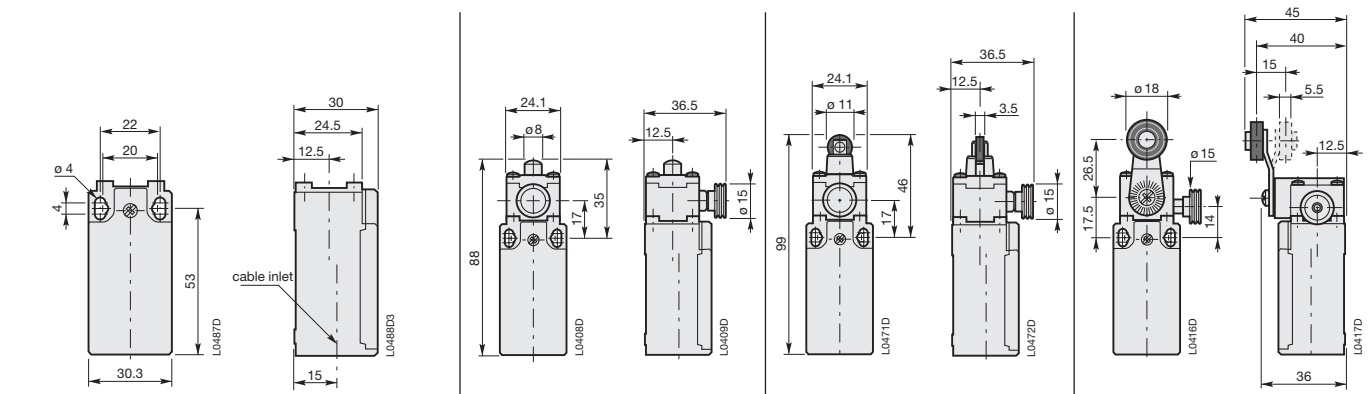





LS3..M..-R Limit Switches with Latch and Manual Reset

1 Cable Inlet for Cable Gland

Movement to be detected:





Actuator

	Steel plain plunger	ø12.5 Plastic roller plunger on galvanized steel plunger	ø18 Rotary lever with plastic roller
Conformity /  (N.C. contact with positive opening operation)			
Maximum actuation speed	0.5 m/s	1 m/s	1.5 m/s
Min. force / torque: - actuation	9 N	7 N	0.10 N.m
- positive opening operation	44 N	24 N	0.32 N.m

Additional Technical Data

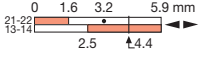
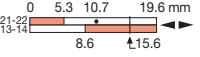
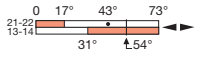
LS type code to be complete with the cable inlet code
 [0] = Pg 13.5
 [1] = Pg 11
 [2] = M16 x 1.5
 [3] = M20 x 1.5
 [5] = 1/2" NPT

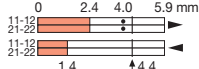
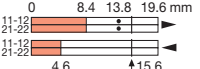
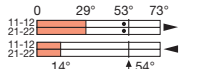
	Type	LS3 □ M11D11-R	LS3 □ M31D11-R	LS3 □ M41D11-R
<p>Non-overlapping slow action contacts</p>  Zb	Operation diagram			
<p>Simultaneous slow action contacts</p> 	Operation diagram			
Weight (packing per unit)	kg	0.190	0.195	0.195

 Closed contact /  Open contact

Dimensions (mm)

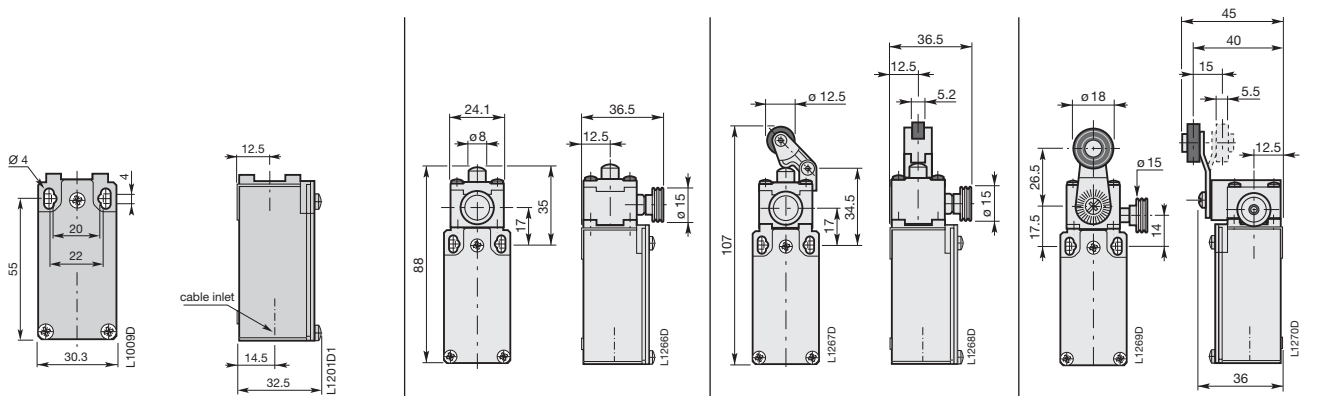

Foot Switches

IPS Foot Switches with Covers, IPM Mini Foot Switches Description

Application

Foot switch operated machines such as: shearing machines, folding machines, spinning lathes, machine tools, wrapping machines, riveting presses, etc.

Foot switches with covers come in three operation formats:

- **Free movement:** contact position follows pedal movement: actuated when the pedal is pushed down, released when pedal is in a state of rest.
- **Foot switch locked in neutral position:** same operation as above, after unlocking the pedal with the end of the foot.
- **Foot switch latched in low position:** same operation as free movement, except that a state of rest is obtained only after having unlatched the pedal with the end of the foot.

Description of IPS Foot Switches with Covers

- **Dimensions:** 285 x 140 x 145.
- **Materials:** base, cover and pedal made of shock resistant Bayblend® FR 90 material (alloyed polycarbonate and ABS).
- **Colour choice:** grey base; grey, yellow or red cover.
- **Variations:** grey base, half-red cover. Especially used for emergency stop function.

Note: this emergency stop function must never contain the «locked in neutral position» device.

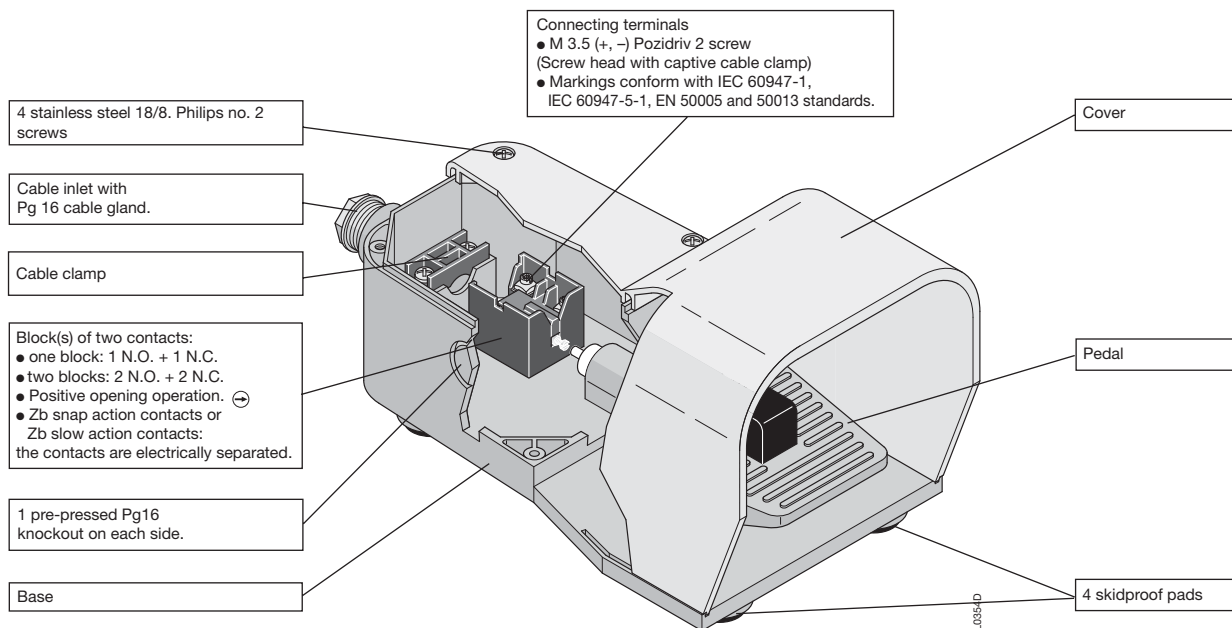

On request: Foot switches with covers can be assembled on a plate and equipped with a transportation handle. Instead of the handle an emergency stop button can be installed above a tube that allows for connection cable passage. (see the catalogue of separate elements)

Description of IPM Mini Foot Switches

- **Reduced dimensions:** 100 x 75 x 34 mm.
- **Materials:** cover and base made of self-extinguishing ABS.
- **Colour choice:** black or grey base; black, grey, yellow or red cover.

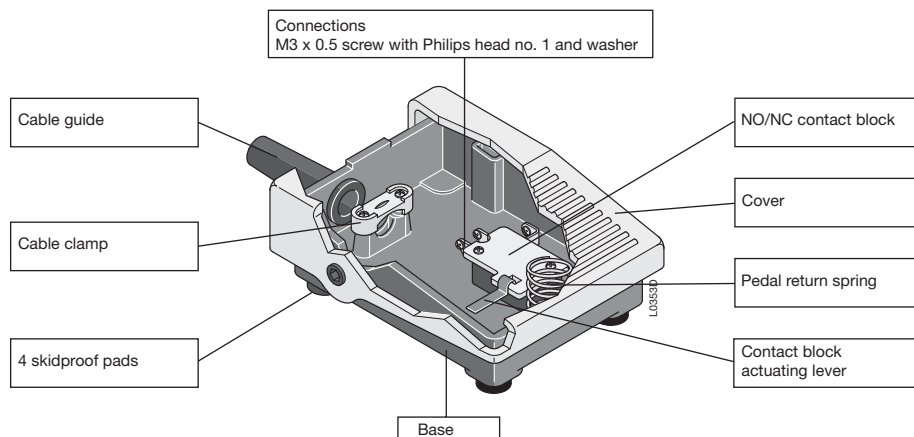

Foot Switches

IPS Foot Switches with Covers IPM Mini Foot Switches

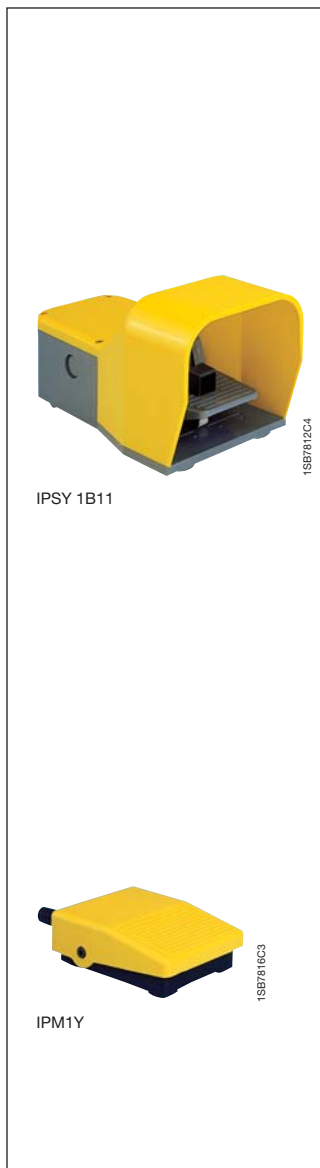

IPSY: Yellow Cover **Y** **5**
 IPSG: Grey Cover **G** **6**
 IPSR: Red Cover **R** **8**

Ordering Details

Contact blocks	Type	Order code	Weight kg (1)
Snap action	state colour code <input type="checkbox"/>	state colour code <input type="checkbox"/>	Pack ^{ing} 1 piece
Non-overlapping Slow action			
 B11			
 D11			

Free Movement

1	-	IPS <input type="checkbox"/> 1B11	1SBV 002 10 <input type="checkbox"/> R1211	1.100
-	1	IPS <input type="checkbox"/> 1D11	1SBV 002 10 <input type="checkbox"/> R1411	1.100

Locked in Neutral Position

1	-	IPS <input type="checkbox"/> 2B11	1SBV 002 20 <input type="checkbox"/> R1211	1.100
-	1	IPS <input type="checkbox"/> 2D11	1SBV 002 20 <input type="checkbox"/> R1411	1.100

Latched in Low Position

1	-	IPS <input type="checkbox"/> 3B11	1SBV 002 30 <input type="checkbox"/> R1211	1.100
-	1	IPS <input type="checkbox"/> 3D11	1SBV 002 30 <input type="checkbox"/> R1411	1.100

Ordering Details

Contact blocks	Cover colour	Type	Order code	Weight kg (1)
 N.O. / N.C.				Pack ^{ing} 1 piece

Black Base

1	Yellow	IPM1Y	1SBV 001 101 R1823	0.130
1	Grey	IPM1G	1SBV 001 102 R1823	0.130

Grey Base

1	Yellow	IPM2Y	1SBV 001 105 R1823	0.130
1	Grey	IPM2G	1SBV 001 106 R1823	0.130

Dimensions (mm)

Foot Switches with cover

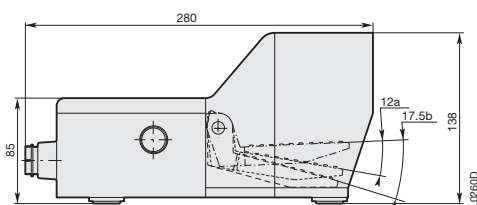

Plain foot switch - a = pre-travel, b = total travel

Mini Foot Switches

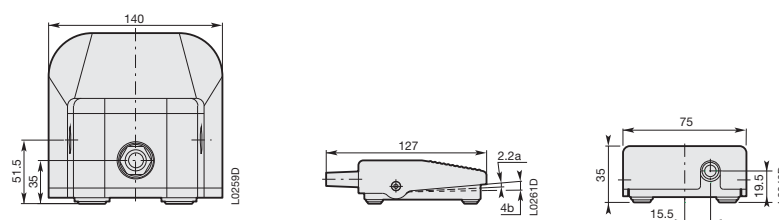

Foot Switches

Technical Data

General Technical Data

	Mini Foot Switch	Foot Switch with cover
Standards	IEC 1058-1	IEC 60947-1, IEC 60947-5-1, EN 60947-1, EN 60947-5-1, UL 508, CSA C22-2 No.14
Certifications - Approvals	–	UL - CSA - BG - CCC
Air temperature near the device		
– during operation	°C -10 ... +70	-10 ... +70
– for storage	°C -25 ... +80	-30 ... +80
Climatic withstand	–	According to IEC 68-2-3 and salty mist according to IEC 68-2-11
Shock withstand (according to IEC 68-2-27 and EN 60068-2-27)	g –	50 g (1/2 sinusoidal shock for 11 ms) no change in contact position
Resistance to vibrations (acc. to IEC 68-2-6 and EN 60068-2-6)	g –	25 g (10 ... 500 Hz) no change in position of contacts > 100 μs
Protection against electrical shocks (acc. to IEC 536)	Class II	Class II
Degree of protection (according to IEC 529 et EN 60529)	IP40	IP65
Operating angle	Degree 2 to 4	15
Actuation torque	N.m. 1.2	0.25

Electrical Data

Rated insulation voltage U_i	V	250	–
– according to IEC 60947-1 and EN 60947-1	V	–	500 (degree of pollution 3)
– according to UL 508, CSA C22-2 No.14	V	–	600
Rated impulse withstand voltage U_{imp}	kV	1	6 (according to IEC 60947-1 and EN 60947-1)
Conventional free air thermal current I_{th}	A	15	10 (according to IEC 60947-5-1 and EN 60947-5-1) ($\theta \leq 40$ °C)
Short-circuit protection gG type fuses	A	10	10
Rated operational current			
250 V - a.c.	A	3	–
230 V - d.c.	A	0.06	–
I_e / AC-15 – acc. to IEC 60947-5-1			
24 V - 50/60 Hz	A	–	10
130 V - 50/60 Hz	A	–	5.5
230 V - 50/60 Hz	A	–	3.1
240 V - 50/60 Hz	A	–	3
400 V - 50/60 Hz	A	–	1.8
– according to UL 508, CSA C22 No.14			A 600
I_e / DC-13 – according to IEC 60947-5-1			
24 V - d.c.	A	–	2.8
110 V - d.c.	A	–	0.6
250 V - d.c.	A	–	0.27
– according to UL 508, CSA C22 No.14			Q 600
Positivity			Contacts with positive opening operation as per IEC 60947-5-1 chapter 3 and EN 60947-5-1
Resistance between contacts	mΩ	30	25
Mechanical durability	Millions of operations	10	30
Max. switching frequency	Cycles/h	–	600
Electrical durability	Operations	100000	(according to IEC 60947-5-1 appendice C) Utilization categories AC-15 and DC-13 (see curves and values below)
– Max. switching frequency	Cycles/h	–	3600
– Load factor		–	0.5
Connecting data of contact blocks			
Connecting terminals		M3 x 0.5 screw with Philips head	M3.5 (+,-) pozidriv 2 screw with cable clamp
Connecting capacity	1 or 2 x mm ² / AWG	–	0.5 mm ² / AWG 20 to 2.5 mm ² / AWG 14
Terminal marking		refer to contact block	According to EN 50013

Electrical durability for AC-15 utilization category

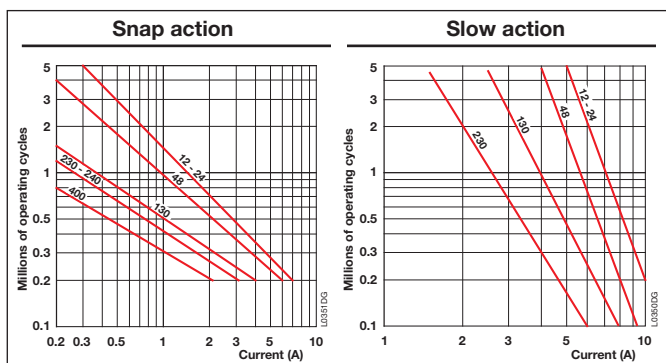

Electrical durability for DC-13 utilization category

	Snap action	Slow action
Power breaking for a durability of 5 million operating cycles		
Voltage 24 V	9.5 W	12 W
Voltage 48 V	6.8 W	9 W
Voltage 110 V	3.6 W	6 W



ABB France

Automation Products Division

Export Department

10, rue Ampère Z.I. - B.P. 114

F-69685 Chassieu cedex / France

Tel. : +33 (0) 4 7222 1722

Fax : +33 (0) 4 7222 1935

<http://www.abb.com/lowvoltage>

As part of its on-going product improvement, ABB reserves the right to modify the characteristics or the products described in this document.

The information given is not-contractual. For further details please contact the ABB company marketing these products in your country.