

WAGO-I/O-SYSTEM 750

4DI 24V AC/DC 20ms

750-415

4-Channel Digital Input Module 24 V AC/DC, 2-conductor connection

Version 1.1.1

© 2014 by WAGO Kontakttechnik GmbH & Co. KG
All rights reserved.

WAGO Kontakttechnik GmbH & Co. KG

Hansastraße 27
D-32423 Minden

Phone: +49 (0) 571/8 87 – 0
Fax: +49 (0) 571/8 87 – 1 69

E-Mail: info@wago.com

Web: <http://www.wago.com>

Technical Support

Phone: +49 (0) 571/8 87 – 5 55
Fax: +49 (0) 571/8 87 – 85 55

E-Mail: support@wago.com

Every conceivable measure has been taken to ensure the accuracy and completeness of this documentation. However, as errors can never be fully excluded, we always appreciate any information or suggestions for improving the documentation.

E-Mail: documentation@wago.com

We wish to point out that the software and hardware terms as well as the trademarks of companies used and/or mentioned in the present manual are generally protected by trademark or patent.

Table of Contents

Table of Contents	3
1 Notes about this Documentation	5
1.1 Validity of this Documentation.....	5
1.2 Copyright.....	5
1.3 Symbols.....	6
1.4 Number Notation.....	8
1.5 Font Conventions.....	8
2 Important Notes	9
2.1 Legal Bases.....	9
2.1.1 Subject to Changes.....	9
2.1.2 Personnel Qualifications.....	9
2.1.3 Use of the 750 Series in Compliance with Underlying Provisions.....	9
2.1.4 Technical Condition of Specified Devices.....	10
2.2 Safety Advice (Precautions).....	11
3 Device Description	13
3.1 View.....	14
3.2 Connectors.....	15
3.2.1 Data Contacts/Internal Bus.....	15
3.2.2 CAGE CLAMP® Connectors.....	16
3.3 Display Elements.....	17
3.4 Schematic Diagram.....	18
3.5 Technical Data.....	19
3.5.1 Device data.....	19
3.5.2 Supply.....	19
3.5.3 Communication.....	19
3.5.4 Inputs.....	19
3.5.5 Connection Type.....	20
3.5.6 Climatic Environmental Conditions.....	20
3.6 Approvals.....	21
3.7 Standards and Guidelines.....	22
4 Process Image	23
5 Mounting	24
5.1 Mounting Sequence.....	24
5.2 Inserting and Removing Devices.....	25
5.2.1 Inserting I/O Module.....	25
5.2.2 Removing the I/O Module.....	26
6 Connect Devices	27
6.1 Connecting a Conductor to the CAGE CLAMP®.....	27
6.2 Connection Examples.....	28
7 Use in Hazardous Environments	29
7.1 Marking Configuration Examples.....	30
7.1.1 Marking for Europe according to ATEX and IEC-Ex.....	30
7.1.2 Marking for America according to NEC 500.....	35

7.2	Installation Regulations.....	36
7.2.1	Special conditions for safe use (ATEX Certificate TÜV 07 ATEX 554086 X).....	37
7.2.2	Special conditions for safe use (ATEX Certificate TÜV 12 ATEX 106032 X).....	38
7.2.3	Special conditions for safe use (IEC-Ex Certificate TUN 09.0001 X).....	39
7.2.4	Special conditions for safe use (IEC-Ex Certificate IECEx TUN 12.0039 X).....	40
7.2.5	ANSI/ISA 12.12.01	41
	List of Figures	42
	List of Tables.....	43

1 Notes about this Documentation

Note



Keep this documentation!

The operating instructions are part of the product and shall be kept for the entire lifetime of the device. They shall be transferred to each subsequent owner or user of the device. Care must also be taken to ensure that any supplement to these instructions are included, if applicable.

1.1 Validity of this Documentation

This documentation is only applicable to the I/O module 750-415 (4DI 24V AC/DC 20ms) of the WAGO-I/O-SYSTEM 750 series.

The I/O module 750-415 shall only be installed and operated according to the instructions in this manual and in the manual for the used fieldbus coupler/controller.

NOTICE

Consider power layout of the WAGO-I/O-SYSTEM 750!

In addition to these operating instructions, you will also need the manual for the used fieldbus coupler/controller, which can be downloaded at www.wago.com. There, you can obtain important information including information on electrical isolation, system power and supply specifications.

1.2 Copyright

This Manual, including all figures and illustrations, is copyright-protected. Any further use of this Manual by third parties that violate pertinent copyright provisions is prohibited. Reproduction, translation, electronic and phototechnical filing/archiving (e.g., photocopying) as well as any amendments require the written consent of WAGO Kontakttechnik GmbH & Co. KG, Minden, Germany. Non-observance will involve the right to assert damage claims.

1.3 Symbols

 **DANGER****Personal Injury!**

Indicates a high-risk, imminently hazardous situation which, if not avoided, will result in death or serious injury.

 **DANGER****Personal Injury Caused by Electric Current!**

Indicates a high-risk, imminently hazardous situation which, if not avoided, will result in death or serious injury.

 **WARNING****Personal Injury!**

Indicates a moderate-risk, potentially hazardous situation which, if not avoided, could result in death or serious injury.

 **CAUTION****Personal Injury!**

Indicates a low-risk, potentially hazardous situation which, if not avoided, may result in minor or moderate injury.

NOTICE**Damage to Property!**

Indicates a potentially hazardous situation which, if not avoided, may result in damage to property.

NOTICE**Damage to Property Caused by Electrostatic Discharge (ESD)!**

Indicates a potentially hazardous situation which, if not avoided, may result in damage to property.

Note**Important Note!**

Indicates a potential malfunction which, if not avoided, however, will not result in damage to property.



Information

Additional Information:

Refers to additional information which is not an integral part of this documentation (e.g., the Internet).

1.4 Number Notation

Table 1: Number notation

Number code	Example	Note
Decimal	100	Normal notation
Hexadecimal	0x64	C notation
Binary	'100' '0110.0100'	In quotation marks, nibble separated with dots (.)

1.5 Font Conventions

Table 2: Font conventions

Font type	Indicates
<i>italic</i>	Names of paths and data files are marked in italic-type. e.g.: <i>C:\Programme\WAGO-I/O-CHECK</i>
Menu	Menu items are marked in bold letters. e.g.: Save
>	A greater-than sign between two names means the selection of a menu item from a menu. e.g.: File > New
Input	Designation of input or optional fields are marked in bold letters, e.g.: Start of measurement range
“Value”	Input or selective values are marked in inverted commas. e.g.: Enter the value “4 mA” under Start of measurement range .
[Button]	Pushbuttons in dialog boxes are marked with bold letters in square brackets. e.g.: [Input]
[Key]	Keys are marked with bold letters in square brackets. e.g.: [F5]

2 Important Notes

This section includes an overall summary of the most important safety requirements and notes that are mentioned in each individual section. To protect your health and prevent damage to devices as well, it is imperative to read and carefully follow the safety guidelines.

2.1 Legal Bases

2.1.1 Subject to Changes

WAGO Kontakttechnik GmbH & Co. KG reserves the right to provide for any alterations or modifications that serve to increase the efficiency of technical progress. WAGO Kontakttechnik GmbH & Co. KG owns all rights arising from the granting of patents or from the legal protection of utility patents. Third-party products are always mentioned without any reference to patent rights. Thus, the existence of such rights cannot be excluded.

2.1.2 Personnel Qualifications

All sequences implemented on Series 750 devices may only be carried out by electrical specialists with sufficient knowledge in automation. The specialists must be familiar with the current norms and guidelines for the devices and automated environments.

All changes to the coupler or controller should always be carried out by qualified personnel with sufficient skills in PLC programming.

2.1.3 Use of the 750 Series in Compliance with Underlying Provisions

Couplers, controllers and I/O modules found in the modular WAGO-I/O-SYSTEM 750 receive digital and analog signals from sensors and transmit them to the actuators or higher-level control systems. Using programmable controllers, the signals can also be (pre-) processed.

The components have been developed for use in an environment that meets the IP20 protection class criteria. Protection against finger injury and solid impurities up to 12.5 mm diameter is assured; protection against water damage is not ensured. Unless otherwise specified, operation of the components in wet and dusty environments is prohibited.

Operating 750 Series components in home applications without further measures is only permitted if they meet the emission limits (emissions of interference) according to EN 61000-6-3. You will find the relevant information in the section on "WAGO-I/O-SYSTEM 750" → "System Description" → "Technical Data" in the manual for the used fieldbus coupler/controller.

Appropriate housing (per 94/9/EG) is required when operating the WAGO-I/O-SYSTEM 750 in hazardous environments. Please note that a prototype test certificate must be obtained that confirms the correct installation of the system in a housing or switch cabinet.

2.1.4 Technical Condition of Specified Devices

The components to be supplied Ex Works, are equipped with hardware and software configurations, which meet the individual application requirements. WAGO Kontakttechnik GmbH & Co. KG will be exempted from any liability in case of changes in hardware or software as well as to non-compliant usage of components.

Please send your request for modified and new hardware or software configurations directly to WAGO Kontakttechnik GmbH & Co. KG.

2.2 Safety Advice (Precautions)

For installing and operating purposes of the relevant device to your system the following safety precautions shall be observed:



DANGER

Do not work on components while energized!

All power sources to the device shall be switched off prior to performing any installation, repair or maintenance work.

DANGER

Installation only in appropriate housings, cabinets or in electrical operation rooms!

The WAGO-I/O-SYSTEM 750 and its components are an open system. As such, install the system and its components exclusively in appropriate housings, cabinets or in electrical operation rooms. Allow access to such equipment and fixtures to authorized, qualified staff only by means of specific keys or tools.

NOTICE

Replace defective or damaged devices!

Replace defective or damaged device/module (e.g., in the event of deformed contacts), since the long-term functionality of device/module involved can no longer be ensured.

NOTICE

Protect the components against materials having seeping and insulating properties!

The components are not resistant to materials having seeping and insulating properties such as: aerosols, silicones and triglycerides (found in some hand creams). If you cannot exclude that such materials will appear in the component environment, then install the components in an enclosure being resistant to the above-mentioned materials. Clean tools and materials are imperative for handling devices/modules.

NOTICE

Cleaning only with permitted materials!

Clean soiled contacts using oil-free compressed air or with ethyl alcohol and leather cloths.

NOTICE**Do not use any contact spray!**

Do not use any contact spray. The spray may impair contact area functionality in connection with contamination.

NOTICE**Do not reverse the polarity of connection lines!**

Avoid reverse polarity of data and power supply lines, as this may damage the devices involved.

NOTICE**Avoid electrostatic discharge!**

The devices are equipped with electronic components that you may destroy by electrostatic discharge when you touch. Pay attention while handling the devices to good grounding of the environment (persons, job and packing).

3 Device Description

The digital input module 750-415 receives control signals from digital field (e.g. of sensors, transmitters, switches or proximity switches).

The I/O module has 4 input channels, providing a direct connection to 2-wire sensors.

The sensors are connected to the following pair of CAGE CLAMP® terminals: DI 1 ... DI 4.

The assignment of the connections is described in the "Connections" section. Connection examples are shown in section "Connecting Devices" > "Connection Example(s)".

For AC/DC operation, the inputs have a bridge rectifier, a capacitor and a current limitation.

Each input channel has an RC noise rejection filter with a time constant of 20 ms.

A green LED indicates the switched status of each channel.

The meaning of the LEDs is described in the "Display Elements" section.

Note



Use a supply module!

Use a supply module for field-side power supply of downstream I/O modules.

The field voltage and the system voltage are electrically isolated from each other.

With consideration of the power jumper contacts, the individual modules can be arranged in any combination when configuring the fieldbus node. An arrangement in groups within the group of potentials is not necessary.

The I/O module 750-415 can be used with all fieldbus couplers/controllers of the WAGO-I/O-SYSTEM 750.

3.1 View

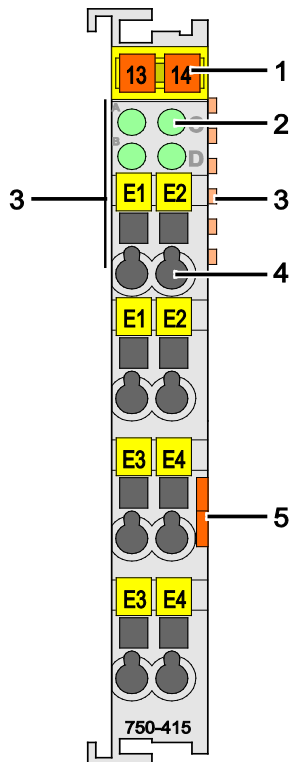

Figure 1: View

Table 1: Legend for the “View” figure

Pos.	Description	Details see section
1	Marking possibility with Mini-WSB	---
2	Status-LEDs	“Device Description” > “Display Elements”
3	Data contacts	“Device Description” > ”Connectors”
4	CAGE CLAMP® supplies	“Device Description” > ”Connectors”
5	Power jumper contacts	“Device Description” > ”Connectors”
6	Release tab	“Mounting” > ”Inserting and Removing Devices”

3.2 Connectors

3.2.1 Data Contacts/Internal Bus

Communication between the coupler/controller and the I/O modules as well as the system supply of the I/O modules is carried out via the internal bus. It is comprised of 6 data contacts, which are available as self-cleaning gold spring contacts.

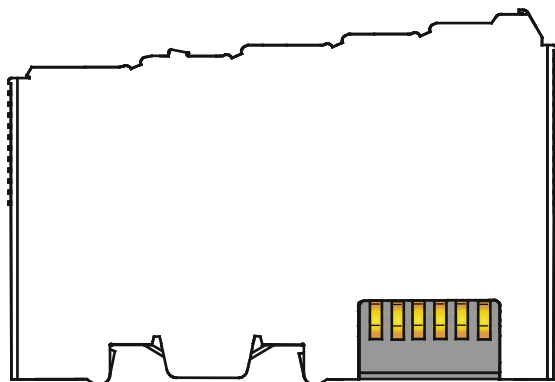

Figure 2: Data contacts

NOTICE

Do not place the I/O modules on the gold spring contacts!

Do not place the I/O modules on the gold spring contacts in order to avoid soiling or scratching!

NOTICE



Ensure that the environment is well grounded!

The modules are equipped with electronic components that may be destroyed by electrostatic discharge. When handling the modules, ensure that the environment (persons, workplace and packing) is well grounded. Avoid touching conductive components, e.g. data contacts.

3.2.2 CAGE CLAMP® Connectors

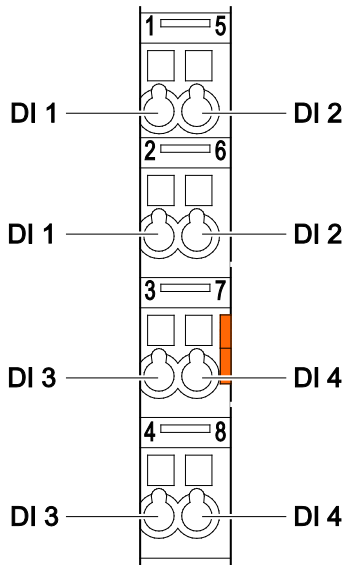

Figure 3: CAGE CLAMP® Connectors

Table 3: Legend for the “CAGE CLAMP® Connectors“ figure

Channel	Designation	Connector	Function
1	DI 1	1	Input DI 1: Signal voltage
	DI 1	2	Input DI 1: Signal voltage
2	DI 2	5	Input DI 2: Signal voltage
	DI 2	6	Input DI 2: Signal voltage
3	DI 3	3	Input DI 3: Signal voltage
	DI 3	4	Input DI 3: Signal voltage
4	DI 4	7	Input DI 4: Signal voltage
	DI 4	8	Input DI 4: Signal voltage

3.3 Display Elements

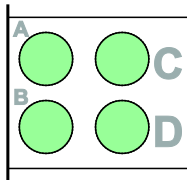

Figure 4: Display elements

Table 4: Legend for the “Display elements“ figure

Channel	Designation	LED	State	Function
1	Status DI 1	A	Off	Input DI 1: Signal voltage „0“
			Green	Input DI 1: Signal voltage „1“
2	Status DI 2	C	Off	Input DI 2: Signal voltage „0“
			Green	Input DI 2: Signal voltage „1“
3	Status DI 3	B	Off	Input DI 3: Signal voltage „0“
			Green	Input DI 3: Signal voltage „1“
4	Status DI 4	D	Off	Input DI 4: Signal voltage „0“
			Green	Input DI 4: Signal voltage „1“

3.4 Schematic Diagram

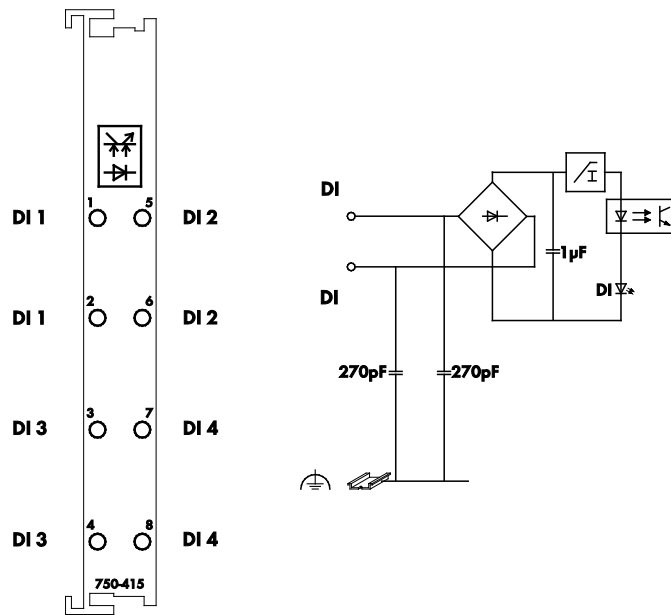

Figure 5: Schematic diagram

3.5 Technical Data

3.5.1 Device data

Table 5: Technical data – device

Width	12 mm
Height (from upper edge of 35 DIN rail)	64 mm
Depth	100 mm
Weight	approx. 49.5 g

3.5.2 Supply

Table 2: Technical data – supply

Voltage supply	Via system voltage terminal bus (5 V DC)
Current consumption _{typ.} (internal)	10 mA
Isolation (Peak value)	500 V System/Supply 50 V channel/channel

3.5.3 Communication

Table 3: Technical data – communication

Internal bit width (Terminal bus)	4 bit in
-----------------------------------	----------

3.5.4 Inputs

Table 4: Technical data – inputs

No. of inputs	4
Signal voltage	-3 V ... +30 V DC; 0 V .. 27 V AC
Signal voltage (0)	-3 V ... +5 V DC; 0 V .. 5 V AC
Signal voltage (1)	11 V ... 30 V DC; 10 V .. 27 V AC
Input filter	20 ms
Input current _{typ.}	7.5 mA DC, 9.5 mA AC

3.5.5 Connection Type

Table 6: Technical Data – Field Wiring

Wire connection	CAGE CLAMP®
Cross section	0.08 mm ² ... 2.5 mm ² , AWG 28 ... 14
Stripped lengths	8 mm ... 9 mm / 0.33 in

Table 7: Technical Data – Power Jumper Contacts

Power jumper contacts	blade/spring contact, self-cleaning
Voltage drop at I _{max.}	< 1 V/64 modules

Table 8: Technical Data – Internal Bus

Data contacts	slide contact, hard gold plated, self-cleaning
---------------	--

3.5.6 Climatic Environmental Conditions

Table 9: Technical Data - Climatic environmental conditions

Operating temperature range	0 °C ... 55 °C
Storage temperature range	-25 °C ... +85 °C
Relative humidity without condensation	max. 95 %
Resistance to harmful substances	Acc. to IEC 60068-2-42 and IEC 60068-2-43
Maximum pollutant concentration at relative humidity < 75%	SO ₂ ≤ 25 ppm H ₂ S ≤ 10 ppm
Special conditions	Ensure that additional measures for components are taken, which are used in an environment involving: – dust, caustic vapors or gases – ionizing radiation

3.6 Approvals

Information



More Information about Approvals

Detailed references to the approvals are listed in the document "Overview Approvals **WAGO-I/O-SYSTEM 750**", which you can find via the internet under: www.wago.com → Documentation → WAGO-I/O-SYSTEM 750 → System Description.

The following approvals have been granted to the basic version of 750-415 I/O modules:

 Conformity Marking

 cUL_{US} UL508

The following Ex approvals have been granted to the basic version of 750-415 I/O modules:

TÜV 07 ATEX 554086 X



I M2 Ex d I Mb
II 3 G Ex nA IIC T4 Gc
II 3 D Ex tc IIIC T135°C Dc

Ambient temperature range: $0\text{ °C} \leq T_a \leq +60\text{ °C}$

IECE_x TUN 09.0001 X

Ex d I Mb
Ex nA IIC T4 Gc
Ex tc IIIC T135°C Dc

Ambient temperature range: $0\text{ °C} \leq T_a \leq +60\text{ °C}$



cUL_{US} ANSI/ISA 12.12.01
Class I, Div2 ABCD T4

Brasilian- TUEV 12.1297 X
Ex Ex nA IIC T4 Gc

The following ship approvals have been granted to 750-415 I/O modules:



ABS (American Bureau of Shipping)



BV (Bureau Veritas)



DNV (Det Norske Veritas) Class B



GL (Germanischer Lloyd) Cat. A, B, C, D (EMC 1)



KR (Korean Register of Shipping)



LR (Lloyd's Register) Env. 1, 2, 3, 4



NKK (Nippon Kaiji Kyokai)



PRS (Polski Rejestr Statków)



RINA (Registro Italiano Navale)

3.7 Standards and Guidelines

750-415 I/O modules meet the following requirements on emission and immunity of interference:

EMC CE-Immunity to interference	acc. to EN 61000-6-2: 2005
EMC CE-Emission of interference	acc. to EN 61000-6-4: 2007
EMC marine applications-Immunity to interference	acc. to Germanischer Lloyd (2003)
EMC marine applications-Emission of interference	acc. to Germanischer Lloyd (2003)

4 Process Image

Note



Mapping of process data in the process image of fieldbus systems

The representation of the process data of some I/O modules or their variations in the process image depends on the fieldbus coupler/controller used. Please take this information from the section "Fieldbus Specific Design of the Process Data" included in the description concerning the process image of the corresponding coupler/controller.

Table 10: Input bits

		Bit 3	Bit 2	Bit 1	Bit 0
		DI 4	DI 3	DI 2	DI 1
DI 1	Signal state DI 1 – Digital input channel 1				
DI 2	Signal state DI 2 – Digital input channel 2				
DI 3	Signal state DI 3 – Digital input channel 3				
DI 4	Signal state DI 4 – Digital input channel 4				

5 Mounting

5.1 Mounting Sequence

All system components can be snapped directly on a carrier rail in accordance with the European standard EN 50022 (DIN 35).

The reliable positioning and connection is made using a tongue and groove system. Due to the automatic locking, the individual components are securely seated on the rail after installation.

Starting with the coupler/controller, the I/O modules are mounted adjacent to each other according to the project design. Errors in the design of the node in terms of the potential groups (connection via the power contacts) are recognized, as the I/O modules with power contacts (male contacts) cannot be linked to I/O modules with fewer power contacts.

CAUTION

Risk of injury due to sharp-edged male contacts!

The male contacts are sharp-edged. Handle the module carefully to prevent injury.

NOTICE

Insert I/O modules only from the proper directions!

All I/O modules feature grooves for power jumper contacts on the right side. For some I/O modules, the grooves are closed on the top. Therefore, I/O modules featuring a power jumper contact on the left side cannot be snapped from the top. This mechanical coding helps to avoid configuration errors, which may destroy the components. Therefore, insert I/O modules only from the right and from the top.

Note



Don't forget the bus end module!

Always plug a bus end module 750-600 onto the end of the fieldbus node! You must always use a bus end module at all fieldbus nodes with the WAGO I/O System 750 fieldbus couplers/controllers to guarantee proper data transfer.

5.2 Inserting and Removing Devices

NOTICE

Perform work on devices only if the system is de-energized!

Working on devices when the system is energized can damage the devices. Therefore, turn off the power supply before working on the devices.

5.2.1 Inserting I/O Module

1. Position the I/O module so that the tongue and groove joints to the fieldbus coupler/controller or to the previous or possibly subsequent I/O module are engaged.

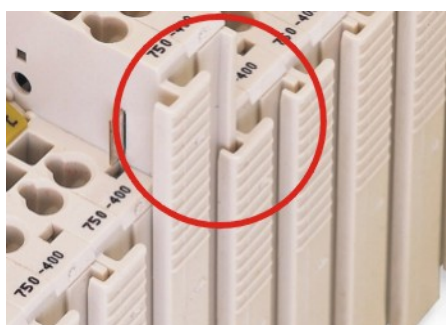

Figure 6: Insert I/O module (sample)

2. Press the I/O module into the assembly until the I/O module snaps into the carrier rail.

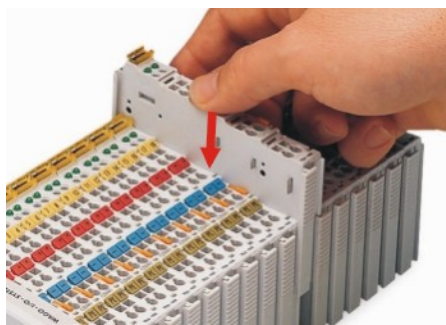

Figure 7: Snap the I/O module into place (sample)

With the I/O module snapped in place, the electrical connections for the data contacts and power contacts (if any) to the fieldbus coupler/controller or to the previous or possibly subsequent I/O module are established.

5.2.2 Removing the I/O Module

1. Remove the I/O module from the assembly by pulling the release tab.

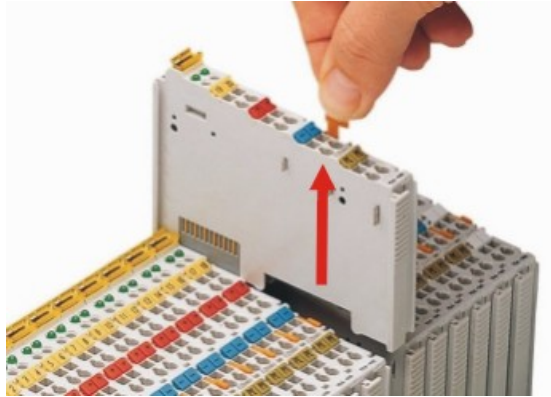

Figure 8: Removing the I/O module (sample)

Electrical connections for data or power contacts are disconnected when removing the I/O module.

6 Connect Devices

6.1 Connecting a Conductor to the CAGE CLAMP®

The WAGO CAGE CLAMP® connection is appropriate for solid, stranded and finely stranded conductors.

Note



Only connect one conductor to each CAGE CLAMP® connection!

Only one conductor may be connected to each CAGE CLAMP® connection.

Do not connect more than one conductor at one single connection!

If more than one conductor must be routed to one connection, these must be connected in an up-circuit wiring assembly, for example using WAGO feed-through terminals.

Exception:

If it is unavoidable to jointly connect 2 conductors, then you must use a ferrule to join the wires together. The following ferrules can be used:

Length	8 mm
Nominal cross section _{max.}	1 mm ² for 2 conductors with 0.5 mm ² each
WAGO Product	216-103 or products with comparable properties.

1. To open the CAGE CLAMP® insert the actuating tool into the opening above the connection.
2. Insert the conductor into the corresponding connection opening.
3. To close the CAGE CLAMP® simply remove the tool - the conductor is then clamped firmly in place.

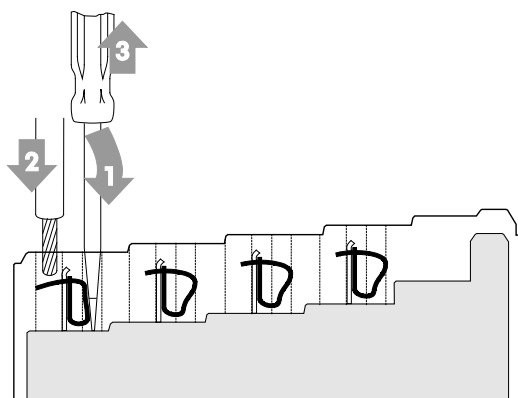

Figure 9: Connecting a conductor to a CAGE CLAMP®

6.2 Connection Examples

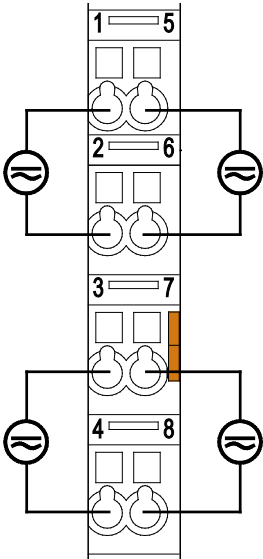

Figure 10: Connecting diagrams – 2-conductor connection

7 Use in Hazardous Environments

The **WAGO-I/O-SYSTEM 750** (electrical equipment) is designed for use in Zone 2 hazardous areas.

The following sections include both the general identification of components (devices) and the installation regulations to be observed. The individual subsections of the "Installation Regulations" section must be taken into account if the I/O module has the required approval or is subject to the range of application of the ATEX directive.

7.1 Marking Configuration Examples

7.1.1 Marking for Europe according to ATEX and IEC-Ex

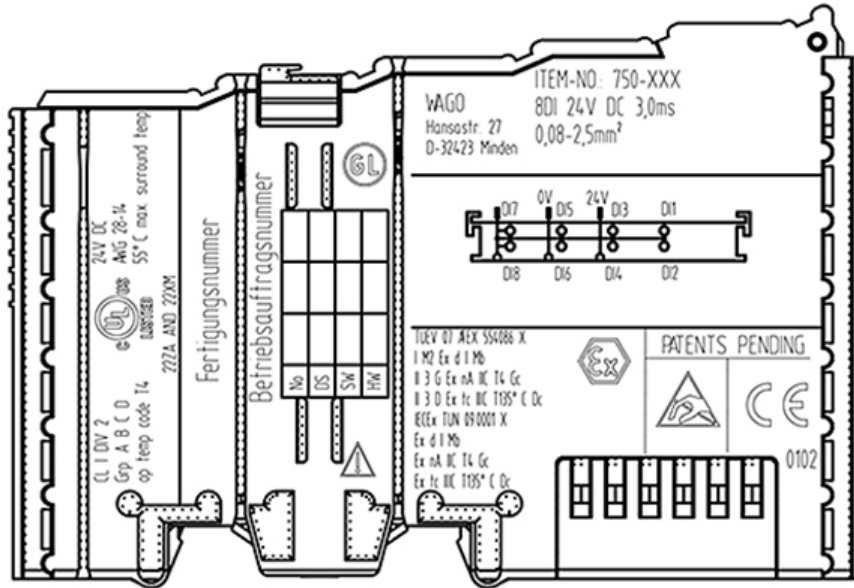

Figure 11: Side marking example for approved I/O modules according to ATEX and IECEx

TUEV 07 AEX 554086 X
 I M2 Ex d I Mb
 II 3 G Ex nA IIC T4 Gc
 II 3 D Ex tc IIC T135° C Dc
 IECEX TUN 09.0001 X
 Ex d I Mb
 Ex nA IIC T4 Gc
 Ex tc IIC T135° C Dc



Figure 12: Printing Text detail – Marking example for approved I/O modules according to ATEX and IECEx.

Table 11: Description of marking example for approved I/O modules according to ATEX and IECEx

Printing on Text	Description
TÜV 07 ATEX 554086 X IECEx TUN 09.0001 X	Approving authority and certificate numbers
Dust	
II	Equipment group: All except mining
3D	Category 3 (Zone 22)
Ex	Explosion protection mark
tc Dc	Type of protection and equipment protection level (EPL): protection by enclosure
IIIC	Explosion group of dust
T 135°C	Max. surface temperature of the enclosure (without a dust layer)
Mining	
I	Equipment group: Mining
M2	Category: High level of protection
Ex	Explosion protection mark
d Mb	Type of protection and equipment protection level (EPL): Flameproof enclosure
I	Explosion group for electrical equipment for mines susceptible to firedamp
Gases	
II	Equipment group: All except mining
3G	Category 3 (Zone 2)
Ex	Explosion protection mark
nA Gc	Type of protection and equipment protection level (EPL): Non-sparking equipment
nC Gc	Type of protection and equipment protection level (EPL): Sparking apparatus with protected contacts. A device which is so constructed that the external atmosphere cannot gain access to the interior
IIIC	Explosion group of gas and vapours
T4	Temperature class: Max. surface temperature 135°C

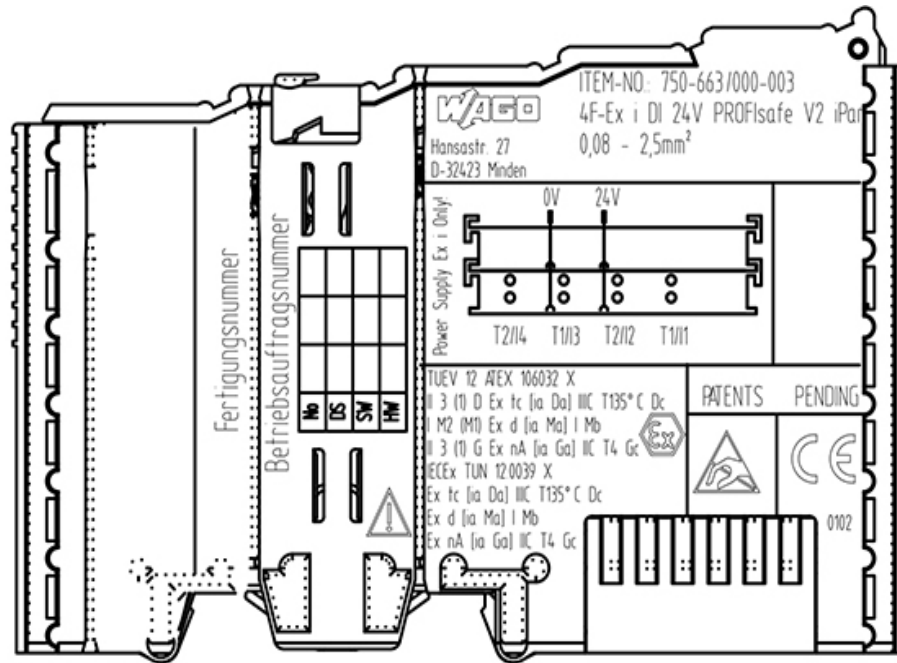

Figure 13: Side marking example for approved Ex i I/O modules according to ATEX and IECEx.

TUEV 12 ATEX 106032 X
 II 3 (1) D Ex tc [ia Da] IIC T135° C Dc
 I M2 (M1) Ex d [ia Ma] I Mb
 II 3 (1) G Ex nA [ia Ga] IIC T4 Gc 
 IECEx TUN 12.0039 X
 Ex tc [ia Da] IIC T135° C Dc
 Ex d [ia Ma] I Mb
 Ex nA [ia Ga] IIC T4 Gc

Figure 14: Text detail – Marking example for approved Ex i I/O modules according to ATEX and IECEx.

Table 12: Description of marking example for approved Ex i I/O modules according to ATEX and IECEx

Inscription text	Description
TÜV 07 ATEX 554086 X IECEx TUN 09.0001X	Approving authority and certificate numbers
TÜV 12 ATEX 106032 X IECEx TUN 12.0039 X	
Dust	
II	Equipment group: All except mining
3(1)D	Category 3 (Zone 22) equipment containing a safety device for a category 1 (Zone 20) equipment
3(2)D	Category 3 (Zone 22) equipment containing a safety device for a category 2 (Zone 21) equipment
Ex	Explosion protection mark
tc Dc	Type of protection and equipment protection level (EPL): protection by enclosure
[ia Da]	Type of protection and equipment protection level (EPL): associated apparatus with intrinsic safety circuits for use in Zone 20
[ib Db]	Type of protection and equipment protection level (EPL): associated apparatus with intrinsic safety circuits for use in Zone 21
IIIC	Explosion group of dust
T 135°C	Max. surface temperature of the enclosure (without a dust layer)
Mining	
I	Equipment Group: Mining
M2 (M1)	Category: High level of protection with electrical circuits which present a very high level of protection
Ex d Mb	Explosion protection mark with Type of protection and equipment protection level (EPL): Flameproof enclosure
[ia Ma]	Type of protection and equipment protection level (EPL): associated apparatus with intrinsic safety electrical circuits
I	Explosion group for electrical equipment for mines susceptible to firedamp

Table 12: Description of marking example for approved Ex i I/O modules according to ATEX and IECEx

Gases	
II	Equipment group: All except mining
3(1)G	Category 3 (Zone 2) equipment containing a safety device for a category 1 (Zone 0) equipment
3(2)G	Category 3 (Zone 2) equipment containing a safety device for a category 2 (Zone 1) equipment
Ex	Explosion protection mark
nA Gc	Type of protection and equipment protection level (EPL): Non-sparking equipment
[ia Ga]	Type of protection and equipment protection level (EPL): associated apparatus with intrinsic safety circuits for use in Zone 0
[ia Gb]	Type of protection and equipment protection level (EPL): associated apparatus with intrinsic safety circuits for use in Zone 1
IIC	Explosion group of gas and vapours
T4	Temperature class: Max. surface temperature 135°C

7.1.2 Marking for America according to NEC 500

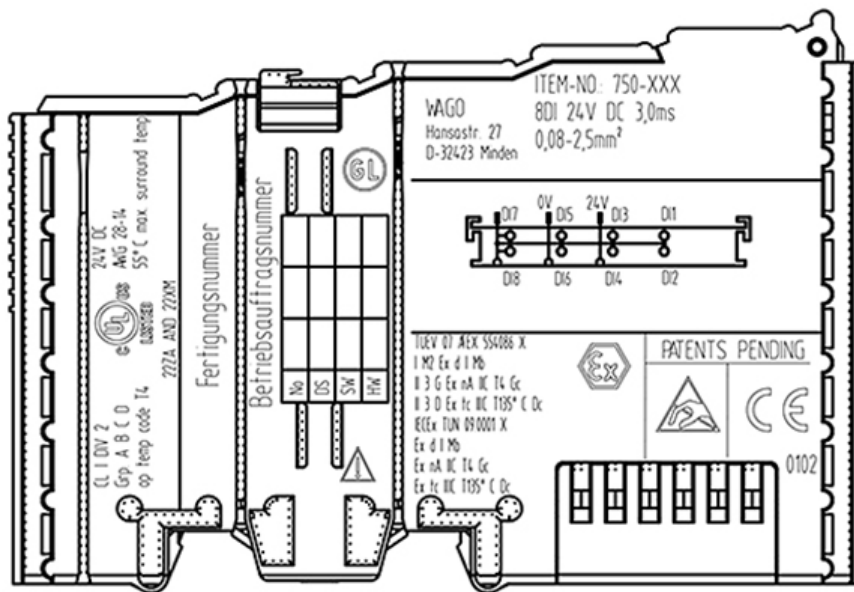

Figure 15: Side marking example for I/O modules according to NEC 500

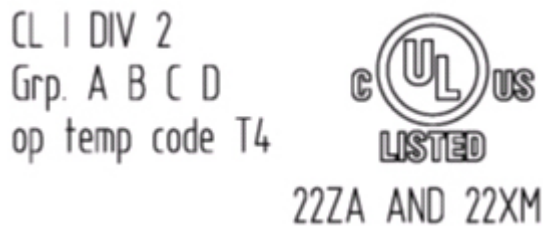

Figure 16: Text detail – Marking example for approved I/O modules according to NEC 500

Table 13: Description of marking example for approved I/O modules according to NEC 500

Printing on Text	Description
CL I	Explosion protection group (condition of use category)
DIV 2	Area of application
Grp. ABCD	Explosion group (gas group)
Op temp code T4	Temperature class

7.2 Installation Regulations

For the installation and operation of electrical equipment in hazardous areas, the valid national and international rules and regulations which are applicable at the installation location must be carefully followed.

7.2.1 Special conditions for safe use (ATEX Certificate TÜV 07 ATEX 554086 X)

1. For use as Gc- or Dc-apparatus (in zone 2 or 22) the Field bus Independent I/O Modules WAGO-I/O-SYSTEM 750-*** shall be erected in an enclosure that fulfils the requirements of the applicable standards (see the marking) EN 60079-0, EN 60079-11, EN 60079-15 and EN 60079-31. For use as group I electrical apparatus M2 the apparatus shall be erected in an enclosure that ensures a sufficient protection according to EN 60079-0 and EN 60079-1 and the degree of protection IP64. The compliance of these requirements and the correct installation into an enclosure or a control cabinet of the devices shall be certified by an ExNB.
2. Measures have to be taken outside of the device that the rating voltage is not being exceeded of more than 40 % because of transient disturbances.
3. Dip-switches, binary-switches and potentiometers, connected to the module may only be actuated when explosive atmosphere can be excluded.
4. The connecting and disconnecting of the non-intrinsically safe circuits is only permitted during installation, for maintenance or for repair purposes. The temporal coincidence of explosion hazardous atmosphere and installation, maintenance resp. repair purposes shall be excluded. This is although and in particular valid for the interfaces “Memory-Card”, “USB”, “Fieldbus connection”, “Configuration and programming interface”, “antenna socket”, “D-Sub”, “DVI-port” and the “Ethernet interface”. These interfaces are not energy limited or intrinsically safe circuits. An operating of those circuits is in the behalf of the operator.
5. For the types 750-606, 750-625/000-001, 750-487/003-000, 750-484 and 750-633 the following shall be considered: The Interface circuits shall be limited to overvoltage category I/II/III (non mains/mains circuits) as defined in EN 60664-1.
6. For replaceable fuses the following shall be considered: Do not remove or replace the fuse when the apparatus is energized.
7. The following warnings shall be placed nearby the unit:
WARNING – DO NOT REMOVE OR REPLACE FUSE WHEN ENERGIZED
WARNING – DO NOT SEPARATE WHEN ENERGIZED
WARNING – SEPARATE ONLY IN A NON-HAZARDOUS AREA

7.2.2 Special conditions for safe use (ATEX Certificate TÜV 12 ATEX 106032 X)

1. For use as Gc- or Dc-apparatus (in zone 2 or 22) the Field bus Independent I/O Modules WAGO-I/O-SYSTEM 750-*** Ex i shall be erected in an enclosure that fulfils the requirements of the applicable standards (see the marking) EN 60079-0, EN 60079-11, EN 60079-15 and EN 60079-31. For use as group I electrical apparatus M2 the apparatus shall be erected in an enclosure that ensures a sufficient protection according to EN 60079-0 and EN 60079-1 and the degree of protection IP64. The compliance of these requirements and the correct installation into an enclosure or a control cabinet of the devices shall be certified by an ExNB.
2. Measures have to be taken outside of the device that the rating voltage is not being exceeded of more than 40 % because of transient disturbances.
3. The connecting and disconnecting of the non-intrinsically safe circuits is only permitted during installation, for maintenance or for repair purposes. The temporal coincidence of explosion hazardous atmosphere and installation, maintenance resp. repair purposes shall be excluded.
4. For the type the following shall be considered: The Interface circuits shall be limited to overvoltage category I/II/III (non mains/mains circuits) as defined in EN 60664-1.

7.2.3 Special conditions for safe use (IEC-Ex Certificate TUN 09.0001 X)

1. For use as Gc- or Dc-apparatus (in zone 2 or 22) the Field bus Independent I/O Modules WAGO-I/O-SYSTEM 750-*** shall be erected in an enclosure that fulfils the requirements of the applicable standards (see the marking) IEC 60079-0, IEC 60079-11, IEC 60079-15 and IEC 60079-31. For use as group I electrical apparatus M2 the apparatus shall be erected in an enclosure that ensures a sufficient protection according to IEC 60079-0 and IEC 60079-1 and the degree of protection IP64. The compliance of these requirements and the correct installation into an enclosure or a control cabinet of the devices shall be certified by an ExCB.
2. Measures have to be taken outside of the device that the rating voltage is not being exceeded of more than 40 % because of transient disturbances.
3. DIP-switches, binary-switches and potentiometers, connected to the module may only be actuated when explosive atmosphere can be excluded.
4. The connecting and disconnecting of the non-intrinsically safe circuits is only permitted during installation, for maintenance or for repair purposes. The temporal coincidence of explosion hazardous atmosphere and installation, maintenance resp. repair purposes shall be excluded. This is although and in particular valid for the interfaces “Memory-Card”, “USB”, “Fieldbus connection”, “Configuration and programming interface”, “antenna socket”, “D-Sub”, “DVI-port” and the “Ethernet interface”. These interfaces are not energy limited or intrinsically safe circuits. An operating of those circuits is in the behalf of the operator.
5. For the types 750-606, 750-625/000-001, 750-487/003-000, 750-484 and 750-633 the following shall be considered: The Interface circuits shall be limited to overvoltage category I/II/III (non mains/mains circuits) as defined in IEC 60664-1.
6. For replaceable fuses the following shall be considered: Do not remove or replace the fuse when the apparatus is energized.
7. The following warnings shall be placed nearby the unit:
WARNING – DO NOT REMOVE OR REPLACE FUSE WHEN ENERGIZED
WARNING – DO NOT SEPARATE WHEN ENERGIZED
WARNING – SEPARATE ONLY IN A NON-HAZARDOUS AREA

7.2.4 Special conditions for safe use (IEC-Ex Certificate IECEx TUN 12.0039 X)

1. For use as Gc- or Dc-apparatus (in zone 2 or 22) the Field bus independent I/O Modules WAGO-I/O-SYSTEM 750-*** Ex i shall be erected in an enclosure that fulfils the requirements of the applicable standards (see the marking) IEC 60079-0, IEC 60079-11, IEC 60079-15, IEC 60079-31.
For use as group I electrical apparatus M2 the apparatus shall be erected in an enclosure that ensures a sufficient protection according to IEC 60079-0 and IEC 60079-1 and the degree of protection IP64.
The compliance of these requirements and the correct installation into an enclosure or a control cabinet of the devices shall be certified by an ExCB.
2. Measures have to be taken outside of the device that the rating voltage is not being exceeded of more than 40 % because of transient disturbances.
3. The connecting and disconnecting of the non-intrinsically safe circuits is only permitted during installation, for maintenance or for repair purposes.
The temporal coincidence of explosion hazardous atmosphere and installation, maintenance resp. repair purposes shall be excluded.
4. For the type the following shall be considered: The Interface circuits shall be limited to overvoltage category I/II/III (non mains/mains circuits) as defined in IEC 60664-1.

7.2.5 ANSI/ISA 12.12.01

- A. “This equipment is suitable for use in Class I, Division 2, Groups A, B, C, D or non-hazardous locations only.”
- B. “This equipment is to be fitted within tool-secured enclosures only.”
- C. “WARNING Explosion hazard - substitution of components may impair suitability for Class I, Div. 2.”
- D. “WARNING – Do not disconnect equipment unless power has been switched off or the area is known to be non-hazardous” has to be placed near each operator accessible connector and fuse holder.
- E. When a fuse is provided, the following information shall be provided: “A switch suitable for the location where the equipment is installed shall be provided to remove the power from the fuse.”
- F. For devices with EtherCAT/Ethernet connectors “Only for use in LAN, not for connection to telecommunication circuits.”
- G. “WARNING - Use Module 750-642 only with antenna module 758-910.”
- H. For Couplers/Controllers and Economy bus modules only: The instructions shall contain the following: “The configuration interface Service connector is for temporary connection only. Do not connect or disconnect unless the area is known to be non-hazardous. Connection or disconnection in an explosive atmosphere could result in an explosion.”
- I. Modules containing fuses only: “WARNING - Devices containing fuses must not be fitted into circuits subject to over loads, e.g. motor circuits.”
- J. Modules containing SD card reader sockets only: “WARNING - Do not connect or disconnect SD-Card while circuit is live unless the area is known to be free of ignitable concentrations of flammable gases or vapors.”

Information



Additional Information

Proof of certification is available on request. Also take note of the information given on the module technical information sheet. The Instruction Manual, containing these special conditions for safe use, must be readily available to the user.

List of Figures

Figure 1: View.....	14
Figure 2: Data contacts.....	15
Figure 3: CAGE CLAMP® Connectors.....	16
Figure 4: Display elements.....	17
Figure 5: Schematic diagram.....	18
Figure 6: Insert I/O module (sample).....	25
Figure 7: Snap the I/O module into place (sample).....	25
Figure 8: Removing the I/O module (sample).....	26
Figure 9: Connecting a conductor to a CAGE CLAMP®.....	27
Figure 10: Connecting diagrams – 2-conductor connection	28
Figure 11: Side marking example for approved I/O modules according to ATEX and IECEx.....	30
Figure 12: Printing Text detail – Marking example for approved I/O modules according to ATEX and IECEx.	30
Figure 13: Side marking example for approved Ex i I/O modules according to ATEX and IECEx.	32
Figure 14: Text detail – Marking example for approved Ex i I/O modules according to ATEX and IECEx.	32
Figure 15: Side marking example for I/O modules according to NEC 500	35
Figure 16: Text detail – Marking example for approved I/O modules according to NEC 500.....	35

List of Tables

Table 1: Number notation.....	8
Table 2: Font conventions	8
Table 3: Legend for the “CAGE CLAMP® Connectors“ figure	16
Table 4: Legend for the “Display elements“ figure	17
Table 5: Technical data – device.....	19
Table 6: Technical Data – Field Wiring.....	20
Table 7: Technical Data – Power Jumper Contacts	20
Table 8: Technical Data – Internal Bus.....	20
Table 9: Technical Data - Climatic environmental conditions.....	20
Table 10: Input bits.....	23
Table 11: Description of marking example for approved I/O modules according to ATEX and IECEx	31
Table 12: Description of marking example for approved Ex i I/O modules according to ATEX and IECEx	33
Table 13: Description of marking example for approved I/O modules according to NEC 500.....	35

WAGO Kontakttechnik GmbH & Co. KG
Postfach 2880 • D-32385 Minden
Hansastraße 27 • D-32423 Minden
Phone: +49/5 71/8 87 – 0
Fax: +49/5 71/8 87 – 1 69
E-Mail: info@wago.com
Internet: <http://www.wago.com>

