

## WAGO-I/O-SYSTEM 750

2DO 24V DC 2.0A

**750-502**

2-Channel Digital Output Module DC 24 V, short-circuit protected, high-side switching

Version 1.2.0

© 2011 by WAGO Kontakttechnik GmbH & Co. KG  
All rights reserved.

### **WAGO Kontakttechnik GmbH & Co. KG**

Hansastraße 27  
D-32423 Minden

Phone: +49 (0) 571/8 87 – 0  
Fax: +49 (0) 571/8 87 – 1 69

E-Mail: [info@wago.com](mailto:info@wago.com)

Web: <http://www.wago.com>

### **Technical Support**

Phone: +49 (0) 571/8 87 – 5 55  
Fax: +49 (0) 571/8 87 – 85 55

E-Mail: [support@wago.com](mailto:support@wago.com)

Every conceivable measure has been taken to ensure the accuracy and completeness of this documentation. However, as errors can never be fully excluded, we always appreciate any information or suggestions for improving the documentation.

E-Mail: [documentation@wago.com](mailto:documentation@wago.com)

We wish to point out that the software and hardware terms as well as the trademarks of companies used and/or mentioned in the present manual are generally protected by trademark or patent.

# Table of Contents

<b>1</b>	<b>Notes about this Documentation.....</b>	<b>5</b>
1.1	Validity of this Documentation.....	5
1.2	Copyright.....	5
1.3	Symbols.....	7
1.4	Number Notation.....	9
1.5	Font Conventions .....	9
<b>2</b>	<b>Important Notes .....</b>	<b>10</b>
2.1	Legal Bases .....	10
2.1.1	Subject to Changes .....	10
2.1.2	Personnel Qualifications.....	10
2.1.3	Use of the 750 Series in Compliance with Underlying Provisions ....	10
2.1.4	Technical Condition of Specified Devices.....	11
2.2	Safety Advice (Precautions).....	12
<b>3</b>	<b>Device Description .....</b>	<b>14</b>
3.1	View .....	16
3.2	Connectors.....	17
3.2.1	Data Contacts/Internal Bus.....	17
3.2.2	Power Contacts/Field Supply .....	18
3.2.3	CAGE CLAMP® Connections .....	19
3.3	Display Elements .....	20
3.4	Operating Elements.....	20
3.5	Schematic Diagram .....	21
3.6	Technical Data .....	22
3.6.1	Device Data .....	22
3.6.2	Power Supply.....	22
3.6.3	Communication .....	22
3.6.4	Outputs .....	22
3.7	Approvals .....	23
3.8	Standards and Guidelines.....	24
<b>4</b>	<b>Assembly .....</b>	<b>25</b>
4.1	Assembly Sequence .....	25
4.2	Inserting and Removing Devices .....	26
4.2.1	Inserting I/O Module .....	26
4.2.2	Removing the I/O Module.....	27
<b>5</b>	<b>Connect Devices .....</b>	<b>28</b>
5.1	Connecting a conductor to the CAGE CLAMP® .....	28
5.2	Connection Examples.....	29
5.2.1	2-Conductor Connection, ungrounded .....	29
5.2.2	2-Conductor Connection, grounded .....	29
5.2.3	3-Conductor Connection, ungrounded .....	30
5.2.4	3-Conductor Connection, grounded .....	30
<b>6</b>	<b>Process Image.....</b>	<b>31</b>

---

<b>7</b>	<b>Using Interference-Free Variations of I/O Modules in Safety Related Applications .....</b>	<b>32</b>
7.1	Important Notes.....	33
7.2	Connecting the IO Module to Safety Switching Devices or Safety Modules.....	34
7.2.1	General Structure.....	34
7.2.2	Examples of Connection.....	35
<b>8</b>	<b>Use in Hazardous Environments .....</b>	<b>37</b>
8.1	Identification .....	38
8.1.1	For Europe according to CENELEC and IEC .....	38
8.1.2	For America according to NEC 500.....	41
8.2	Installation Regulations.....	42
8.2.1	Special Conditions for Safe Operation of the ATEX and IEC Ex (acc. DEMKO 08 ATEX 142851X and IECEx PTB 07.0064).....	43
8.2.2	Special conditions for safe use (ATEX Certificate TÜV 07 ATEX 554086 X).....	44
8.2.3	Special conditions for safe use (IEC-Ex Certificate TUN 09.0001 X).....	45
8.2.4	ANSI/ISA 12.12.01 .....	46
	<b>List of Figures .....</b>	<b>47</b>
	<b>List of Tables.....</b>	<b>48</b>

# 1 Notes about this Documentation

## Note



### Keep this documentation!

The operating instructions are part of the product and shall be kept for the entire lifetime of the device. They shall be transferred to each subsequent owner or user of the device. Care must also be taken to ensure that any supplement to these instructions are included, if applicable.

## 1.1 Validity of this Documentation

This documentation is only applicable to the I/O module 750-502 (2DO 24V DC 2.0A) of the WAGO-I/O-SYSTEM 750 series and the variants listed in the table below.

Table 1: Variants

Item Number/Variant	Designation
750-502	2DO 24V DC 2.0A2DO 24V DC 2.0A
750-502/000-800	2DO 24V DC 2.0A/R

## Note



### Documentation Validity for Variants

Unless otherwise specified, basic version 750-502 data also applies to listed variants.

The I/O module 750-502 shall only be installed and operated according to the instructions in this manual and in the manual for the used fieldbus coupler/controller.

## NOTICE

### Consider power layout of the WAGO-I/O-SYSTEM 750!

In addition to these operating instructions, you will also need the manual for the used fieldbus coupler/controller, which can be downloaded at [www.wago.com](http://www.wago.com). There, you can obtain important information including information on electrical isolation, system power and supply specifications.

## 1.2 Copyright

This Manual, including all figures and illustrations, is copyright-protected. Any further use of this Manual by third parties that violate pertinent copyright provisions is prohibited. Reproduction, translation, electronic and phototechnical filing/archiving (e.g., photocopying) as well as any amendments require the written consent of WAGO Kontakttechnik GmbH & Co. KG, Minden, Germany. Non-observance will involve the right to assert damage claims.



## 1.3 Symbols

---

 **DANGER**

**Personal Injury!**

Indicates a high-risk, imminently hazardous situation which, if not avoided, will result in death or serious injury.

---

---

 **DANGER**

**Personal Injury Caused by Electric Current!**

Indicates a high-risk, imminently hazardous situation which, if not avoided, will result in death or serious injury.

---

---

 **WARNING**

**Personal Injury!**

Indicates a moderate-risk, potentially hazardous situation which, if not avoided, could result in death or serious injury.

---

---

 **CAUTION**

**Personal Injury!**

Indicates a low-risk, potentially hazardous situation which, if not avoided, may result in minor or moderate injury.

---

---

**NOTICE**

**Damage to Property!**

Indicates a potentially hazardous situation which, if not avoided, may result in damage to property.

---

---

**NOTICE**

**Damage to Property Caused by Electrostatic Discharge (ESD)!**

Indicates a potentially hazardous situation which, if not avoided, may result in damage to property.

---

---

**Note**

**Important Note!**

Indicates a potential malfunction which, if not avoided, however, will not result in damage to property.

---



## *Information*

**Additional Information:**

Refers to additional information which is not an integral part of this documentation (e.g., the Internet).

---



## 1.4 Number Notation

Table 2: Number Notation

Number code	Example	Note
Decimal	100	Normal notation
Hexadecimal	0x64	C notation
Binary	'100' '0110.0100'	In quotation marks, nibble separated with dots (.)

## 1.5 Font Conventions

Table 3: Font Conventions

Font type	Indicates
<i>italic</i>	Names of paths and data files are marked in italic-type. e.g.: <i>C:\Programme\WAGO-I/O-CHECK</i>
<b>Menu</b>	Menu items are marked in bold letters. e.g.: <b>Save</b>
>	A greater-than sign between two names means the selection of a menu item from a menu. e.g.: <b>File &gt; New</b>
<b>Input</b>	Designation of input or optional fields are marked in bold letters, e.g.: <b>Start of measurement range</b>
“Value”	Input or selective values are marked in inverted commas. e.g.: Enter the value “4 mA” under <b>Start of measurement range</b> .
<b>[Button]</b>	Pushbuttons in dialog boxes are marked with bold letters in square brackets. e.g.: <b>[Input]</b>
<b>[Key]</b>	Keys are marked with bold letters in square brackets. e.g.: <b>[F5]</b>

## 2 Important Notes

This section includes an overall summary of the most important safety requirements and notes that are mentioned in each individual section. To protect your health and prevent damage to devices as well, it is imperative to read and carefully follow the safety guidelines.

### 2.1 Legal Bases

#### 2.1.1 Subject to Changes

WAGO Kontakttechnik GmbH & Co. KG reserves the right to provide for any alterations or modifications that serve to increase the efficiency of technical progress. WAGO Kontakttechnik GmbH & Co. KG owns all rights arising from the granting of patents or from the legal protection of utility patents. Third-party products are always mentioned without any reference to patent rights. Thus, the existence of such rights cannot be excluded.

#### 2.1.2 Personnel Qualifications

All sequences implemented on Series 750 devices may only be carried out by electrical specialists with sufficient knowledge in automation. The specialists must be familiar with the current norms and guidelines for the devices and automated environments.

All changes to the coupler or controller should always be carried out by qualified personnel with sufficient skills in PLC programming.

#### 2.1.3 Use of the 750 Series in Compliance with Underlying Provisions

Couplers, controllers and I/O modules found in the modular WAGO-I/O-SYSTEM 750 receive digital and analog signals from sensors and transmit them to the actuators or higher-level control systems. Using programmable controllers, the signals can also be (pre-)processed.

The components have been developed for use in an environment that meets the IP20 protection class criteria. Protection against finger injury and solid impurities up to 12.5 mm diameter is assured; protection against water damage is not ensured. Unless otherwise specified, operation of the components in wet and dusty environments is prohibited.

Operating 750 Series components in home applications without further measures is only permitted if they meet the emission limits (emissions of interference) according to EN 61000-6-3. You will find the relevant information in the section on "WAGO-I/O-SYSTEM 750" → "System Description" → "Technical Data" in the manual for the used fieldbus coupler/controller.

Appropriate housing (per 94/9/EG) is required when operating the WAGO-I/O-SYSTEM 750 in hazardous environments. Please note that a prototype test certificate must be obtained that confirms the correct installation of the system in a housing or switch cabinet.

#### **2.1.4 Technical Condition of Specified Devices**

The components to be supplied Ex Works, are equipped with hardware and software configurations, which meet the individual application requirements. WAGO Kontakttechnik GmbH & Co. KG will be exempted from any liability in case of changes in hardware or software as well as to non-compliant usage of components.

Please send your request for modified and new hardware or software configurations directly to WAGO Kontakttechnik GmbH & Co. KG.

## 2.2 Safety Advice (Precautions)

For installing and operating purposes of the relevant device to your system the following safety precautions shall be observed:



### DANGER

#### **Do not work on components while energized!**

All power sources to the device shall be switched off prior to performing any installation, repair or maintenance work.

### DANGER

#### **Installation only in appropriate housings, cabinets or in electrical operation rooms!**

The WAGO-I/O-SYSTEM 750 and its components are an open system. As such, install the system and its components exclusively in appropriate housings, cabinets or in electrical operation rooms. Allow access to such equipment and fixtures to authorized, qualified staff only by means of specific keys or tools.

### NOTICE

#### **Replace defective or damaged devices!**

Replace defective or damaged device/module (e.g., in the event of deformed contacts), since the long-term functionality of device/module involved can no longer be ensured.

### NOTICE

#### **Protect the components against materials having seeping and insulating properties!**

The components are not resistant to materials having seeping and insulating properties such as: aerosols, silicones and triglycerides (found in some hand creams). If you cannot exclude that such materials will appear in the component environment, then install the components in an enclosure being resistant to the above-mentioned materials. Clean tools and materials are imperative for handling devices/modules.

### NOTICE

#### **Cleaning only with permitted materials!**

Clean soiled contacts using oil-free compressed air or with ethyl alcohol and leather cloths.

---

## NOTICE

**Do not use any contact spray!**

Do not use any contact spray. The spray may impair contact area functionality in connection with contamination.

---

---

## NOTICE

**Do not reverse the polarity of connection lines!**

Avoid reverse polarity of data and power supply lines, as this may damage the devices involved.

---

---

## NOTICE



**Avoid electrostatic discharge!**

The devices are equipped with electronic components that you may destroy by electrostatic discharge when you touch. Pay attention while handling the devices to good grounding of the environment (persons, job and packing).

---

### 3 Device Description

The 750-502 Digital Output Module transmits binary control signals from the automation device to the connected actuators (e.g., solenoid valves, contactors, transmitters, relays or other electrical loads).

The module has two output channels. Two actuators with ground (earth) wire may be directly connected to signal output DO 1, 0 V and PE (earth potential) or signal output DO 2, 0 V and PE.

The assignment of the connections is described in the "Connections" section. Connection examples are in the "Connecting devices - connection examples" section.

---

#### NOTICE

##### **Limit all induced voltage!**

The electronic components of the I/O module can be damaged by the induced voltage produced when inductive loads are de-activated.

An appropriate protection circuit, e.g., a recovery diode, must be installed in parallel to the load to limit this induced voltage.

---

The output channels are electrically short-circuit-protected.

The I/O module outputs provide high-side switching. If the signal status of an output channel is at "high" the 24V potential for field power will be switched to the appropriate output connection.

The supply voltage for the field side is derived from an adjacent supply module by means of power jumper contacts.

In case of the 2 A modules it is possible to operate single channels at higher load currents, however always verify that the total current does not exceed 4 A per module. This is possible to maximally 3 A per channel.

Example: 2x2A (standard); 1x3.0A; 1x1.0A (total current: 4 A).

---

#### NOTICE

##### **Provide for overload protection!**

Overloading can damage the electronic components of the I/O module.

A fused supply module (750-601) must be installed upstream of the I/O module to protect it against overloading!

---

A green LED indicates the switched status of each channel.

The meaning of the LEDs are described in the chapter „Display Elements“.

The I/O module receives the 24V voltage supply for the field level from an upstream I/O module or from the fieldbus coupler/controller via the power

contacts used as blade contacts. It then provides this potential to subsequent I/O modules via the power contacts used as spring contacts.

---

## NOTICE

### **Do not exceed maximum current via power contacts!**

The maximum current to flow through the power contacts is 10 A.

Greater currents can damage the power contacts.

When configuring the system, ensure that this current is not exceeded. If exceeded, an additional potential feed module must be used.

---

The field level and the system level are electrically isolated from one another.

---

## WARNING

### **Using in safety related applications!**

When using the I/O module ( 750-502 ) in safety-related applications, the instructions and connection examples in Section "Use in safety-related applications" are to be observed!

---

Any configuration of the output modules is possible when designing the fieldbus node. Grouping of module types is not necessary.

The I/O module 750-502 can be used with all fieldbus couplers/controllers of the WAGO-I/O-SYSTEM 750.

### 3.1 View

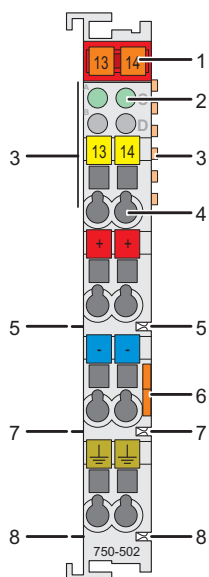

Figure 1: View

Table 4: Caption acc. to figure „Connections“

No.	Designation	Description	Details see chapter
1	---	Marking possibility with Mini-WSB	---
2	A, C	Status-LEDs	Technical manual“ > „Display elements“
3	---	Data contacts	„Technical manual“ > „Connections“
4	1 ... 8	CAGE CLAMP®-supply DO 1, DO 2, 24 V, 0 V and ground	„Technical manual“ > „Connections“
5	---	Power contacts +24 V	„Technical manual“ > „Connections“
6	---	Interlock link	„Assembly“ > „Insert and replace“
7	---	Power contacts 0 V	„Technical manual“ > „Connections“
8	---	Power contacts ground	„Technical manual“ > „Connections“



## 3.2 Connectors

### 3.2.1 Data Contacts/Internal Bus

Communication between the coupler/controller and the bus modules as well as the system supply of the bus modules is carried out via the internal bus. It is comprised of 6 data contacts, which are available as self-cleaning gold spring contacts.



Figure 2: Data contacts

---

### NOTICE

**Do not place the I/O modules on the gold spring contacts!**

Do not place the I/O modules on the gold spring contacts in order to avoid soiling or scratching!

---

---

### NOTICE



**Ensure that the environment is well grounded!**

The modules are equipped with electronic components that may be destroyed by electrostatic discharge. When handling the modules, ensure that the environment (persons, workplace and packing) is well grounded. Avoid touching conductive components, e.g. data contacts.

---

### 3.2.2 Power Contacts/Field Supply

## CAUTION

### Risk of injury due to sharp-edged male contacts!

The male contacts are sharp-edged. Handle the module carefully to prevent injury.

The I/O module 750-502 has 3 self-cleaning power jumper contacts that supply and transmit power for the field side. The contacts on the left side of the I/O module are designed as male contacts and the contacts on the right side as spring contacts.

Table 5: Power jumper contacts

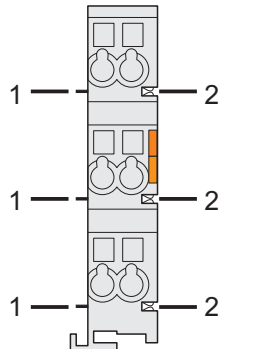
	Connection	Type	Number	Function
 <p>Fig 3: Power jumper contacts</p>	1	Blade contact	3	Infeed of the field supply voltage ( $U_V$ , 0 V and earth)
	2	Spring contact	3	Forwarding of the field supply voltage ( $U_V$ , 0 V and earth)

## NOTICE

### Do not exceed maximum current via power contacts!

The maximum current to flow through the power contacts is 10 A.

Greater currents can damage the power contacts.

When configuring the system, ensure that this current is not exceeded. If exceeded, an additional potential feed module must be used.

### 3.2.3 CAGE CLAMP® Connections

Table 6: Connections

	Connection	Channel	Designation	Function
<p>Figure 4: Connections</p>	1	1	DO 1	Output DO 1: Signal voltage
	5	2	DO 2	Output DO 2: Signal voltage
	2	1	24 V	Output DO 1: Field supply 24 V
	6	2	24 V	Output DO 2: Field supply 24 V
	3	1	0 V	Output DO 1: Field supply 0 V
	7	2	0 V	Output DO 2: Field supply 0 V
	4	1	Ground (Earth)	Output DO 1: Ground (Earth)
	8	2	Ground (Earth)	Output DO 2: Ground (Earth)
	Power contacts	-	+24 V	Field supply 24 V
	Power contacts	-	0 V	Field supply 0 V
	Power contacts	-	Ground (Earth)	Field supply Ground (Earth)

### 3.3 Display Elements

Table 7: Display elements

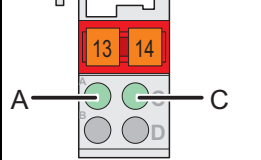
	LED	Channel	Designation	State	Function
 <p data-bbox="341 562 603 622">Figure 5: Display elements</p>	A	1	Status DO 1	off	Output DO 1: Signal voltage (0)
				green	Output DO 1: Signal voltage (1)
	C	2	Status DO 2	off	Output DO 2: Signal voltage (0)
				green	Output DO 2: Signal voltage (1)

### 3.4 Operating Elements

The I/O module 750-502 has no operating elements.

### 3.5 Schematic Diagram

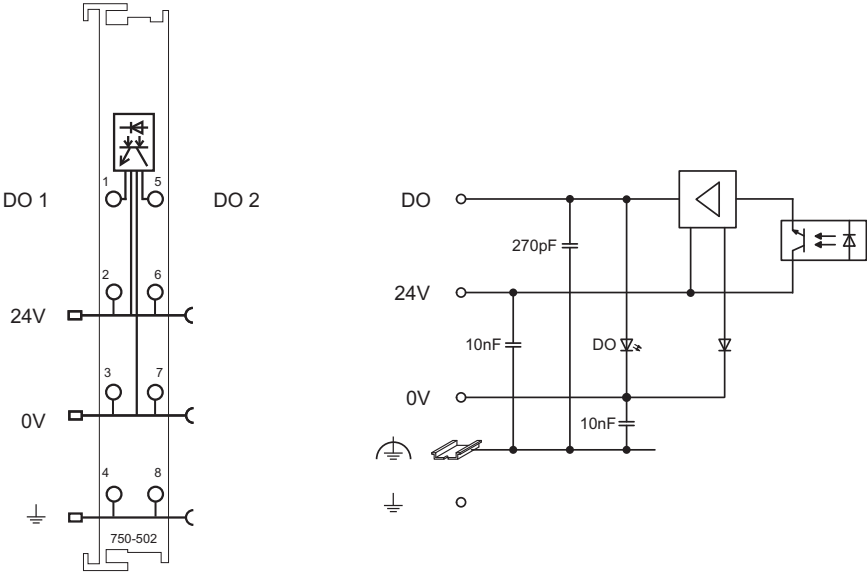

Figure 6: Schematic diagram

## 3.6 Technical Data

### 3.6.1 Device Data

Table 8: Technical data device

Width	48 mm
Height (from upper edge of 35 DIN rail)	64 mm
Depth	100 mm
Weight	ca. 55 g

### 3.6.2 Power Supply

Table 9: Technical data power supply

Voltage supply	Via system voltage terminal bus (5 V DC) and power jumper contacts (24 V DC)
Current consumption system voltage $_{max.}$ (5 V DC)	3.5 mA
Current consumption power jumper contacts $_{max.}$ (24 V DC)	15 mA + load
Voltage via power jumper contacts	DC 24 V (-25 % ... +30 %)
Current via power jumper contacts	10 A
Potential isolation	500 V (System /supply)

### 3.6.3 Communication

Table 10: Technical data communication

Data width (internal bus)	2 Bit out
---------------------------	-----------

### 3.6.4 Outputs

Table 11: Technical data outputs

Number of outputs	2
Output voltage	DC 24 V
Output current	2.0 A
Type of load	resistive, inductive, lamps
Reverse voltage protection	yes
Short-circuit limitation $_{typ. PWM}$	35 A (44 A peak)
Energy dissipation $W_{max.}$ (unique switching off)	1.7 J $L_{max.} = 2 W_{max.} / I^2$
Switching rate $_{max.}$	2.5 kHz

## 3.7 Approvals

### Information



#### More Information about Approvals

Detailed references to the approvals are listed in the document "Overview Approvals **WAGO-I/O-SYSTEM 750**", which you can find on the DVD "AUTOMATION Tools and Docs" (Item-No.: 0888-0412) or via the internet under: [www.wago.com](http://www.wago.com) → Service → Documentation → WAGO-I/O-SYSTEM 750 → System Description.

The following approvals have been granted to the basic version and all variations of 750-502 I/O modules:

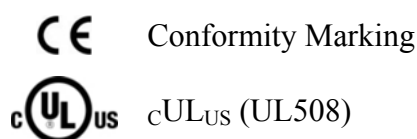

The following Ex approvals have been granted to the basic version of 750-502 I/O modules:

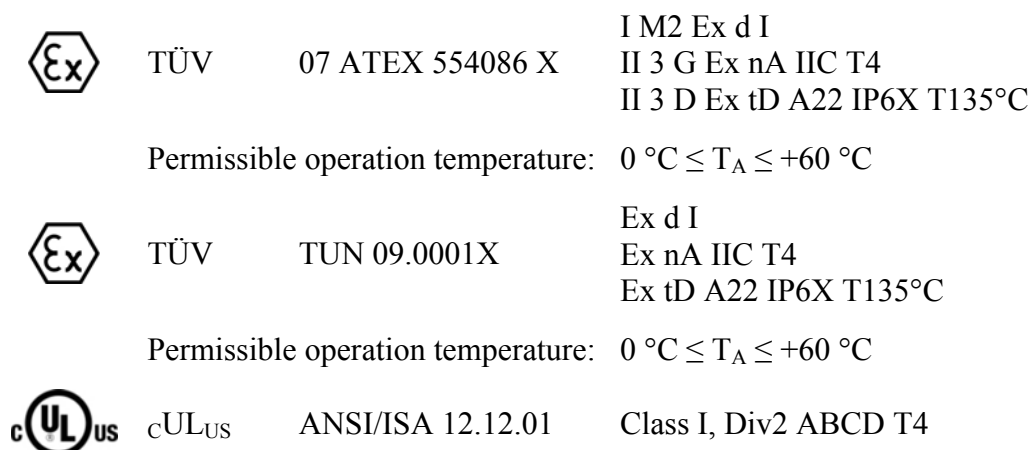

The following Ex approvals have been granted to the variation 750-502/000-800:

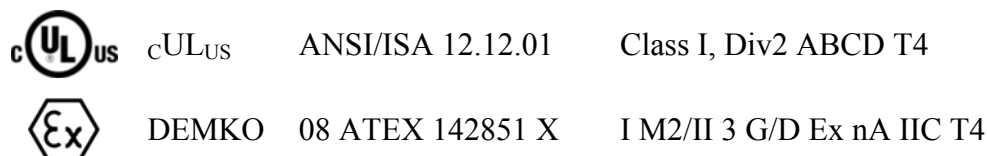

The following ship approvals have been granted to the basic version of 750-502 I/O modules:



ABS (American Bureau of Shipping)



Federal Maritime and Hydrographic Agency



BV (Bureau Veritas)



DNV (Det Norske Veritas) Class B



GL (Germanischer Lloyd) Cat. A, B, C, D (EMC 1)



KR (Korean Register of Shipping)



LR (Lloyd's Register) Env. 1, 2, 3, 4



NKK (Nippon Kaiji Kyokai)



PRS (Polski Rejestr Statków)



RINA (Registro Italiano Navale)

### 3.8 Standards and Guidelines

750-502 I/O modules meet the following requirements on emission and immunity of interference:

EMC CE-Immunity to interference	acc. to EN 61000-6-4: 2007
EMC CE-Immunity to interference	acc. to EN 61000-6-2: 2005
EMC marine applications-Emission of interference	acc. to Germanischer Lloyd (2003)
EMC marine applications-Immunity to interference	acc. to Germanischer Lloyd (2003)



## 4 Assembly

### 4.1 Assembly Sequence

All system components can be snapped directly on a carrier rail in accordance with the European standard EN 50022 (DIN 35).

The reliable positioning and connection is made using a tongue and groove system. Due to the automatic locking, the individual components are securely seated on the rail after installation.

Starting with the coupler/controller, the bus modules are assembled adjacent to each other according to the project design. Errors in the design of the node in terms of the potential groups (connection via the power contacts) are recognized, as the bus modules with power contacts (male contacts) cannot be linked to bus modules with fewer power contacts.

---

#### CAUTION

##### **Risk of injury due to sharp-edged male contacts!**

The male contacts are sharp-edged. Handle the module carefully to prevent injury.

---

#### NOTICE

##### **Connect the I/O modules in the required order!**

Never plug bus modules from the direction of the end terminal. A ground wire power contact, which is inserted into a terminal without contacts, e.g. a 4-channel digital input module, has a decreased air and creepage distance to the neighboring contact in the example DI4.

---

#### NOTICE

##### **Assemble the I/O modules in rows only if the grooves are open!**

Please take into consideration that some bus modules have no or only a few power jumper contacts. The design of some modules does not allow them to be physically assembled in rows, as the grooves for the male contacts are closed at the top.

---

#### Note



##### **Don't forget the bus end module!**

Always plug a bus end module 750-600 onto the end of the fieldbus node! You must always use a bus end module at all fieldbus nodes with the WAGO I/O System 750 fieldbus couplers/controllers to guarantee proper data transfer.

---

## 4.2 Inserting and Removing Devices

### DANGER

#### **Use caution when interrupting the PE!**

Make sure that people or equipment are not placed at risk when removing an I/O module and the associated PE interruption. To prevent interruptions, provide ring feeding of the ground conductor, see section "Grounding/Ground Conductor" in manual "System Description WAGO-I/O-SYSTEM 750".

### NOTICE

#### **Perform work on devices only if the system is de-energized!**

Working on devices when the system is energized can damage the devices. Therefore, turn off the power supply before working on the devices.

### 4.2.1 Inserting I/O Module

1. Position the I/O module so that the tongue and groove joints to the fieldbus coupler/controller or to the previous or possibly subsequent I/O module are engaged.

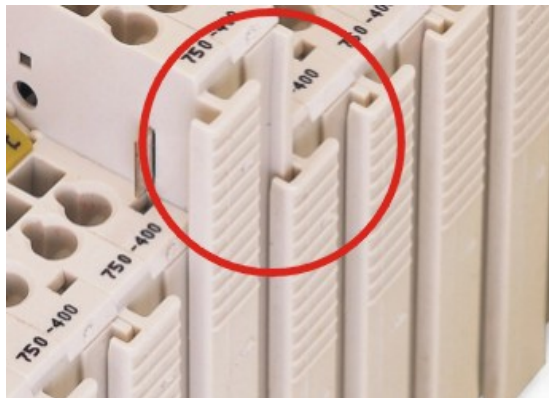

Figure 7: Insert I/O module

2. Press the I/O module into the assembly until the I/O module snaps into the carrier rail.

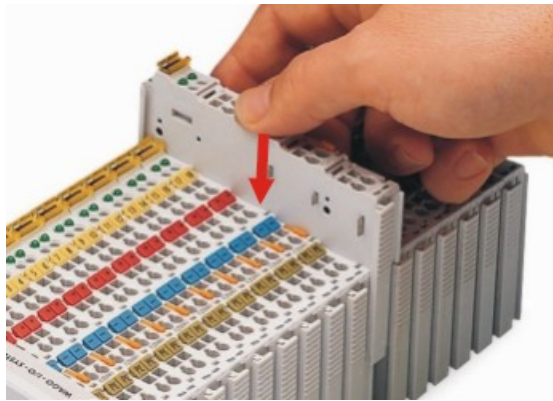

Figure 8: Snap the I/O module into place

With the I/O module snapped in place, the electrical connections for the data contacts and power contacts (if any) to the fieldbus coupler/controller or to the previous or possibly subsequent I/O module are established.

## 4.2.2 Removing the I/O Module

1. Remove the I/O module from the assembly by pulling the release tab.

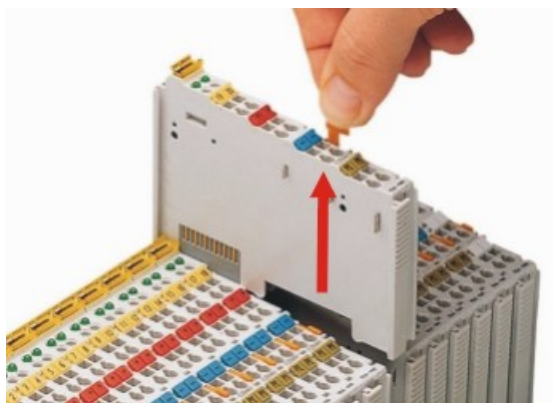

Figure 9: Removing the I/O module

Electrical connections for data or power contacts are disconnected when removing the I/O module.

## 5 Connect Devices

### 5.1 Connecting a conductor to the CAGE CLAMP®

The WAGO CAGE CLAMP® connection is appropriate for solid, stranded and finely stranded conductors.

#### Note



**Only connect one conductor to each CAGE CLAMP® connection!**

Only one conductor may be connected to each CAGE CLAMP® connection.

Do not connect more than one conductor at one single connection!

If more than one conductor must be routed to one connection, these must be connected in an up-circuit wiring assembly, for example using WAGO feed-through terminals.

#### Exception:

If it is unavoidable to jointly connect 2 conductors, then you must use a ferrule to join the wires together. The following ferrules can be used:

Length	8 mm
Nominal cross section <sub>max.</sub>	1 mm <sup>2</sup> for 2 conductors with 0.5 mm <sup>2</sup> each
WAGO Product	216-103 or products with comparable properties.

1. To open the CAGE CLAMP® insert the actuating tool into the opening above the connection.
2. Insert the conductor into the corresponding connection opening.
3. To close the CAGE CLAMP® simply remove the tool - the conductor is then clamped firmly in place.

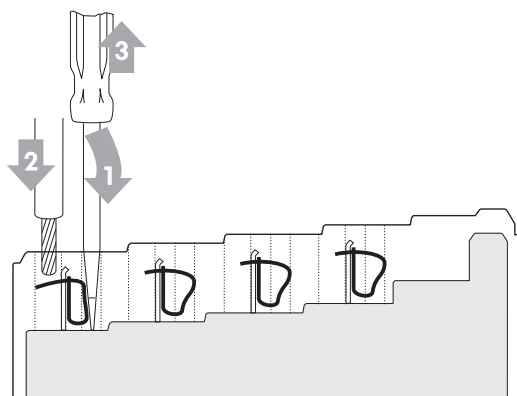

Figure 10: Connecting a conductor to a CAGE CLAMP®

## 5.2 Connection Examples

### 5.2.1 2-Conductor Connection, ungrounded

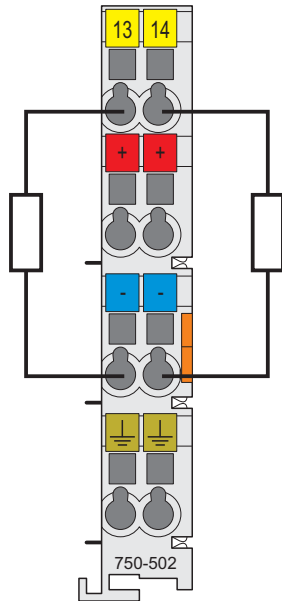

Figure 11: Connecting diagram 2-conductor connection, ungrounded

### 5.2.2 2-Conductor Connection, grounded

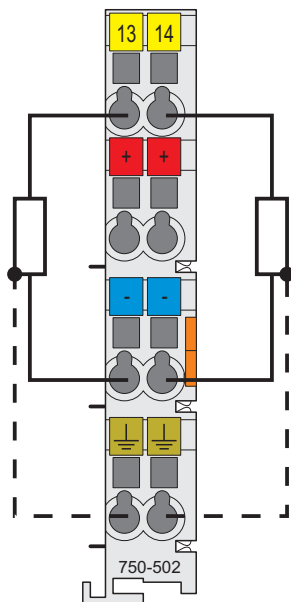

Figure 12: Connecting diagram 2-conductor connection, grounded

### 5.2.3 3-Conductor Connection, ungrounded

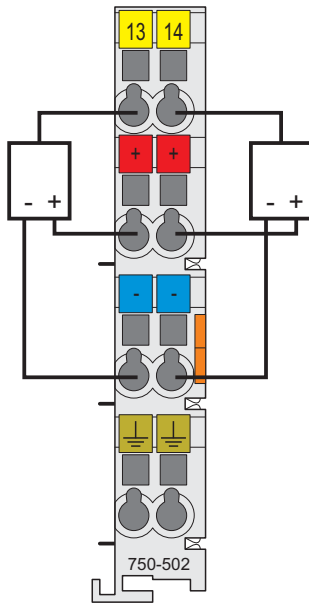

Figure 13: Connecting diagram 3-conductor connection, ungrounded

### 5.2.4 3-Conductor Connection, grounded

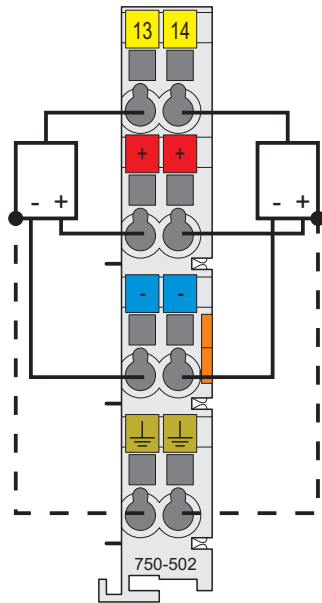

Figure 14: Connecting diagram 3-conductor connection, grounded

## 6 Process Image

### Note



#### Mapping of process data in the process image of fieldbus systems

The representation of the process data of some I/O modules or their variations in the process image depends on the fieldbus coupler/controller used. Please take this information from the section "Fieldbus Specific Design of the Process Data" included in the description concerning the process image of the corresponding coupler/controller.

Table 12: Outputbyte D0

Bit 7	Bit 6	Bit 5	Bit 4	Bit 3	Bit 2	Bit 1	Bit 0
0	0	0	0	0	0	DO 2	DO 1
DO 1		Signal state DO 1 – Digital Output Channel 1					
DO 2		Signal state DO 2 – Digital Output Channel 2					
0		Reserved					

## 7 Using Interference-Free Variations of I/O Modules in Safety Related Applications

The variation 750-502/xxx-8xx of the I/O module 750-502 (designation "... /R" in the product name) is suited for use in interference-free safety circuits.

If the field side supply is shut down via a safety switching device, the safety function of the module is not active.

When the interference-free IO module is used correctly in a safety related application, neither the SIL or Performance Level achieved by the circuit nor the Category will be influenced.

This requires that you adhere to the following notes and connection diagrams!



## 7.1 Important Notes

### NOTICE

#### **Damage to Property!**

Only a power supply unit with protective extra-low voltage (PELV) shall be used for the 24 V power supply.

### NOTICE

#### **Damage to Property!**

IP54 protection class is absolutely mandatory. This means that the interference-free digital output module shall only be integrated and operated in switch boxes or switch cabinets complying with IP54 or higher.

### NOTICE

#### **Damage to Property!**

The 24 V power supply shall never be applied to the output of an interference-free digital output module. This wiring failure will not be detected by the system.

### NOTICE

#### **Damage to Property!**

A group of interference-free digital output modules shall only be supplied using a safety switching device. Reverse supply must absolutely be avoided.

### NOTICE

#### **Damage to Property!**

Short circuits between outputs of different interference-free digital output modules must absolutely be avoided as they are not detected by the system.

According to EN ISO 13849-2, the following measures are required for an "external voltage" fault exclusion:

- Use of cables routed separately and
- Protection from external damage (e.g., caused by cable duct).

## 7.2 Connecting the IO Module to Safety Switching Devices or Safety Modules

### 7.2.1 General Structure

When using the interference-free variation ".../8xx-xxx" of the IO module 750-502 in safety related applications, the modules belonging to a safety switching device shall be combined to form a potential group. Power to the potential group shall be supplied via a power supply module 750-601 or 750-602 or via filter module 750-626. Either a power supply module or a separation module without power jumper contacts (750-616) must be connected at the end of the potential group.

Safety switch module/  
Safety module

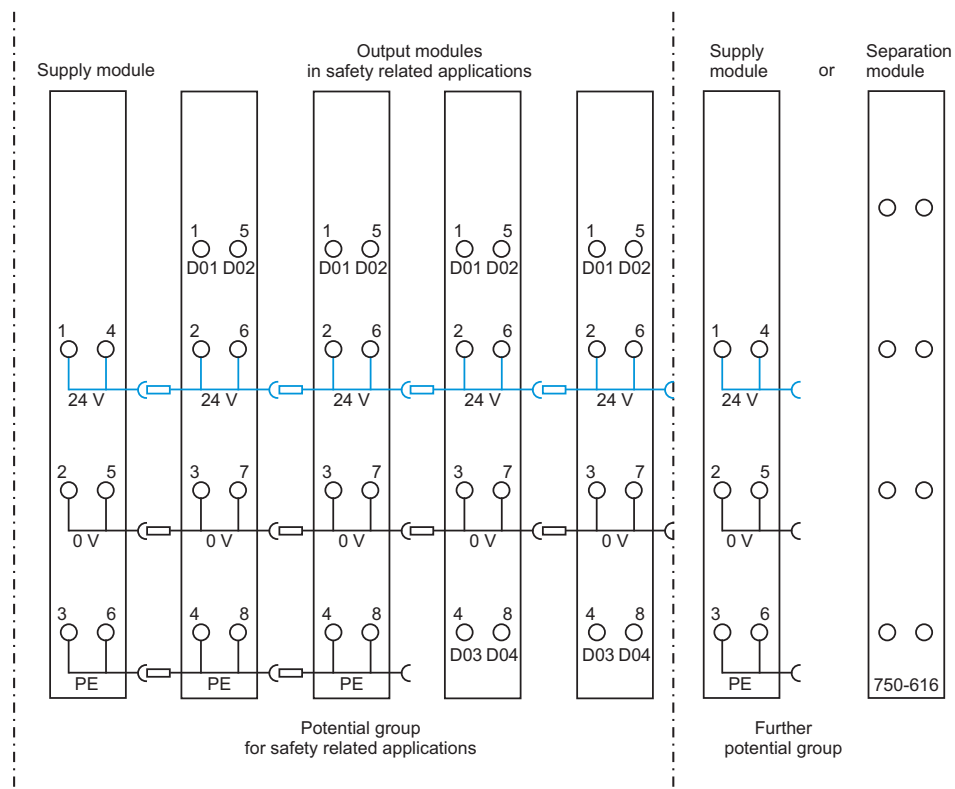

Figure 15: Potential group for safety related applications

## 7.2.2 Examples of Connection

### Two-Channel Single-Pole Power Supply Disconnection

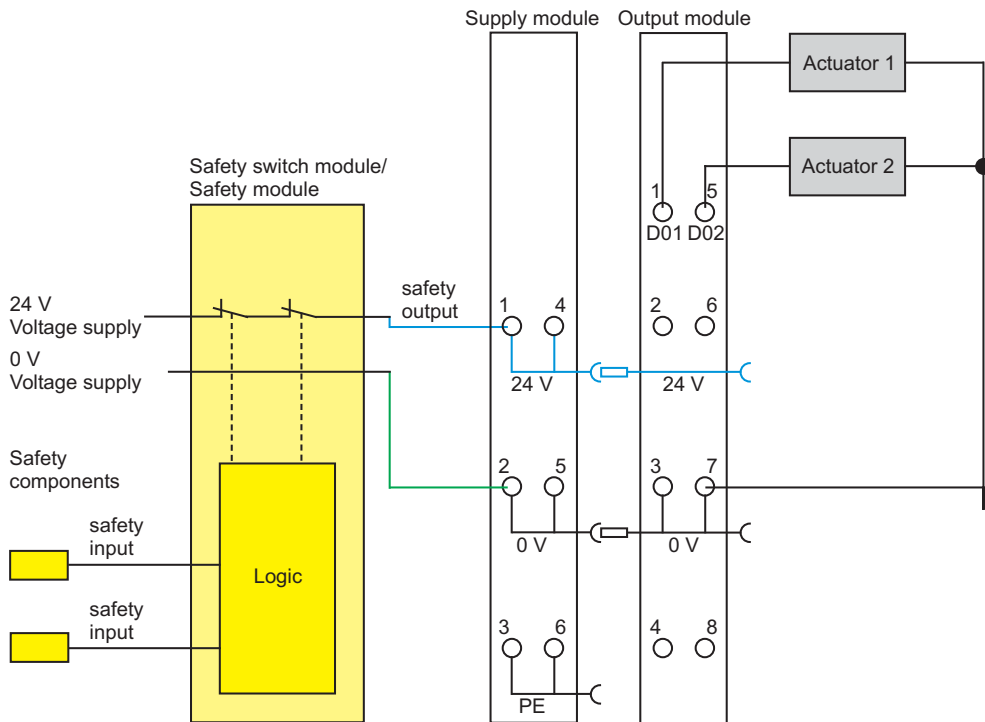

Figure 16: Two-channel single-pole disconnection

### Two-Channel Double-Pole Power Supply Disconnection

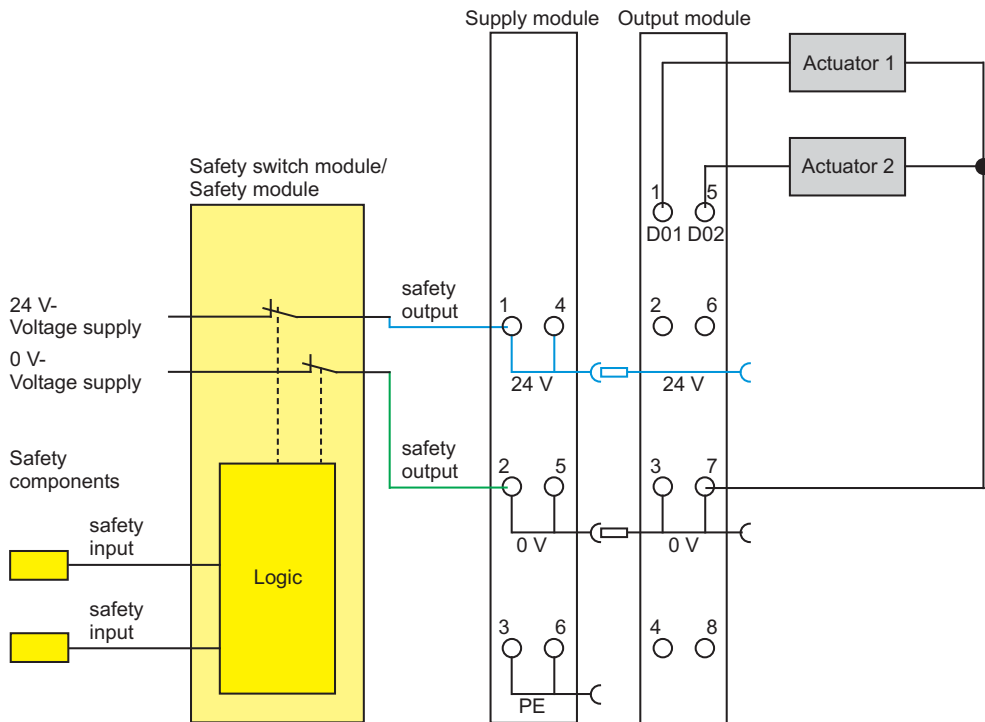

Figure 17: Two-channel double-pole disconnection



## 8 Use in Hazardous Environments

The **WAGO-I/O-SYSTEM 750** (electrical equipment) is designed for use in Zone 2 hazardous areas.

The following sections include both the general identification of components (devices) and the installation regulations to be observed. The individual subsections of the "Installation Regulations" section must be taken into account if the I/O module has the required approval or is subject to the range of application of the ATEX directive.

## 8.1 Identification

### 8.1.1 For Europe according to CENELEC and IEC

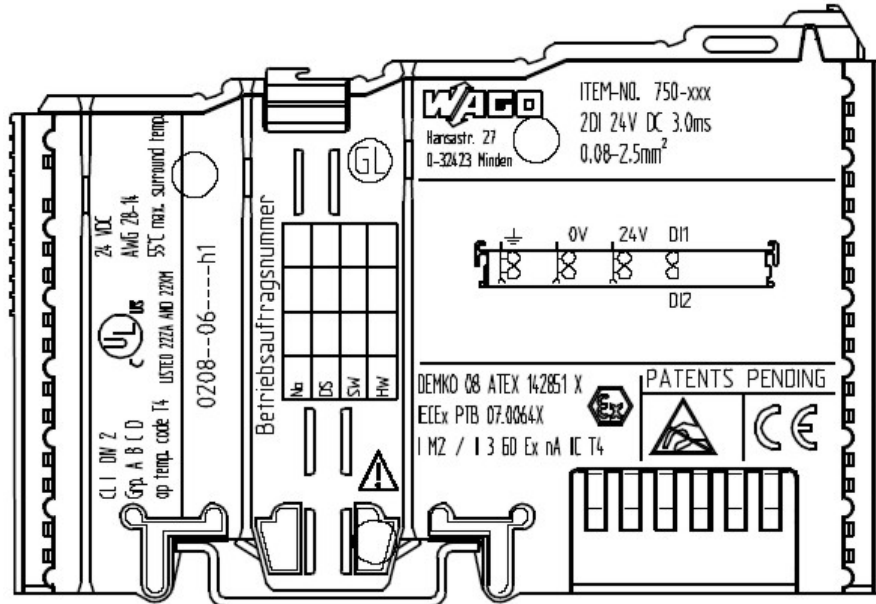

Figure 18: Example for lateral labeling of bus modules

DEMKO 08 ATEX 142851 X  
 IECEX PTB 07.0064X   
 I M2 / II 3 GD Ex nA IIC T4

Figure 19: Printing on text detail in accordance with CENELEC and IEC

Table 13: Description of Printing on

Printing on Text	Description
DEMKO 08 ATEX 142851 X IECEX PTB 07.0064X	Approval body and/or number of the examination certificate
I M2 / II 3 GD	Explosion protection group and Unit category
Ex nA	Type of ignition and extended identification
IIC	Explosion protection group
T4	Temperature class

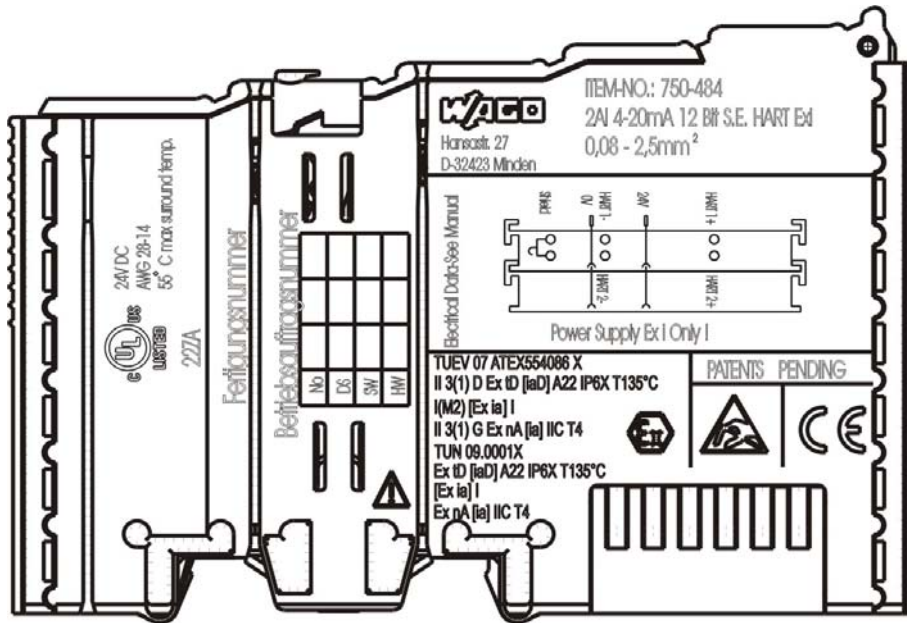

Figure 20: Example of side marking of Ex i and IEC Ex i approved I/O modules

**TUEV 07 ATEX554086 X**  
**II 3(1) D Ex tD [IaD] A22 IP6X T135°C**  
**I(M2) [Ex ia] I**  
**II 3(1) G Ex nA [Ia] IIC T4**  
**TUN 09.0001X**  
**Ex tD [IaD] A22 IP6X T135°C**  
**[Ex ia] I**  
**Ex nA [Ia] IIC T4**



Figure 21: Inscription text detail acc. CENELEC and IEC

Table 14: Description of the inscription

Inscription text	Description
TÜV 07 ATEX 554086 X TUN 09.0001X	Approving authority or certificate numbers
<b>Dust</b>	
II	Device group: All except mining
3(1)D	Device category: Zone 22 device (Zone 20 subunit)
Ex	Explosion protection mark
tD	Protection by enclosure
[iaD]	Approved in accordance with "Dust intrinsic safety" standard
A22	Surface temperature determined according to Procedure A, use in Zone 22
IP6X	Dust-tight (totally protected against dust)
T 135°C	Max. surface temp. of the enclosure (no dust bin)
<b>Mining</b>	
I	Device group: Mining
(M2)	Device category: High degree of safety
[Ex ia]	Explosion protection: Mark with category of type of protection intrinsic safety: Even safe when two errors occur
I	Device group: Mining
<b>Gases</b>	
II	Device group: All except mining
3(1)G	Device category: Zone 2 device (Zone 0 subunit)
Ex	Explosion protection mark
nA	Type of protection: Non-sparking operating equipment
[ia]	Category of type of protection intrinsic safety: Even safe when two errors occur
IIC	Explosion Group
T4	Temperature class: Max. surface temperature 135°C



### 8.1.2 For America according to NEC 500

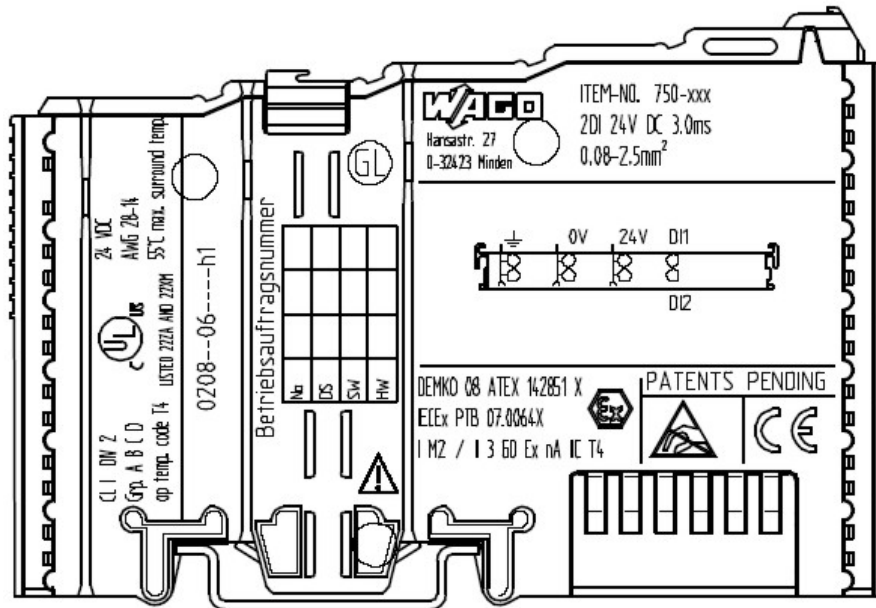

Figure 22: Example for lateral labeling of bus modules



Figure 23: Printing on text detail in accordance with NEC

Table 15: Description of Printing on

Printing on Text	Description
CL 1	Explosion protection group (condition of use category)
DIV 2	Area of application (zone)
Grp. ABCD	Explosion group (gas group)
Optemp code T4	Temperature class

## 8.2 Installation Regulations

In the **Federal Republic of Germany**, various national regulations for the installation in explosive areas must be taken into consideration. The basis for this forms the working reliability regulation, which is the national conversion of the European guideline 99/92/E6. They are complemented by the installation regulation EN 60079-14. The following are excerpts from additional VDE regulations:

Table 16: VDE Installation Regulations in Germany

DIN VDE 0100	Installation in power plants with rated voltages up to 1000 V
DIN VDE 0101	Installation in power plants with rated voltages above 1 kV
DIN VDE 0800	Installation and operation in telecommunication plants including information processing equipment
DIN VDE 0185	lightning protection systems

The **USA** and **Canada** have their own regulations. The following are excerpts from these regulations:

Table 17: Installation Regulations in USA and Canada

NFPA 70	National Electrical Code Art. 500 Hazardous Locations
ANSI/ISA-RP 12.6-1987	Recommended Practice
C22.1	Canadian Electrical Code

### NOTICE

#### Notice the following points

When using the **WAGO-I/O SYSTEM 750** (electrical operation) with Ex approval, the following points are mandatory:

## 8.2.1 Special Conditions for Safe Operation of the ATEX and IEC Ex (acc. DEMKO 08 ATEX 142851X and IECEx PTB 07.0064)

The fieldbus-independent I/O modules of the WAGO-I/O-SYSTEMs 750-.../...-... Must be installed in an environment with degree of pollution 2 or better. In the final application, the I/O modules must be mounted in an enclosure with IP 54 degree of protection at a minimum with the following exceptions:

- I/O modules 750-440, 750-609 and 750-611 must be installed in an IP 64 minimum enclosure.
- I/O module 750-540 must be installed in an IP 64 minimum enclosure for 230 V AC applications.
- I/O module 750-440 may be used up to max. 120 V AC.

When used in the presence of combustible dust, all devices and the enclosure shall be fully tested and assessed in compliance with the requirements of IEC 61241-0:2004 and IEC 61241-1:2004.

I/O modules fieldbus plugs or fuses may only be installed, added, removed or replaced when the system and field supply is switched off or the area exhibits no explosive atmosphere.

DIP switches, coding switches and potentiometers that are connected to the I/O module may only be operated if an explosive atmosphere can be ruled out.

I/O module 750-642 may only be used in conjunction with antenna 758-910 with a max. cable length of 2.5 m.

To exceed the rated voltage no more than 40%, the supply connections must have transient protection.

The permissible ambient temperature range is 0 °C to +55 °C.

## 8.2.2 Special conditions for safe use (ATEX Certificate TÜV 07 ATEX 554086 X)

1. For use as Gc- or Dc-apparatus (in zone 2 or 22) the fieldbus independent I/O modules WAGO-I/O-SYSTEM 750-\*\*\* shall be erected in an enclosure that fulfils the requirements of the applicable standards (see the marking) EN 60079-0, EN 60079-11, EN 60079-15, EN 61241-0 and EN 61241-1. For use as group I, electrical apparatus M2, the apparatus shall be erected in an enclosure that ensures a sufficient protection according to EN 60079-0 and EN 60079-1 and the degree of protection IP64. The compliance of these requirements and the correct installation into an enclosure or a control cabinet of the devices shall be certified by an ExNB.
2. If the interface circuits are operated without the fieldbus coupler station type 750-3./...-... (DEMKO 08 ATEX 142851 X) measures must be taken outside of the device so that the rating voltage is not being exceeded of more than 40% because of transient disturbances.
3. DIP-switches, binary-switches and potentiometers, connected to the module may only be actuated when explosive atmosphere can be excluded.
4. The connecting and disconnecting of the non-intrinsically safe circuits is only permitted during installation, for maintenance or for repair purposes. The temporal coincidence of explosion hazardous atmosphere and installation, maintenance resp. repair purposes shall be excluded.
5. For the types 750-606, 750-625/000-001, 750-487/003-000, 750-484 the following shall be considered: The interface circuits shall be limited to overvoltage category I/II/III (non mains/mains circuits) as defined in IEC 60664-1.
6. For the type 750-601 the following shall be considered: Do not remove or replace the fuse when the apparatus is energized.
7. The ambient temperature range is:  $0^{\circ}\text{C} \leq T_a \leq +55^{\circ}\text{C}$  (for extended details please note certificate).

### 8.2.3 Special conditions for safe use (IEC-Ex Certificate TUN 09.0001 X)

1. For use as Dc- or Gc-apparatus (in zone 2 or 22) the fieldbus independent I/O modules WAGO-I/O-SYSTEM 750-\*\*\* shall be erected in an enclosure that fulfils the requirements of the applicable standards (see the marking) IEC 60079-0, IEC 60079-11, IEC 60079-15, IEC 61241-0 and IEC 61241-1. For use as group I, electrical apparatus M2, the apparatus shall be erected in an enclosure that ensures a sufficient protection according to IEC 60079-0 and IEC 60079-1 and the degree of protection IP64. The compliance of these requirements and the correct installation into an enclosure or a control cabinet of the devices shall be certified by an ExCB.
2. Measures have to be taken outside of the device that the rating voltage is not being exceeded of more than 40% because of transient disturbances.
3. DIP-switches, binary-switches and potentiometers, connected to the module may only be actuated when explosive atmosphere can be excluded.
4. The connecting and disconnecting of the non-intrinsically safe circuits is only permitted during installation, for maintenance or for repair purposes. The temporal coincidence of explosion hazardous atmosphere and installation, maintenance resp. repair purposes shall be excluded.
5. For the types 750-606, 750-625/000-001, 750-487/003-000, 750-484 the following shall be considered: The interface circuits shall be limited to overvoltage category I/II/III (non mains/mains circuits) as defined in IEC 60664-1.
6. For the type 750-601 the following shall be considered: Do not remove or replace the fuse when the apparatus is energized.
7. The ambient temperature range is:  $0^{\circ}\text{C} \leq T_a \leq +55^{\circ}\text{C}$  (for extended details please note certificate).

## 8.2.4 ANSI/ISA 12.12.01

This equipment is suitable for use in Class I, Division 2, Groups A, B, C, D or non-hazardous locations only.

---

### NOTICE

#### **Explosion hazard!**

Explosion hazard - substitution of components may impair suitability for Class I, Div. 2.

---

---

### NOTICE

#### **Disconnect device when power is off and only in a non-hazardous area!**

Do not disconnect equipment unless power has been switched off or the area is known to be non-hazardous.

---

When a fuse is provided, the following marking shall be provided:

”A switch suitable for the location where the equipment is installed shall be provided to remove the power from the fuse”.

The switch need not be integrated in the equipment.

For devices with Ethernet connectors:

”Only for use in LAN, not for connection to telecommunication circuits”.

---

### NOTICE

#### **Use only with antenna module 758-910!**

Use Module 750-642 only with antenna module 758-910.

---



---

## Information

#### **Additional Information**

Proof of certification is available on request. Also take note of the information given on the module technical information sheet. The Instruction Manual, containing these special conditions for safe use, must be readily available to the user.

---

## List of Figures

Figure 1: View .....	16
Figure 2: Data contacts .....	17
Figure 3: Power jumper contacts .....	18
Figure 4: Connections .....	19
Figure 5: Display elements .....	20
Figure 6: Schematic diagram .....	21
Figure 7: Insert I/O module .....	26
Figure 8: Snap the I/O module into place .....	27
Figure 9: Removing the I/O module .....	27
Figure 10: Connecting a conductor to a CAGE CLAMP® .....	28
Figure 11: Connecting diagram 2-conductor connection, ungrounded .....	29
Figure 12: Connecting diagram 2-conductor connection, grounded .....	29
Figure 13: Connecting diagram 3-conductor connection, ungrounded .....	30
Figure 14: Connecting diagram 3-conductor connection, grounded .....	30
Figure 15: Potential group for safety related applications .....	34
Figure 16: Two-channel single-pole disconnection .....	35
Figure 17: Two-channel double-pole disconnection .....	35
Figure 18: Example for lateral labeling of bus modules .....	38
Figure 19: Printing on text detail in accordance with CENELEC and IEC .....	38
Figure 20: Example of side marking of Ex i and IEC Ex i approved I/O modules .....	39
Figure 21: Inscription text detail acc. CENELEC and IEC .....	39
Figure 22: Example for lateral labeling of bus modules .....	41
Figure 23: Printing on text detail in accordance with NEC .....	41

---

## List of Tables

Table 1: Variants .....	5
Table 2: Number Notation.....	9
Table 3: Font Conventions .....	9
Table 4: Caption acc. to figure „Connections“.....	16
Table 5: Power jumper contacts .....	18
Table 6: Connections.....	19
Table 7: Display elements .....	20
Table 8: Technical data device.....	22
Table 9: Technical data power supply.....	22
Table 10: Technical data communication .....	22
Table 11: Technical data outputs.....	22
Table 12: Outputbyte D0.....	31
Table 13: Description of Printing on.....	38
Table 14: Description of the inscription.....	40
Table 15: Description of Printing on.....	41
Table 16: VDE Installation Regulations in Germany .....	42
Table 17: Installation Regulations in USA and Canada.....	42





WAGO Kontakttechnik GmbH & Co. KG  
Postfach 2880 • D-32385 Minden  
Hansastraße 27 • D-32423 Minden  
Phone: +49/5 71/8 87 – 0  
Fax: +49/5 71/8 87 – 1 69  
E-Mail: info@wago.com  
Internet: <http://www.wago.com>

