

WAGO-I/O-SYSTEM 750

8DI 24V DC 3,0ms

753-430

8-Channel Digital Input Module 24 VDC;
1-Conductor Connection; High-side Switching

Version 1.2.0

WAGO®

© 2014 by WAGO Kontakttechnik GmbH & Co. KG
All rights reserved.

WAGO Kontakttechnik GmbH & Co. KG

Hansastraße 27
D-32423 Minden

Phone: +49 (0) 571/8 87 – 0
Fax: +49 (0) 571/8 87 – 1 69

E-Mail: info@wago.com

Web: <http://www.wago.com>

Technical Support

Phone: +49 (0) 571/8 87 – 5 55
Fax: +49 (0) 571/8 87 – 85 55

E-Mail: support@wago.com

Every conceivable measure has been taken to ensure the accuracy and completeness of this documentation. However, as errors can never be fully excluded, we always appreciate any information or suggestions for improving the documentation.

E-Mail: documentation@wago.com

We wish to point out that the software and hardware terms as well as the trademarks of companies used and/or mentioned in the present manual are generally protected by trademark or patent.

Table of Contents

1	Notes about this Documentation	5
1.1	Validity of this Documentation	5
1.2	Copyright	5
1.3	Symbols	6
1.4	Number Notation	8
1.5	Font Conventions	8
2	Important Notes	9
2.1	Legal Bases	9
2.1.1	Subject to Changes	9
2.1.2	Personnel Qualifications	9
2.1.3	Use of the WAGO-I/O-SYSTEM 750 in Compliance with Underlying Provisions	9
2.1.4	Technical Condition of Specified Devices	10
2.2	Safety Advice (Precautions)	11
3	Device Description	13
3.1	View	15
3.2	Connectors	16
3.2.1	Data Contacts/Internal Bus	16
3.2.2	Power Jumper Contacts/Field Supply	17
3.2.3	CAGE CLAMP® Connectors	19
3.3	Display Elements	20
3.4	Operating Elements	20
3.5	Schematic Diagram	21
3.6	Technical Data	22
3.6.1	Device	22
3.6.2	Supply	22
3.6.3	Communication	22
3.6.4	Inputs	22
3.6.5	Connection	22
3.6.6	Climatic Environmental Conditions	23
3.7	Approvals	24
3.8	Standards and Guidelines	26
4	Process Image	27
5	Mounting	28
5.1	Mounting Sequence	28
5.2	Inserting and Removing Devices	29
5.2.1	Inserting the I/O Module	29
5.2.2	Removing the I/O Module	30
5.3	I/O Modules with Pluggable Wiring Level (Series 753)	31
5.3.1	Coding	32
5.3.2	Connector Removal	34
6	Connect Devices	35
6.1	Connecting a Conductor to the CAGE CLAMP®	35

7	Use in Hazardous Environments	36
7.1	Marking Configuration Examples.....	37
7.1.1	Marking for Europe According to ATEX and IEC-Ex	37
7.1.2	Marking for America According to NEC 500.....	42
7.2	Installation Regulations.....	43
7.2.1	Special Conditions for Safe Use (ATEX Certificate TÜV 07 ATEX 554086 X)	44
7.2.2	Special Conditions for Safe Use (ATEX Certificate TÜV 12 ATEX 106032 X)	45
7.2.3	Special Conditions for Safe Use (IEC-Ex Certificate TUN 09.0001 X).....	46
7.2.4	Special Conditions for Safe Use (IEC-Ex Certificate IECEX TUN 12.0039 X).....	47
7.2.5	Special Conditions for Safe Use according to ANSI/ISA 12.12.01 ...	48
	List of Figures	49
	List of Tables.....	50

1 Notes about this Documentation

Note



Always retain this documentation!

This documentation is part of the product. Therefore, retain the documentation during the entire service life of the product. Pass on the documentation to any subsequent user. In addition, ensure that any supplement to this documentation is included, if necessary.

1.1 Validity of this Documentation

This documentation is only applicable to the I/O module 753-430 (8DI 24V DC 3,0ms).

The I/O module 753-430 shall only be installed and operated according to the instructions in this manual and in the manual for the used fieldbus coupler/controller.

NOTICE

Consider power layout of the WAGO-I/O-SYSTEM 750!

In addition to these operating instructions, you will also need the manual for the used fieldbus coupler/controller, which can be downloaded at www.wago.com. There, you can obtain important information including information on electrical isolation, system power and supply specifications.

1.2 Copyright

This Manual, including all figures and illustrations, is copyright-protected. Any further use of this Manual by third parties that violate pertinent copyright provisions is prohibited. Reproduction, translation, electronic and phototechnical filing/archiving (e.g., photocopying) as well as any amendments require the written consent of WAGO Kontakttechnik GmbH & Co. KG, Minden, Germany. Non-observance will involve the right to assert damage claims.

1.3 Symbols

DANGER

Personal Injury!

Indicates a high-risk, imminently hazardous situation which, if not avoided, will result in death or serious injury.

DANGER



Personal Injury Caused by Electric Current!

Indicates a high-risk, imminently hazardous situation which, if not avoided, will result in death or serious injury.

WARNING

Personal Injury!

Indicates a moderate-risk, potentially hazardous situation which, if not avoided, could result in death or serious injury.

CAUTION

Personal Injury!

Indicates a low-risk, potentially hazardous situation which, if not avoided, may result in minor or moderate injury.

NOTICE

Damage to Property!

Indicates a potentially hazardous situation which, if not avoided, may result in damage to property.

NOTICE



Damage to Property Caused by Electrostatic Discharge (ESD)!

Indicates a potentially hazardous situation which, if not avoided, may result in damage to property.

Note



Important Note!

Indicates a potential malfunction which, if not avoided, however, will not result in damage to property.



Information

Additional Information:

Refers to additional information which is not an integral part of this documentation (e.g., the Internet).

1.4 Number Notation

Table 1: Number Notation

Number code	Example	Note
Decimal	100	Normal notation
Hexadecimal	0x64	C notation
Binary	'100' '0110.0100'	In quotation marks, nibble separated with dots (.)

1.5 Font Conventions

Table 2: Font Conventions

Font type	Indicates
<i>italic</i>	Names of paths and data files are marked in italic-type. e.g.: <i>C:\Programme\WAGO-I/O-CHECK</i>
Menu	Menu items are marked in bold letters. e.g.: Save
>	A greater-than sign between two names means the selection of a menu item from a menu. e.g.: File > New
Input	Designation of input or optional fields are marked in bold letters, e.g.: Start of measurement range
“Value”	Input or selective values are marked in inverted commas. e.g.: Enter the value “4 mA” under Start of measurement range .
[Button]	Pushbuttons in dialog boxes are marked with bold letters in square brackets. e.g.: [Input]
[Key]	Keys are marked with bold letters in square brackets. e.g.: [F5]

2 Important Notes

This section includes an overall summary of the most important safety requirements and notes that are mentioned in each individual section. To protect your health and prevent damage to devices as well, it is imperative to read and carefully follow the safety guidelines.

2.1 Legal Bases

2.1.1 Subject to Changes

WAGO Kontakttechnik GmbH & Co. KG reserves the right to provide for any alterations or modifications that serve to increase the efficiency of technical progress. WAGO Kontakttechnik GmbH & Co. KG owns all rights arising from the granting of patents or from the legal protection of utility patents. Third-party products are always mentioned without any reference to patent rights. Thus, the existence of such rights cannot be excluded.

2.1.2 Personnel Qualifications

All sequences implemented on WAGO-I/O-SYSTEM 750 devices may only be carried out by electrical specialists with sufficient knowledge in automation. The specialists must be familiar with the current norms and guidelines for the devices and automated environments.

All changes to the coupler or controller should always be carried out by qualified personnel with sufficient skills in PLC programming.

2.1.3 Use of the WAGO-I/O-SYSTEM 750 in Compliance with Underlying Provisions

Fieldbus couplers, fieldbus controllers and I/O modules found in the modular WAGO-I/O-SYSTEM 750 receive digital and analog signals from sensors and transmit them to actuators or higher-level control systems. Using programmable controllers, the signals can also be (pre-) processed.

The devices have been developed for use in an environment that meets the IP20 protection class criteria. Protection against finger injury and solid impurities up to 12.5 mm diameter is assured; protection against water damage is not ensured. Unless otherwise specified, operation of the devices in wet and dusty environments is prohibited.

Operating the WAGO-I/O-SYSTEM 750 devices in home applications without further measures is only permitted if they meet the emission limits (emissions of interference) according to EN 61000-6-3. You will find the relevant information in the section “Device Description” > “Standards and Guidelines” in the manual for the used fieldbus coupler/controller.

Appropriate housing (per 94/9/EG) is required when operating the WAGO-I/O-SYSTEM 750 in hazardous environments. Please note that a prototype test certificate must be obtained that confirms the correct installation of the system in a housing or switch cabinet.

2.1.4 Technical Condition of Specified Devices

The devices to be supplied ex works are equipped with hardware and software configurations, which meet the individual application requirements. WAGO Kontakttechnik GmbH & Co. KG will be exempted from any liability in case of changes in hardware or software as well as to non-compliant usage of devices.

Please send your request for modified and new hardware or software configurations directly to WAGO Kontakttechnik GmbH & Co. KG.

2.2 Safety Advice (Precautions)

For installing and operating purposes of the relevant device to your system the following safety precautions shall be observed:



DANGER

Do not work on devices while energized!

All power sources to the device shall be switched off prior to performing any installation, repair or maintenance work.

DANGER

Install the device only in appropriate housings, cabinets or in electrical operation rooms!

The WAGO-I/O-SYSTEM 750 and its components are an open system. As such, install the system and its components exclusively in appropriate housings, cabinets or in electrical operation rooms. Allow access to such equipment and fixtures to authorized, qualified staff only by means of specific keys or tools.

NOTICE

Replace defective or damaged devices!

Replace defective or damaged device/module (e.g., in the event of deformed contacts), since the long-term functionality of device/module involved can no longer be ensured.

NOTICE

Protect the components against materials having seeping and insulating properties!

The components are not resistant to materials having seeping and insulating properties such as: aerosols, silicones and triglycerides (found in some hand creams). If you cannot exclude that such materials will appear in the component environment, then install the components in an enclosure being resistant to the above-mentioned materials. Clean tools and materials are imperative for handling devices/modules.

NOTICE

Clean only with permitted materials!

Clean soiled contacts using oil-free compressed air or with ethyl alcohol and leather cloths.

NOTICE**Do not use any contact spray!**

Do not use any contact spray. The spray may impair contact area functionality in connection with contamination.

NOTICE**Do not reverse the polarity of connection lines!**

Avoid reverse polarity of data and power supply lines, as this may damage the devices involved.

NOTICE**Avoid electrostatic discharge!**

The devices are equipped with electronic components that may be destroyed by electrostatic discharge when touched. Please observe the safety precautions against electrostatic discharge per DIN EN 61340-5-1/-3. When handling the devices, please ensure that environmental factors (personnel, work space and packaging) are properly grounded.

3 Device Description

The digital input module 753-430 receives control signals from digital field (e.g. of sensors, transmitters, switches or proximity switches).

The I/O module has 8 input channels, providing a direct connection to 1-wire sensors.

The sensors are connected to the following CAGE CLAMP® connectors:
DI 1 ... DI 8.

Note



Use field side connection modules!

Where required, use the appropriate field side connection modules for power supply to the sensors.

The assignment of the connections is described in the “Connectors” section. Connection examples are shown in section “Connecting Devices” > ... > “Connection Example(s)”.

Each input channel has an RC noise rejection filter with a time constant of 3.0 ms.

The I/O module inputs provide high-side switching. If the 24 V potential for field power is switched to an input connection, the signal status for the corresponding input channel is set to “high”.

A green LED indicates the switched status of each channel.
The meaning of the LEDs is described in the “Display Elements” section.

The I/O module 753-430 (8DI 24V DC 3,0ms) receives the 24 V voltage supply for the field level from an upstream I/O module or from the fieldbus coupler/controller via two blade-formed power jumper contacts. It then provides these potentials to subsequent I/O modules via two spring-formed power jumper contacts.

NOTICE

Do not exceed maximum current via power jumper contacts!

The maximum current to flow through the power jumper contacts is 10 A. Greater currents can damage the contacts.

When configuring your system, ensure that this current is not exceeded. If exceeded, insert an additional supply module.

Note



Use supply modules for ground (earth)!

The I/O module has no power jumper contacts for receiving and transmitting the earth potential. Use a supply module when an earth potential is needed for the subsequent I/O modules.

The field voltage and the system voltage are electrically isolated from each other.

With consideration of the power jumper contacts, the individual modules can be arranged in any combination when configuring the fieldbus node. An arrangement in groups within the group of potentials is not necessary.

The I/O module 753-430 can be used with all fieldbus couplers/controllers of the WAGO-I/O-SYSTEM 750.

3.1 View

Note



Depiction of the I/O module with 753-110 Connector!

Information on this pluggable connection pertains to the 753-110 Connector, which is not included with the I/O module.

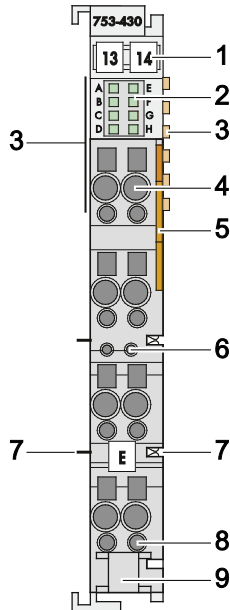

Figure 1: View

Table 3: Legend for Figure “View”

Pos.	Description	Details See Section
1	Marking possibility with Mini-WSB	---
2	Status-LEDs	“Device Description” > “Display Elements”
3	Data contacts	“Device Description” > “Connectors”
4	CAGE CLAMP® connectors	“Device Description” > “Connectors”
5	Release tab	“Mounting” > “Inserting and Removing Devices” and “I/O Modules with Pluggable Wiring Level (Series 753)”
6	Coding possibility with coding fingers	“Mounting” > “Coding”
7	Power jumper contacts	“Device Description” > “Connectors”
8	Test port	---
9	Fixing lug for cable ties	“Mounting” > “I/O Modules with Pluggable Wiring Level (Series 753)”

3.2 Connectors

3.2.1 Data Contacts/Internal Bus

Communication between the fieldbus coupler/controller and the I/O modules as well as the system supply of the I/O modules is carried out via the internal bus. It is comprised of 6 data contacts, which are available as self-cleaning gold spring contacts.

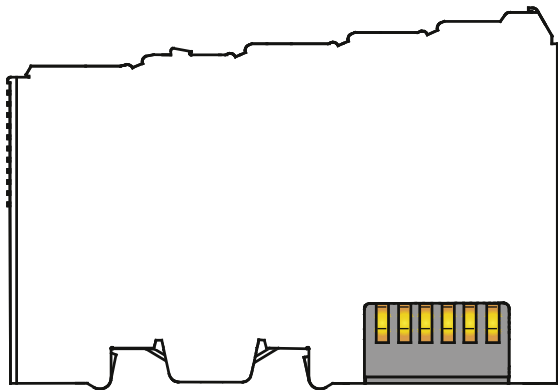

Figure 2: Data Contacts

NOTICE

Do not place the I/O modules on the gold spring contacts!

Do not place the I/O modules on the gold spring contacts in order to avoid soiling or scratching!

NOTICE



Ensure that the environment is well grounded!

The devices are equipped with electronic components that may be destroyed by electrostatic discharge. When handling the devices, ensure that the environment (persons, workplace and packing) is well grounded. Avoid touching conductive components, e.g. data contacts.

3.2.2 Power Jumper Contacts/Field Supply

⚠ CAUTION

Risk of injury due to sharp-edged blade contacts!

The blade contacts are sharp-edged. Handle the I/O module carefully to prevent injury.

The I/O module 753-430 has 2 self-cleaning power jumper contacts that supply and transmit power for the field side. The contacts on the left side of the I/O module are designed as blade contacts and those on the right side as spring contacts.

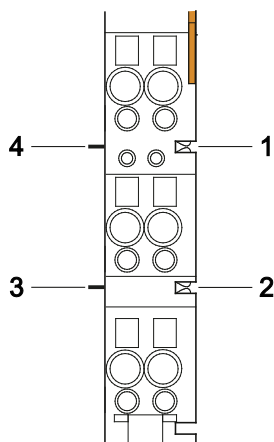

Figure 3: Power Jumper Contacts

Table 4: Legend for Figure “Power Jumper Contacts”

Contact	Type	Function
1	Spring contact	Potential transmission (U_v) for field supply
2	Spring contact	Potential transmission (0 V) for field supply
3	Blade contact	Potential feed-in (0 V) for field supply
4	Blade contact	Potential feed-in (U_v) for field supply

NOTICE

Do not exceed maximum current via power jumper contacts!

The maximum current to flow through the power jumper contacts is 10 A. Greater currents can damage the contacts.

When configuring your system, ensure that this current is not exceeded. If exceeded, insert an additional supply module.

Note



Use supply modules for ground (earth)!

The I/O module has no power jumper contacts for receiving and transmitting the earth potential. Use a supply module when an earth potential is needed for the subsequent I/O modules.

3.2.3 CAGE CLAMP® Connectors

Note



Depiction of the I/O module with 753-110 Connector!

Information on this pluggable connection pertains to the 753-110 Connector, which is not included with the I/O module.

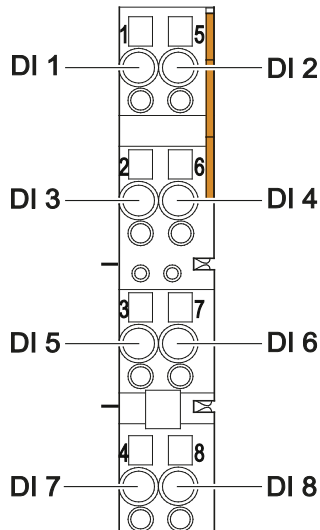

Figure 4: CAGE CLAMP® Connectors

Table 5: Legend for Figure “CAGE CLAMP® Connectors”

Channel	Designation	Connector	Function
1	DI 1	1	Input DI 1: signal voltage
2	DI 2	5	Input DI 2: signal voltage
3	DI 3	2	Input DI 3: signal voltage
4	DI 4	6	Input DI 4: signal voltage
5	DI 5	3	Input DI 5: signal voltage
6	DI 6	7	Input DI 6: signal voltage
7	DI 7	4	Input DI 7: signal voltage
8	DI 8	8	Input DI 8: signal voltage

3.3 Display Elements

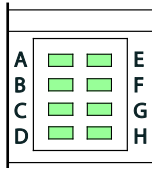

Figure 5: Display Elements

Table 6: Legend for Figure “Display Elements”

Channel	Designation	LED	Status	Function
1	State DI 1	A	Off	Input DI 1: Signal voltage (0)
			Green	Input DI 1: Signal voltage (1)
2	State DI 2	E	Off	Input DI 2: Signal voltage (0)
			Green	Input DI 2: Signal voltage (1)
3	State DI 3	B	Off	Input DI 3: Signal voltage (0)
			Green	Input DI 3: Signal voltage (1)
4	State DI 4	F	Off	Input DI 4: Signal voltage (0)
			Green	Input DI 4: Signal voltage (1)
5	State DI 5	C	Off	Input DI 5: Signal voltage (0)
			Green	Input DI 5: Signal voltage (1)
6	State DI 6	G	Off	Input DI 6: Signal voltage (0)
			Green	Input DI 6: Signal voltage (1)
7	State DI 7	D	Off	Input DI 7: Signal voltage (0)
			Green	Input DI 7: Signal voltage (1)
8	State DI 8	H	Off	Input DI 8: Signal voltage (0)
			Green	Input DI 8: Signal voltage (1)

3.4 Operating Elements

The I/O module 753-430 has no operating elements.

3.5 Schematic Diagram

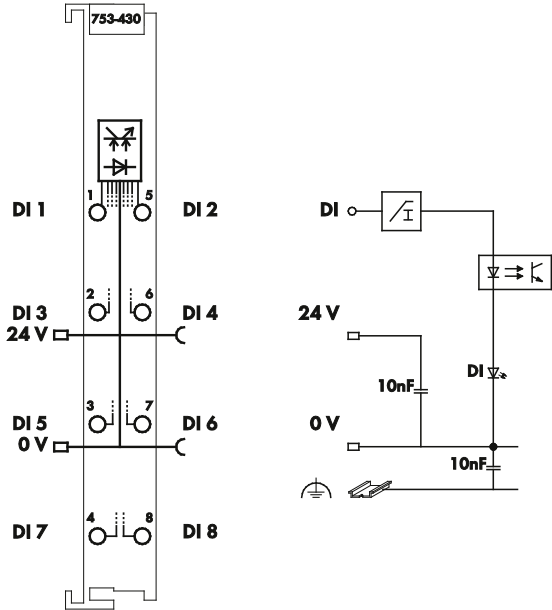

Figure 6: Schematic Diagram

3.6 Technical Data

3.6.1 Device

Table 7: Technical Data – Device

Width	12 mm
Height (from upper edge of 35 DIN rail)	64 mm
Depth	100 mm
Weight	Approx. 49 g

3.6.2 Supply

Table 8: Technical Data – Supply

Current consumption (internal)	17 mA
Voltage via power jumper contacts	24 VDC (-25 % ... +30 %)
Isolation (peak value)	500 V system/field

3.6.3 Communication

Table 9: Technical Data – Communication

Internal bit width (terminal bus)	8 bits in
-----------------------------------	-----------

3.6.4 Inputs

Table 10: Technical Data – Inputs

No. of inputs	8
Signal voltage (0)	-3 V ... +5 VDC
Signal voltage (1)	15 V ... 30 VDC
Input filter	3.0 ms
Input current (typ.)	2.8 mA

3.6.5 Connection

Table 11: Technical Data – Field Wiring

Wire connection	CAGE CLAMP®
Cross section	0,08 mm ² ... 2,5 mm ² / AWG 28 ... 14
Stripped length	9 ... 10 mm / 0.37 in

Table 12: Technical Data – Power Jumper Contacts

Power jumper contacts	Blade/spring contact, self-cleaning
Voltage drop at I_{max} .	< 1 V/64 modules

Table 13: Technical Data – Data Contacts

Data contacts	Slide contact, hard gold plated, self-cleaning
---------------	--

3.6.6 Climatic Environmental Conditions

Table 14: Technical Data – Climatic Environmental Conditions

Operating temperature range	0 °C ... 55 °C
Storage temperature range	-25 °C ... +85 °C
Relative humidity without condensation	Max. 95 %
Resistance to harmful substances	Acc. to IEC 60068-2-42 and IEC 60068-2-43
Maximum pollutant concentration at relative humidity < 75 %	SO ₂ ≤ 25 ppm H ₂ S ≤ 10 ppm
Special conditions	Ensure that additional measures for components are taken, which are used in an environment involving: – dust, caustic vapors or gases – ionizing radiation

3.7 Approvals

The following approvals have been granted to 753-430 I/O modules:



Conformity Marking



cUL_{US} UL508



Korea Certification MSIP-REM-W43-DIM750

The following Ex approvals have been granted to 753-430 I/O modules:



TÜV 07 ATEX 554086 X

I M2 Ex d I Mb
II 3 G Ex nA IIC T4 Gc
II 3 D Ex tc IIIC T135°C Dc

Ambient temperature range: $0\text{ °C} \leq T_a \leq +60\text{ °C}$

IECEX TUN 09.0001 X

Ex d I Mb
Ex nA IIC T4 Gc
Ex tc IIIC T135°C Dc

Ambient temperature range: $0\text{ °C} \leq T_a \leq +60\text{ °C}$



cUL_{US} ANSI/ISA 12.12.01
Class I, Div2 ABCD T4

Information



More information about approvals.

Detailed references to the approvals are listed in the document “Overview Approvals **WAGO-I/O-SYSTEM 750**”, which you can find via the internet under: www.wago.com > SERVICES > DOWNLOADS > Additional documentation and information on automation products > WAGO-I/O-SYSTEM 750 > System Description.

The following ship approvals have been granted to the basic version of 753-430 I/O modules:



ABS (American Bureau of Shipping)



BV (Bureau Veritas)



DNV (Det Norske Veritas) Class B



GL (Germanischer Lloyd) Cat. A, B, C, D (EMC 1)



KR (Korean Register of Shipping)



LR (Lloyd's Register) Env. 1, 2, 3, 4



PRS (Polski Rejestr Statków)



RINA (Registro Italiano Navale)

3.8 Standards and Guidelines

753-430 I/O modules meet the following requirements on emission and immunity of interference:

EMC CE-Emission of interference	acc. to EN 61000-6-4: 2007
EMC CE-Immunity to interference	acc. to EN 61000-6-2: 2005
EMC marine applications-Emission of interference	acc. to Germanischer Lloyd (2003)
EMC marine applications-Immunity to interference	acc. to Germanischer Lloyd (2003)

4 Process Image

Table 15: Input Bits

Bit 7	Bit 6	Bit 5	Bit 4	Bit 3	Bit 2	Bit 1	Bit 0
DI 8	DI 7	DI 6	DI 5	DI 4	DI 3	DI 2	DI 1
DI 1	Signal state DI 1 – Digital input channel 1						
DI 2	Signal state DI 2 – Digital input channel 2						
DI 3	Signal state DI 3 – Digital input channel 3						
DI 4	Signal state DI 4 – Digital input channel 4						
DI 5	Signal state DI 5 – Digital input channel 5						
DI 6	Signal state DI 6 – Digital input channel 6						
DI 7	Signal state DI 7 – Digital input channel 7						
DI 8	Signal state DI 8 – Digital input channel 8						

5 Mounting

5.1 Mounting Sequence

Fieldbus couplers/controllers and I/O modules of the WAGO-I/O-SYSTEM 750 are snapped directly on a carrier rail in accordance with the European standard EN 50022 (DIN 35).

The reliable positioning and connection is made using a tongue and groove system. Due to the automatic locking, the individual devices are securely seated on the rail after installation.

Starting with the fieldbus coupler/controller, the I/O modules are mounted adjacent to each other according to the project design. Errors in the design of the node in terms of the potential groups (connection via the power contacts) are recognized, as the I/O modules with power contacts (blade contacts) cannot be linked to I/O modules with fewer power contacts.

CAUTION

Risk of injury due to sharp-edged blade contacts!

The blade contacts are sharp-edged. Handle the I/O module carefully to prevent injury.

NOTICE

Insert I/O modules only from the proper direction!

All I/O modules feature grooves for power jumper contacts on the right side. For some I/O modules, the grooves are closed on the top. Therefore, I/O modules featuring a power jumper contact on the left side cannot be snapped from the top. This mechanical coding helps to avoid configuration errors, which may destroy the I/O modules. Therefore, insert I/O modules only from the right and from the top.

Note



Don't forget the bus end module!

Always plug a bus end module 750-600 onto the end of the fieldbus node! You must always use a bus end module at all fieldbus nodes with WAGO-I/O-SYSTEM 750 fieldbus couplers/controllers to guarantee proper data transfer.

5.2 Inserting and Removing Devices

NOTICE

Perform work on devices only if they are de-energized!

Working on energized devices can damage them. Therefore, turn off the power supply before working on the devices.

5.2.1 Inserting the I/O Module

1. Position the I/O module so that the tongue and groove joints to the fieldbus coupler/controller or to the previous or possibly subsequent I/O module are engaged.

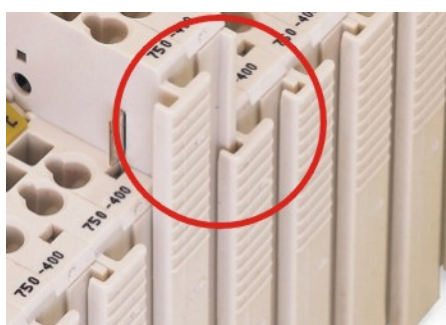

Figure 7: Insert I/O Module (Example)

2. Press the I/O module into the assembly until the I/O module snaps into the carrier rail.

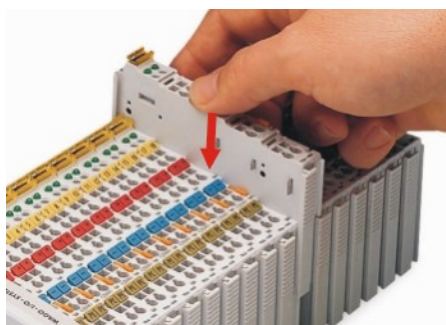

Figure 8: Snap the I/O Module into Place (Example)

With the I/O module snapped in place, the electrical connections for the data contacts and power jumper contacts (if any) to the fieldbus coupler/controller or to the previous or possibly subsequent I/O module are established.

5.2.2 Removing the I/O Module

Note



Remove pluggable connector!

Before removing a 753 Series I/O Module from the node, you must first remove the pluggable connector from the module (see section “Connector Removal”)!

1. Remove the I/O module from the node by pulling the release tab.

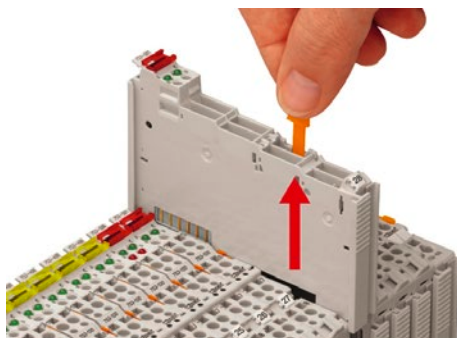

Figure 9: Removing the I/O Module (Example)

Electrical connections for data or power contacts are disconnected when removing the I/O module.

5.3 I/O Modules with Pluggable Wiring Level (Series 753)

Series 753 I/O modules feature a pluggable connector for I/O wiring. This connector is simply plugged into the bottom of the module. The connector can be completely removed together with the wiring, simplifying replacement of defective modules from the assembly.

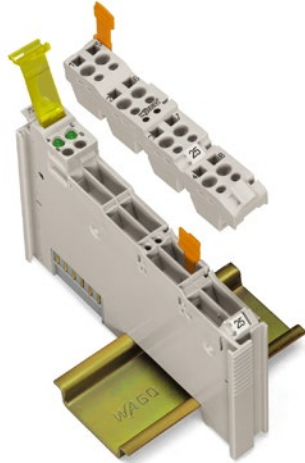

Figure 10: Connector and Module

Miniature WSB marking tags ensure that the right connector is matched up with the right I/O module (see figure below).



Figure 11: Assignment of Module to Connector Using Mini-WSB Tags

This connector provides an option for attaching cable binders.



Figure 12: Attachment of Cable Binders

5.3.1 Coding

Coding using small plastic pins and sockets facilitates mating of the module with the appropriate connector.

1. Insert the pin into the socket.



Figure 13: Assembling the Coding Fingers

2. Position the assembled coding fingers in the I/O module. Due to its design, each coding finger allows four different coding options (i.e.; 16 different options using two coding fingers).

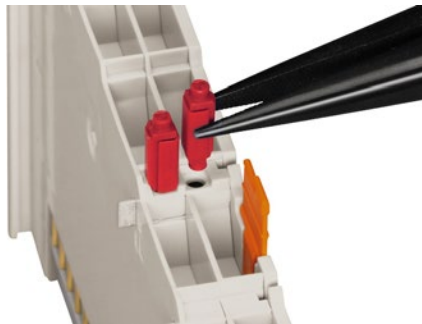

Figure 14: Inserting the Coding Fingers

3. Place the connector onto the I/O module.



Figure 15: Plugging the Connector into Place

4. When the connector is removed the sockets remain in the I/O module. The coded connector can only fit in the corresponding coded I/O module (see figures below).



Figure 16: “Sure Match” Coding Fingers

5.3.2 Connector Removal

1. Remove the connector from the I/O module by pulling the orange pull tab on the connector toward the top of the module.

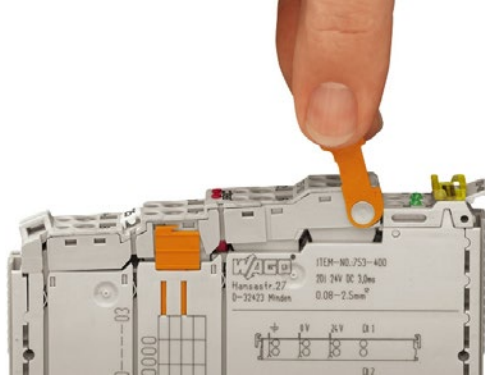

Figure 17: Pulling the Pull Tab

The connector detaches from the module.

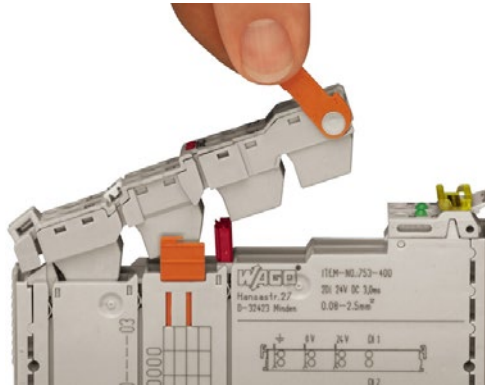

Figure 18: Removing the Connector Without Tools

2. Alternatively, you can also use a standard screwdriver at the position shown (in the figure below) to remove the connector.

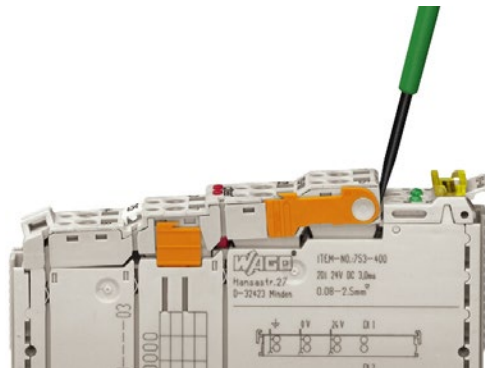

Figure 19: Removing the Connector Using a Screwdriver

6 Connect Devices

6.1 Connecting a Conductor to the CAGE CLAMP®

The WAGO CAGE CLAMP® connection is appropriate for solid, stranded and finely stranded conductors.

Note



Only connect one conductor to each CAGE CLAMP®!
Only one conductor may be connected to each CAGE CLAMP®.
Do not connect more than one conductor at one single connection!

If more than one conductor must be routed to one connection, these must be connected in an up-circuit wiring assembly, for example using WAGO feed-through terminals.

Exception:

If it is unavoidable to jointly connect 2 conductors, then you must use a ferrule to join the wires together. The following ferrules can be used:

Length:	8 mm
Nominal cross section _{max.} :	1 mm ² for 2 conductors with 0.5 mm ² each
WAGO product:	216-103 or products with comparable properties

1. For opening the CAGE CLAMP® insert the actuating tool into the opening above the connection.
2. Insert the conductor into the corresponding connection opening.
3. For closing the CAGE CLAMP® simply remove the tool. The conductor is now clamped firmly in place.

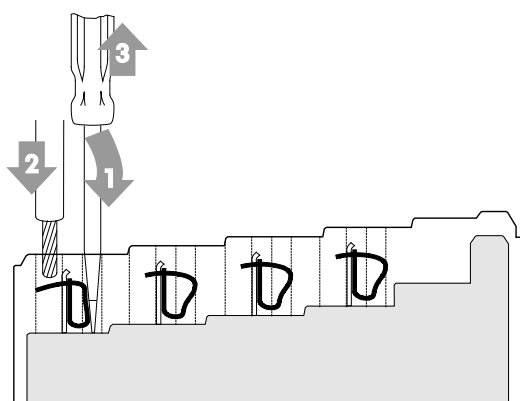

Figure 20: Connecting a Conductor to a CAGE CLAMP®

7 Use in Hazardous Environments

The **WAGO-I/O-SYSTEM 750** (electrical equipment) is designed for use in Zone 2 hazardous areas.

The following sections include both the general identification of components (devices) and the installation regulations to be observed. The individual subsections of the “Installation Regulations” section must be taken into account if the I/O module has the required approval or is subject to the range of application of the ATEX directive.

7.1 Marking Configuration Examples

7.1.1 Marking for Europe According to ATEX and IEC-Ex

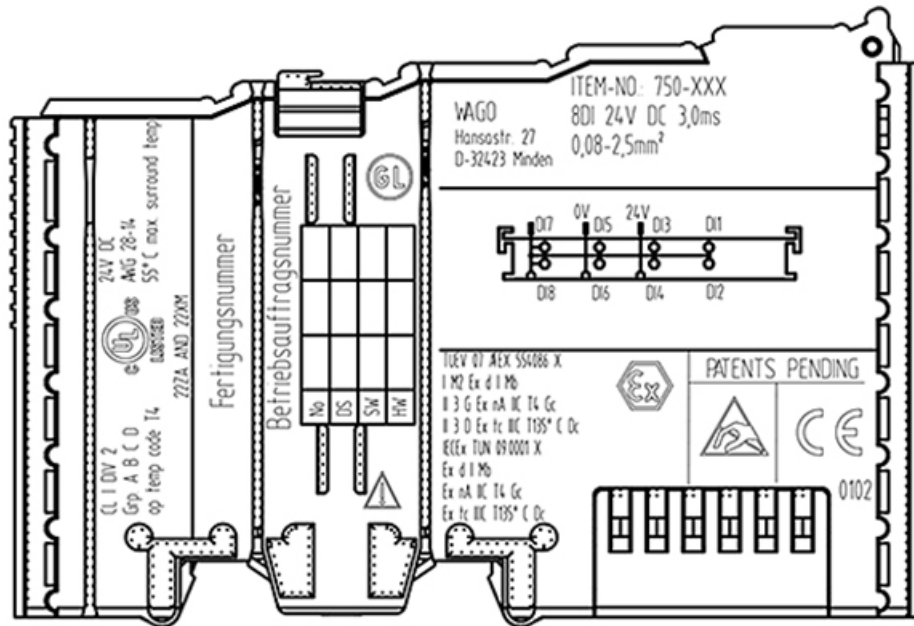

Figure 21: Side Marking Example for Approved I/O Modules According to ATEX and IECEx

TUEV 07 AEX 554086 X
I M2 Ex d I Mb
II 3 G Ex nA IIC T4 Gc
II 3 D Ex tc IIC T135° C Dc
IECEX TUN 09.0001 X
Ex d I Mb
Ex nA IIC T4 Gc
Ex tc IIC T135° C Dc



Figure 22: Text Detail – Marking Example for Approved I/O Modules According to ATEX and IECEx.

Table 16: Description of Marking Example for Approved I/O Modules According to ATEX and IECEx

Printing on Text	Description
TÜV 07 ATEX 554086 X IECEx TUN 09.0001 X	Approving authority and certificate numbers
Dust	
II	Equipment group: All except mining
3D	Category 3 (Zone 22)
Ex	Explosion protection mark
tc Dc	Type of protection and equipment protection level (EPL): protection by enclosure
IIIC	Explosion group of dust
T 135°C	Max. surface temperature of the enclosure (without a dust layer)
Mining	
I	Equipment group: Mining
M2	Category: High level of protection
Ex	Explosion protection mark
d Mb	Type of protection and equipment protection level (EPL): Flameproof enclosure
I	Explosion group for electrical equipment for mines susceptible to firedamp
Gases	
II	Equipment group: All except mining
3G	Category 3 (Zone 2)
Ex	Explosion protection mark
nA Gc	Type of protection and equipment protection level (EPL): Non-sparking equipment
nC Gc	Type of protection and equipment protection level (EPL): Sparking apparatus with protected contacts. A device which is so constructed that the external atmosphere cannot gain access to the interior
IIIC	Explosion group of gas and vapours
T4	Temperature class: Max. surface temperature 135°C

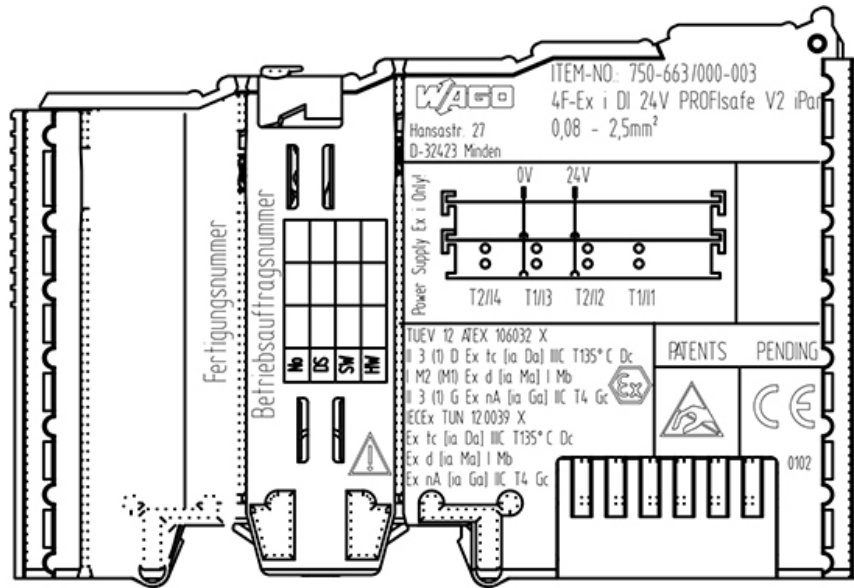

Figure 23: Side Marking Example for Approved Ex i I/O Modules According to ATEX and IECEx.

TUEV 12 ATEX 106032 X
 II 3 (1) D Ex tc [ia Da] IIC T135° C Dc
 I M2 (M1) Ex d [ia Ma] I Mb
 II 3 (1) G Ex nA [ia Ga] IIC T4 Gc 
 IECEx TUN 12.0039 X
 Ex tc [ia Da] IIC T135° C Dc
 Ex d [ia Ma] I Mb
 Ex nA [ia Ga] IIC T4 Gc

Figure 24: Text Detail – Marking Example for Approved Ex i I/O Modules According to ATEX and IECEx.

Table 17: Description of Marking Example for Approved Ex i I/O Modules According to ATEX and IECEx

Inscription Text	Description
TÜV 07 ATEX 554086 X IECEX TUN 09.0001X	Approving authority and certificate numbers
TÜV 12 ATEX 106032 X IECEX TUN 12.0039 X	
Dust	
II	Equipment group: All except mining
3(1)D	Category 3 (Zone 22) equipment containing a safety device for a category 1 (Zone 20) equipment
3(2)D	Category 3 (Zone 22) equipment containing a safety device for a category 2 (Zone 21) equipment
Ex	Explosion protection mark
tc Dc	Type of protection and equipment protection level (EPL): protection by enclosure
[ia Da]	Type of protection and equipment protection level (EPL): associated apparatus with intrinsic safety circuits for use in Zone 20
[ib Db]	Type of protection and equipment protection level (EPL): associated apparatus with intrinsic safety circuits for use in Zone 21
IIIC	Explosion group of dust
T 135°C	Max. surface temperature of the enclosure (without a dust layer)
Mining	
I	Equipment Group: Mining
M2 (M1)	Category: High level of protection with electrical circuits which present a very high level of protection
Ex d Mb	Explosion protection mark with Type of protection and equipment protection level (EPL): Flameproof enclosure
[ia Ma]	Type of protection and equipment protection level (EPL): associated apparatus with intrinsic safety electrical circuits
I	Explosion group for electrical equipment for mines susceptible to firedamp

Table 17: Description of Marking Example for Approved Ex i I/O Modules According to ATEX and IECEx

Gases	
II	Equipment group: All except mining
3(1)G	Category 3 (Zone 2) equipment containing a safety device for a category 1 (Zone 0) equipment
3(2)G	Category 3 (Zone 2) equipment containing a safety device for a category 2 (Zone 1) equipment
Ex	Explosion protection mark
nA Gc	Type of protection and equipment protection level (EPL): Non-sparking equipment
[ia Ga]	Type of protection and equipment protection level (EPL): associated apparatus with intrinsic safety circuits for use in Zone 0
[ia Gb]	Type of protection and equipment protection level (EPL): associated apparatus with intrinsic safety circuits for use in Zone 1
IIC	Explosion group of gas and vapours
T4	Temperature class: Max. surface temperature 135°C

7.1.2 Marking for America According to NEC 500

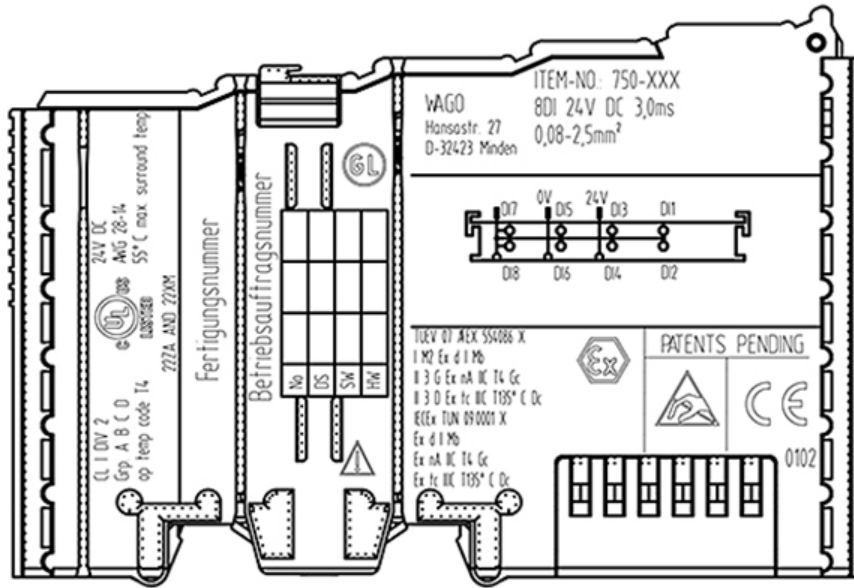

Figure 25: Side Marking Example for I/O Modules According to NEC 500

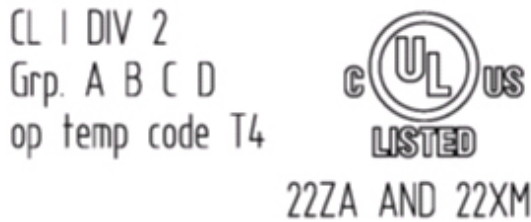

Figure 26: Text Detail – Marking Example for Approved I/O Modules According to NEC 500

Table 18: Description of Marking Example for Approved I/O Modules According to NEC 500

Printing on Text	Description
CL I	Explosion protection group (condition of use category)
DIV 2	Area of application
Grp. ABCD	Explosion group (gas group)
Op temp code T4	Temperature class

7.2 Installation Regulations

For the installation and operation of electrical equipment in hazardous areas, the valid national and international rules and regulations which are applicable at the installation location must be carefully followed.

7.2.1 Special Conditions for Safe Use (ATEX Certificate TÜV 07 ATEX 554086 X)

1. For use as Gc- or Dc-apparatus (in zone 2 or 22) the Field bus Independent I/O Modules WAGO-I/O-SYSTEM 750-*** shall be erected in an enclosure that fulfils the requirements of the applicable standards (see the marking) EN 60079-0, EN 60079-11, EN 60079-15 and EN 60079-31. For use as group I electrical apparatus M2 the apparatus shall be erected in an enclosure that ensures a sufficient protection according to EN 60079-0 and EN 60079-1 and the degree of protection IP64. The compliance of these requirements and the correct installation into an enclosure or a control cabinet of the devices shall be certified by an ExNB.
2. Measures have to be taken outside of the device that the rating voltage is not being exceeded of more than 40 % because of transient disturbances.
3. Dip-switches, binary-switches and potentiometers, connected to the module may only be actuated when explosive atmosphere can be excluded.
4. The connecting and disconnecting of the non-intrinsically safe circuits is only permitted during installation, for maintenance or for repair purposes. The temporal coincidence of explosion hazardous atmosphere and installation, maintenance resp. repair purposes shall be excluded. This is although and in particular valid for the interfaces “Memory-Card”, “USB”, “Fieldbus connection”, “Configuration and programming interface”, “antenna socket”, “D-Sub”, “DVI-port” and the “Ethernet interface”. These interfaces are not energy limited or intrinsically safe circuits. An operating of those circuits is in the behalf of the operator.
5. For the types 750-606, 750-625/000-001, 750-487/003-000, 750-484 and 750-633 the following shall be considered: The Interface circuits shall be limited to overvoltage category I/II/III (non mains/mains circuits) as defined in EN 60664-1.
6. For replaceable fuses the following shall be considered: Do not remove or replace the fuse when the apparatus is energized.
7. The following warnings shall be placed nearby the unit:
WARNING – DO NOT REMOVE OR REPLACE FUSE WHEN ENERGIZED
WARNING – DO NOT SEPARATE WHEN ENERGIZED
WARNING – SEPARATE ONLY IN A NON-HAZARDOUS AREA

7.2.2 Special Conditions for Safe Use (ATEX Certificate TÜV 12 ATEX 106032 X)

1. For use as Gc- or Dc-apparatus (in zone 2 or 22) the Field bus Independent I/O Modules WAGO-I/O-SYSTEM 750-*** Ex i shall be erected in an enclosure that fulfils the requirements of the applicable standards (see the marking) EN 60079-0, EN 60079-11, EN 60079-15 and EN 60079-31. For use as group I electrical apparatus M2 the apparatus shall be erected in an enclosure that ensures a sufficient protection according to EN 60079-0 and EN 60079-1 and the degree of protection IP64. The compliance of these requirements and the correct installation into an enclosure or a control cabinet of the devices shall be certified by an ExNB.
2. Measures have to be taken outside of the device that the rating voltage is not being exceeded of more than 40 % because of transient disturbances.
3. The connecting and disconnecting of the non-intrinsically safe circuits is only permitted during installation, for maintenance or for repair purposes. The temporal coincidence of explosion hazardous atmosphere and installation, maintenance resp. repair purposes shall be excluded.
4. For the type the following shall be considered: The Interface circuits shall be limited to overvoltage category I/II/III (non mains/mains circuits) as defined in EN 60664-1.

7.2.3 Special Conditions for Safe Use (IEC-Ex Certificate TUN 09.0001 X)

1. For use as Gc- or Dc-apparatus (in zone 2 or 22) the Field bus Independent I/O Modules WAGO-I/O-SYSTEM 750-*** shall be erected in an enclosure that fulfils the requirements of the applicable standards (see the marking) IEC 60079-0, IEC 60079-11, IEC 60079-15 and IEC 60079-31. For use as group I electrical apparatus M2 the apparatus shall be erected in an enclosure that ensures a sufficient protection according to IEC 60079-0 and IEC 60079-1 and the degree of protection IP64. The compliance of these requirements and the correct installation into an enclosure or a control cabinet of the devices shall be certified by an ExCB.
2. Measures have to be taken outside of the device that the rating voltage is not being exceeded of more than 40 % because of transient disturbances.
3. DIP-switches, binary-switches and potentiometers, connected to the module may only be actuated when explosive atmosphere can be excluded.
4. The connecting and disconnecting of the non-intrinsically safe circuits is only permitted during installation, for maintenance or for repair purposes. The temporal coincidence of explosion hazardous atmosphere and installation, maintenance resp. repair purposes shall be excluded. This is although and in particular valid for the interfaces “Memory-Card”, “USB”, “Fieldbus connection”, “Configuration and programming interface”, “antenna socket”, “D-Sub”, “DVI-port” and the “Ethernet interface”. These interfaces are not energy limited or intrinsically safe circuits. An operating of those circuits is in the behalf of the operator.
5. For the types 750-606, 750-625/000-001, 750-487/003-000, 750-484 and 750-633 the following shall be considered: The Interface circuits shall be limited to overvoltage category I/II/III (non mains/mains circuits) as defined in IEC 60664-1.
6. For replaceable fuses the following shall be considered: Do not remove or replace the fuse when the apparatus is energized.
7. The following warnings shall be placed nearby the unit:
WARNING – DO NOT REMOVE OR REPLACE FUSE WHEN ENERGIZED
WARNING – DO NOT SEPARATE WHEN ENERGIZED
WARNING – SEPARATE ONLY IN A NON-HAZARDOUS AREA

7.2.4 Special Conditions for Safe Use (IEC-Ex Certificate IECEx TUN 12.0039 X)

1. For use as Gc- or Dc-apparatus (in zone 2 or 22) the Field bus independent I/O Modules WAGO-I/O-SYSTEM 750-*** Ex i shall be erected in an enclosure that fulfils the requirements of the applicable standards (see the marking) IEC 60079-0, IEC 60079-11, IEC 60079-15, IEC 60079-31.
For use as group I electrical apparatus M2 the apparatus shall be erected in an enclosure that ensures a sufficient protection according to IEC 60079-0 and IEC 60079-1 and the degree of protection IP64.
The compliance of these requirements and the correct installation into an enclosure or a control cabinet of the devices shall be certified by an ExCB.
2. Measures have to be taken outside of the device that the rating voltage is not being exceeded of more than 40 % because of transient disturbances.
3. The connecting and disconnecting of the non-intrinsically safe circuits is only permitted during installation, for maintenance or for repair purposes. The temporal coincidence of explosion hazardous atmosphere and installation, maintenance resp. repair purposes shall be excluded.
4. For the type the following shall be considered: The Interface circuits shall be limited to overvoltage category I/II/III (non mains/mains circuits) as defined in IEC 60664-1.

7.2.5 Special Conditions for Safe Use according to ANSI/ISA 12.12.01

- A. “This equipment is suitable for use in Class I, Division 2, Groups A, B, C, D or non-hazardous locations only.”
- B. “This equipment is to be fitted within tool-secured enclosures only.”
- C. “WARNING Explosion hazard - substitution of components may impair suitability for Class I, Div. 2.”
- D. “WARNING – Do not disconnect equipment unless power has been switched off or the area is known to be non-hazardous” has to be placed near each operator accessible connector and fuse holder.
- E. When a fuse is provided, the following information shall be provided: “A switch suitable for the location where the equipment is installed shall be provided to remove the power from the fuse.”
- F. For devices with EtherCAT/Ethernet connectors “Only for use in LAN, not for connection to telecommunication circuits.”
- G. “WARNING - Use Module 750-642 only with antenna module 758-910.”
- H. For Couplers/Controllers and Economy bus modules only: The instructions shall contain the following: “The configuration interface Service connector is for temporary connection only. Do not connect or disconnect unless the area is known to be non-hazardous. Connection or disconnection in an explosive atmosphere could result in an explosion.”
- I. Modules containing fuses only: “WARNING - Devices containing fuses must not be fitted into circuits subject to over loads, e.g. motor circuits.”
- J. Modules containing SD card reader sockets only: “WARNING - Do not connect or disconnect SD-Card while circuit is live unless the area is known to be free of ignitable concentrations of flammable gases or vapors.”

Information



Additional Information

Proof of certification is available on request.

Also take note of the information given on the operating and assembly instructions.

The manual, containing these special conditions for safe use, must be readily available to the user.

List of Figures

Figure 1: View	15
Figure 2: Data Contacts	16
Figure 3: Power Jumper Contacts	17
Figure 4: CAGE CLAMP® Connectors	19
Figure 5: Display Elements	20
Figure 6: Schematic Diagram	21
Figure 7: Insert I/O Module (Example)	29
Figure 8: Snap the I/O Module into Place (Example)	29
Figure 9: Removing the I/O Module (Example)	30
Figure 10: Connector and Module	31
Figure 11: Assignment of Module to Connector Using Mini-WSB Tags	31
Figure 12: Attachment of Cable Binders	31
Figure 13: Assembling the Coding Fingers	32
Figure 14: Inserting the Coding Fingers	32
Figure 15: Plugging the Connector into Place	32
Figure 16: “Sure Match” Coding Fingers	33
Figure 17: Pulling the Pull Tab	34
Figure 18: Removing the Connector Without Tools	34
Figure 19: Removing the Connector Using a Screwdriver	34
Figure 20: Connecting a Conductor to a CAGE CLAMP®	35
Figure 21: Side Marking Example for Approved I/O Modules According to ATEX and IECEx	37
Figure 22: Text Detail – Marking Example for Approved I/O Modules According to ATEX and IECEx	37
Figure 23: Side Marking Example for Approved Ex i I/O Modules According to ATEX and IECEx	39
Figure 24: Text Detail – Marking Example for Approved Ex i I/O Modules According to ATEX and IECEx	39
Figure 25: Side Marking Example for I/O Modules According to NEC 500	42
Figure 26: Text Detail – Marking Example for Approved I/O Modules According to NEC 500	42

List of Tables

Table 1: Number Notation.....	8
Table 2: Font Conventions	8
Table 3: Legend for Figure “View”	15
Table 4: Legend for Figure “Power Jumper Contacts”	17
Table 5: Legend for Figure “CAGE CLAMP® Connectors”	19
Table 6: Legend for Figure “Display Elements”	20
Table 7: Technical Data – Device	22
Table 8: Technical Data – Supply	22
Table 9: Technical Data – Communication.....	22
Table 10: Technical Data – Inputs	22
Table 11: Technical Data – Field Wiring.....	22
Table 12: Technical Data – Power Jumper Contacts	22
Table 13: Technical Data – Data Contacts	23
Table 14: Technical Data – Climatic Environmental Conditions	23
Table 15: Input Bits	27
Table 16: Description of Marking Example for Approved I/O Modules According to ATEX and IECEx	38
Table 17: Description of Marking Example for Approved Ex i I/O Modules According to ATEX and IECEx	40
Table 18: Description of Marking Example for Approved I/O Modules According to NEC 500.....	42

WAGO Kontakttechnik GmbH & Co. KG
Postfach 2880 • D-32385 Minden
Hansastraße 27 • D-32423 Minden
Phone: +49/5 71/8 87 – 0
Fax: +49/5 71/8 87 – 1 69
E-Mail: info@wago.com
Internet: <http://www.wago.com>

